

GREEN PIN[®] PRODUCT CATALOGUE



Includes complementary products



KEY ICONS

Certificates

Depending on the type of product and certificate availability for a certain product, the below mentioned certificates are used in this catalogue. For more information see page 9.

Type 2.1	Works certificate to EN 10204	2.1
Type 2.2	Works certificate to EN 10204	2.2
Type 3.1	Inspection certificate to EN 10204	3.1
Type MTC a	Manufacturer test certificate	MTC ^a
Type MTC b	Manufacturer test certificate	MTC ^b
Type LROS	Proofload Statement	LROS
Type MPI a	Non-destructive testing report	MPI ^a
Type MPI b	Non-destructive testing report	MPI ^b
Type US a	Non-destructive testing report	US ^a
Type US b	Non-destructive testing report	US ^b
Type DNV GL 2.7-1 a	Type Approval certificate to DNV GL - ST - E271/E273	DNV GL 2.7-1 ^a
Type DNV GL 2.7-1 b	Type Approval certificate to DNV GL - ST - E271/E273	DNV GL 2.7-1 ^b
Type DNV GL CG3	Certificate Proof load witnessed and issued by DNV GL	DNV GL CG3
Type DNV GL 0377	Type Approval certificate to DNV GL - ST 0377 (former DNV 2.22)	DNV GL 0377
Type DNV GL 0378	Type Approval certificate to DNV GL - ST 0378 (former DNV 2.22)	DNV GL 0378
Type DGUV	DGUV Type test certificate to EN 1677	DGUV
Type CE	CE declaration of conformity	CE
Type BL	Break Load test certificate	BL
Type ABS PDA	Certificate of Product Design Assessment Approval	ABS PDA
Type ABS MA	Certificate of Manufacturing Assessment Approval	ABS MA

Conditions

Certificate types 2.1, 2.2, 3.1, MTC a, DNV GL 2.7-1 a, DNV GL 2.7-1 b, DNV GL 0377, DNV GL 0378, DGUV, ABS PDA, ABS MA and CE can be supplied at no extra charge. For all other certificates, additional costs will be charged.

Other

RFID Tag	RFID
CAD drawings	CAD
More info	INFO

Complementary product	C
-----------------------	---

GREEN PIN[®] PRODUCT CATALOGUE

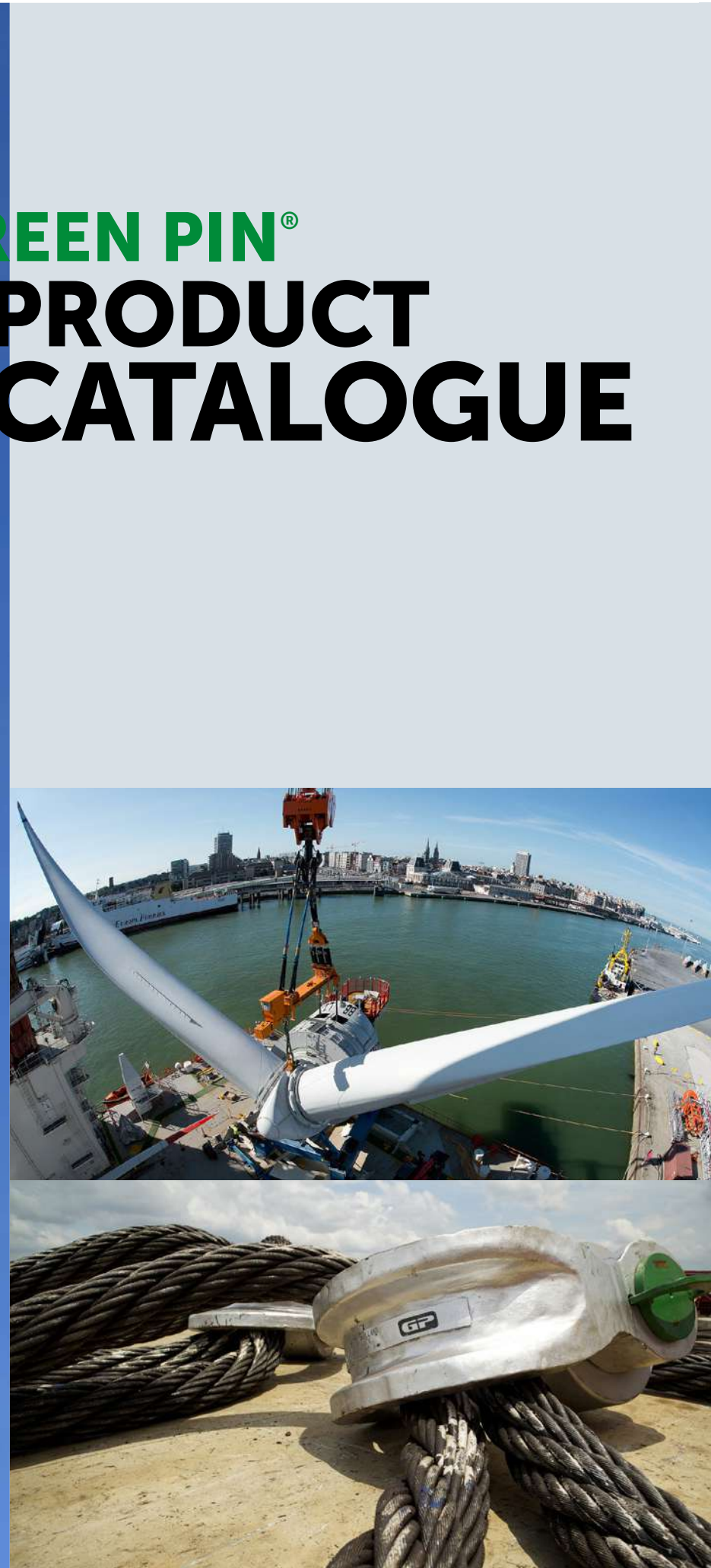

Green Pin® is the leading brand for premium quality lifting and lashing equipment including shackles, turnbuckles, hooks and fibre link chain. What makes it the leading brand? Only Green Pin® combines innovative, high-quality products with industry-leading availability and comprehensive, worldwide support. This unique combination means that with Green Pin® products you are always ready to get the job done. You are Green to Go.

Green to Quality

Work easier with Green Pin® products that are produced to perfection

To ensure reliability and quality, Green Pin® products tick all the boxes:

- Developed with a clear view of what you need. When cost-effectiveness was at the top of our customers' agendas, we developed the Green Pin Power Sling® Shackle. This product saves users up to 20% on wire rope costs - more than any competing product;
- Raw materials come from high quality suppliers who guarantee full traceability. For example, our steel is sourced from leading, fully certified European mills. And our Green Pin Tycan® high-performance chain is manufactured from 100% Dyneema®;
- Produced at automated production facilities to reduce the margins of error compared to other methods;
- Many products that conform to leading standards and which can be supplied with certificates from class societies such as DNV GL and Lloyd's.

Green to Speed

Order Green Pin® products from stock worldwide

Producing a good, reliable product is simply not good enough. You must be able to obtain the right products just when you need it: the success of the project depends on it. To ensure that success, Green Pin® offers unrivaled product availability:

- The wide Green Pin® assortment has an industry-leading stock availability of 99%;
- Over 900 distributors in more than 90 countries stock Green Pin® products. All were carefully selected for their sling-making expertise, the value-added services they provide and their stockholding capacity;
- We airfreight highly specialized products (which a distributor may not have in stock) to destination airports of choice within 72 hours* from one of our three distribution centres (Houston, Chicago and The Netherlands).

Green to Service

Rely on the best equipment and support. Guaranteed

Green Pin® products are made to meet the demands of the most complex lifting projects in the world. These projects usually require product information of the utmost precision, which often leads to in depth questions about the characteristics and application of Green Pin® products. Green Pin® therefore offers:

- CAD-drawings and technical documentation that are distinguished by their accuracy;
- A Technical Helpdesk that provides comprehensive answers swiftly;
- Technical training to provide insights into the benefits of our products and the different ways to apply them.

* A different transport duration applies to airfreight to New Zealand and Australia



Green Pin® History

Green Pin® traces its origin back to 1922, when Dirk van Beest started to manufacture the shackles that would later be branded Green Pin®. He did so at the home of the Dutch dredging industry: Sliedrecht, close to the Port of Rotterdam. Dirk van Beest – a diligent, hardworking man – was passionate about creating 100% failsafe products in combination with a full-service attitude. With his focus, the company was able to grow quickly, in tandem with the international growth of the Dutch dredging and maritime industry.

Today, Green Pin® is still part of the family-owned Van Beest Group. It is headquartered in Sliedrecht, the Netherlands, and has branches in the United States (Houston and Chicago), France, Germany and Norway.

Brand mergers: Green Pin®, Excel® and Tycan®

In 2018, the Tycan® and Excel® brands were merged into Green Pin®. This created one, big premium brand – Green Pin® – for all below-the-hook fittings. Van Beest will continue to sell its full product range – Green Pin Tycan® fibre chain, Green Pin® rope fittings and Green Pin® chain fittings – under the new, premium brand name through its existing distributor network.

Excel® was a premium quality brand for chain fittings, manufactured in France since the mid-1960's. Van Beest acquired the Excel® brand and its production facilities in 2007. Van Beest will continue to manufacture Green Pin® (formerly Excel®) chain fittings at its current production location in France. The transition period of replacing Excel® markings and logos on physical products will take several years. As part of the transition, the colour of grade 8 former Excel® products will change to white under the Green Pin® brand. These products were previously yellow or red. For this reason, you will see that the finish on the product pages of grade 8 Green Pin® (formerly Excel®) chain fittings is specified as "red", "yellow" or "white". Grade 10 products will remain blue, the same as before. After the transition period, the Excel® name and brand will cease to exist.

Tycan® is a premium quality, fibre link chain that has all the performance and flexibility of steel chain but is a fraction of the weight. Van Beest obtained the Tycan® brand through its acquisition of the Norwegian company Load Solutions in September 2017. Due to the novelty of Tycan®'s product range, Tycan® will continue to exist as a special sub-brand within the scope of the Green Pin® brand. All Green Pin® products related to fibre technology will therefore be known as Green Pin Tycan®.



Complementary products

In addition to the Green Pin® assortment of chain and rope fittings, Green Pin®'s corporate parent Van Beest offers complementary products (such as wire rope thimbles, sleeves, general hardware, etc.) to make a lifting assembly complete. They are all produced to the specifications indicated in this catalogue and are subject to the quality control of Van Beest. Complementary products are highlighted on the product pages of the catalogue with this icon .

Memberships

Van Beest is a member of several organizations which promote common interests in our industry. Companies with similar interests come together to share ideas and solutions for industry issues. These organizations spread (technical) information via publications, internet and meetings, and represent the interests of their members on a collective basis. Some of them also organize trade missions, seminars, workshops, member meetings and collective participation in exhibitions worldwide.



Where to buy Green Pin® products

In addition to its premium quality and service, Green Pin® is known for its unrivalled availability. Green Pin® is available from stock at our distributors in over 90 countries worldwide.

To find the distributor nearest you, please contact us at: sales@vanbeest.nl



References

Some companies that use our products in projects:

- ADNOC
- Aker Marine Contractors
- ALE
- Allseas
- Bechtel Corporation
- Boskalis
- Buckner Heavylift Cranes
- Caterpillar
- EDF
- ExxonMobil
- Fluor
- General Electric
- Heerema Marine Contractors
- Hyundai Heavy Industries
- InterMoor
- Jumbo
- Kiewit
- Lamprell
- Liebherr
- Mammoet
- Manitou
- McDermott
- NOV
- Oceaneering
- Rio Tinto
- Saipem
- Saudi Aramco
- Siemens
- Shell
- SpaceX
- Subsea 7
- Tata
- TechnipFMC
- Total
- US Steel
- Vestas

INTRODUCTION

General

In case you do not use the products yourself but are reselling these as part of a manufactured product, please take our general cautions and warnings into account and make these known to your customers as well. In any case, we do not accept any responsibility or liability, nor can we be held responsible for any misuse or damage with, by or at your customers due to negligent use.

Definitions

Material

Various raw materials are used for the production of shackles, hooks and other lifting devices, depending on the use of the finished product. The following raw materials may be used:

- Mild steel, untreated, grade 3;
- High tensile steel, untreated, or normalized, grade 4;
- High tensile steel, quenched and tempered, grade 6;
- Alloy steel, quenched and tempered, grade 8;
- Alloy steel, quenched and tempered, grade 10;
- Stainless steel AISI316L or AISI316, grade 5.

Load

Following terms are used to define a load:

- Working Load Limit or WLL: the maximum load the product is designed to support, in general use and in in-line lifting.
- Proof Load or PL: this is the load applied on proof testing the product. At this load the product may not show visual deformation. For information about the proof load applied, we refer to the separate paragraph on testing.
- Minimum Breaking Load or MBL: the minimum load at which the product may fail or no longer support the load. Where applicable the MBL is specified.
- Shock Load: a sudden impact of the load on the lifting product. Shock loads are to be avoided at all times since they increase the stress on the product significantly and may affect its product life.

The unit that is used in this catalogue to indicate WLL, PL and MBL is t, which stands for metric ton.

Safety factor

This indicates the ratio between the MBL and the WLL. For the standard range of Green Pin® shackles, for example, the safety factor is 6:1. This means that the shackle may only break once it is overloaded by a factor of at least 6 times its designed WLL. Green Pin® chain fittings have a safety factor of 4:1.

Product dimensions

All product dimensions mentioned in this catalogue are nominal dimensions. Product design, materials and/or specifications may be changed without prior notification.

Finish

Products can have the following finish:

- Self coloured: the product is delivered in the condition as it has been forged or machined and has undergone no specific finish treatment.
- Electro-galvanized: the finished product is electro-galvanized according to the customary standards. The thickness of the galvanization is at least 5 µm.
- Hot dipped galvanized: the finished product is hot dipped galvanized according to the customary standards. The thickness of the coating is at least 70 µm.
- Painted: the finished product is painted in a specific colour.
- Polished: stainless steel products are polished.

Standard

These refer to the specific standards indicated for the product.

Temperature range

This indicates the temperature range at which the product can be used. Beyond the advised temperature range the WLL of a product may be affected.

Abbreviations

The following abbreviations are used in this catalogue:

Product class abbreviations (for example, G-4161)

C	Carbon steel
A	Alloy steel
R	Stainless steel
S	Self coloured
P	Painted
E	Electro-galvanized
G	Hot dipped galvanized

Product name abbreviations (for example, Green Pin® Bow Shackle BN)

BN	Bolt & Nut, or safety bolt	HH	Hook-Hook
CL	Clevis	HK	Hook
CP	Cotter Pin	H-type	Horizontal
D	D-Handle	JJ	Jaw-Jaw
E	Eye	ROV	Remotely Operated Vehicle
EE	Eye-Eye	S	Shackle
EJ	Eye-Jaw	S/S	Stainless Steel
EH	Eye-Hook	SC	Screw Collar, or Screw Pin
F	F-Handle	SCL	Swivel Clevis
FN	Fixed Nut	SE	Swivel Eye
FP	Flush Pin	SQ	Square headed Screw Pin
GR10	Grade 10	U-type	Universal (Horizontal and Vertical)
GR5	Grade 5	V-type	Vertical
GR8	Grade 8		

Certificates

Our company has been ISO certified by Lloyd's; currently we are ISO 9001-2015 certified. Depending on the type of product and certificate availability for a certain product, below mentioned certificates can be provided.

Type 2.1	2.1	Works certificate to EN 10204 Statement of compliance with the order.
Type 2.2	2.2	Works certificate to EN 10204 Statement of compliance with the order, stating the results of non-specific inspection.
Type 3.1	3.1	Inspection certificate to EN 10204 Statement of compliance with the order, stating the results of material specific inspection. This includes chemical composition and mechanical properties at component level.
Type MTC a	MTC ^a	Manufacturer test certificate Statement of compliance with the order, stating the results of proof load testing samples of a production batch. Products are not individually tested.
Type MTC b	MTC ^b	Manufacturer test certificate Statement of compliance with the order, stating the results of individual proof load testing.
Type LROS	LROS	Proofload Statement Statement of witness of proof load testing and visual examination by a surveyor from Lloyds Register, stating the results of individual proof load testing.
Type MPI a	MPI ^a	Non-destructive testing report Statement of compliance with the order, stating the results of Magnetic Particle Inspection (M.P.I.) in accordance with EN 10228-1 on samples of a production batch. Products are not individually tested.
Type MPI b	MPI ^b	Non-destructive testing report Statement of compliance with the order, stating the results of individual Magnetic Particle Inspection (M.P.I.) in accordance with EN 10228-1.

Table continues on next page

Type US a	US ^a	Non-destructive testing report Statement of compliance with the order, stating the results of Ultrasonic Inspection (U.S.) in accordance with EN 10228-3 on samples of a production batch. Products are not individually tested.
Type US b	US ^b	Non-destructive testing report Statement of compliance with the order, stating the results of individual Ultrasonic Inspection (U.S.) in accordance with EN 10228-3.
Type DNV GL 2.7-1 a	DNV GL 2.7-1 ^a	Type Approval certificate to DNV GL 2.7-1 Green Pin® Standard Shackles, Green Pin Polar® Shackles, DNV GL Master links and DNV GL Master link assemblies are DNV GL Type approved to DNV GL standards DNVGL-ST-E271-2.71 Offshore containers and DNVGL-ST-E273 Portable offshore units. DNV GL Type approval certificates TAS000011V and TAS000013Z.
Type DNV GL 2.7-1 b	DNV GL 2.7-1 ^b	Type Approval certificate to DNV GL 2.7-1 Statement of compliance with the order, of Green Pin® Standard Shackles and Green Pin Polar® Shackles, DNV GL Type approved to DNV GL standards DNVGL-ST-E271-2.71 Offshore containers and DNVGL-ST-E273 Portable offshore units. Stating the results of proof load testing samples of a production batch. Products are not individually tested.
Type DNV GL 0377	DNV GL 0377	Type Approval certificate to DNV GL 0377 Green Pin Power Sling® shackles are DNV GL Type approved to DNV GL Standard DNVGL-ST-0377 Standard for shipboard lifting appliances. DNV GL Type approval certificate TAS000018M. Former DNV Certification No 2.22, Lifting Appliances – Application – Loose gear for offshore cranes.
Type DNV GL 0378	DNV GL 0378 DNV GL CG3	Type Approval certificate to DNV GL 0378 Green Pin® Standard Shackles, Green Pin Polar® Shackles and Green Pin Power Sling® shackles are DNV GL Type approved to DNV GL Standard DNVGL-ST-0378 – Standard for offshore and platform lifting appliances. DNV GL Type approval certificates TAS00001H7 and TAS000018M. Former DNV Certification No 2.22, Lifting Appliances – Application – Loose gear for offshore cranes.
Type DGUV	DGUV	DGUV Type test certificate to EN 1677 Many Green Pin® chain sling components have a DGUV type test certificate. Tests are based on GS-OA-15-05:2012-05: Principles for the testing and certification of chains and chain components. These components are Type approved to EN 818-2 or EN 1677 and are entitled to be marked H94.
Type CE	CE	CE declaration of conformity CE Declaration of Conformity in accordance with annex IIA of the machine directive 2006/42/EC and the latest amendments.
Type BL	BL	Break Load test certificate A certificate with the actual breaking load experienced on tested samples.
Type ABS PDA	ABS PDA	Certificate of Product Design Assessment Approval The Green Pin® Standard Shackles G-4161, G-4163, G-4151, G-4153; The Green Pin Polar® Shackles G-5163 and the Green Pin Super® Shackles G-5261 and G-5263 are ABS Type Approved. Intended service: Loose Gear Items. Use on Lifting Equipment. ABS PDA certificates 18-HS1737328-PDA, 18-HS1737330-PDA and 18-HS1737332-PDA.
Type ABS MA	ABS MA	Certificate of Manufacturing Assessment Approval ABS MA certificate 18-RO 3524956.

Conditions

Certificate types 2.1, 2.2, 3.1, MTC a, DNV GL 2.7-1 a, DNV GL 2.7-1 b, DNV GL 0377, DNV GL 0378, DGUV, ABS PDA, ABS MA and CE can be supplied at no extra charge. For all other certificates, additional costs will be charged.

Free of Charge:

2.1 2.2 3.1 MTC^a DNV GL 2.7-1^a DNV GL 2.7-1^b DNV GL 0377 DNV GL 0378 DGUV CE ABS PDA ABS MA

With additional Charges:

MTC^b LROS MPI^a MPI^b US^a US^b DNV GL CG3 BL

On request the proof load test certificates can be supplied surveyed by an official classification society, such as LROS, DNV GL, BV, ABS or any other officially certified inspection body. Specific details of certificate availability can be found in each product chapter. Please verify your certification requirements at the time of order. For more information and specifications, see the table below for an overview of the different test methods.

Test method	Test type	Test description	Document
Visual inspection	Non Destructive	The products are inspected and approved by our QC-department. The products are inspected and approved by our QC-department, stating the results of non-specific inspection.	2.1 2.2
Material specific inspection	Destructive	The material of the products is inspected. This includes chemical composition and mechanical properties at component level.	3.1
Proof Load test	Non Destructive	Samples of a production batch of products are proof load tested. Products are not individually tested. All products of a production batch are individually proof load tested.	MTC ^a MTC ^b
Magnetic Particle inspection	Non Destructive	Samples of a production batch of products are Magnetic Particle Inspection (M.P.I.) tested in accordance with EN 10228-1. Products are not individually tested. All products of a production batch are individually Magnetic Particle Inspection (M.P.I.) tested in accordance with EN 10228-1.	MPI ^a MPI ^b
Ultrasonic inspection	Non Destructive	Samples of a production batch of products are Ultrasonic Inspection (U.S.) tested in accordance with EN 10228-3. Products are not individually tested. All products of a production batch are individually Ultrasonic Inspection (U.S.) tested in accordance with EN 10228-3.	US ^a US ^b
Break Load test	Destructive	Samples of a production batch are break load tested.	BL

CAD drawings

Green Pin® products are used in a wide variety of applications; from a simple lift to move an item from A to B in a workplace, to very complex lifting systems for offshore applications. In the latter case, engineers use computer programs like AutoCAD to develop a 2D or 3D specification of the entire system.

For standard products engineers normally use a CAD drawing library. The use of these kinds of libraries saves considerable design time and costs. And of course it prevents mistakes that may occur whilst copying data from a product catalogue into the design program.

To help engineers, Green Pin® has made CAD drawings available in various formats on the Green Pin® website (www.greenpin.com). These drawings can be integrated in almost every design program. Further details can be obtained through our website: www.greenpin.com/cad

CAD

In the product chapters the CAD icon indicates that cad drawings are available.

RFID

RFID

Green Pin® offers an identification solution with an easily accessible Radio Frequency Identification (RFID) chip in our range of Green Pin® Shackles. The RFID icon in the product chapters indicates that the products can be equipped with a countersunk RFID chip.

For more information see page 20.

INFO

More information

For some products we provide detailed technical information on our website. In the product chapters the INFO icon indicates there is extra information on this product available at www.greenpin.com/FAQ

General cautions and warnings

All WLL's indicated in this catalogue or in other Green Pin® literature or publications are only applicable to recently-supplied, new and unused products used under prescribed operating conditions. Any extreme circumstances or shock loading that occur during use must be taken into account when specifying the products to be used.

The WLL should be applied in in-line lifting. Overloads must be avoided. Side loads should be avoided too, as the products are not designed for this purpose and the application of a side load may significantly decrease product life. The WLL of the product represents the limit in static use. In case of dynamic use (breaking, accelerations, shocks), the effective stress on the product increases significantly which can lead to product failure.

Products must be regularly inspected in accordance with the safety standards valid in the country of use. This is required because the products in use may be affected by wear, misuse, overloading etc. which may lead to deformation and alteration of the material structure. Inspection should take place at least every six months and more frequently when the products are used in severe operating conditions.

Green Pin® is constantly improving products to make sure they meet the latest industry standards. Therefore some dimensions or product markings may differ from those stated in this catalogue. The characteristics mentioned in this catalogue or in other Green Pin® literature or publications are given merely as an indication. Green Pin® reserves the right to make any suitable modification to any product, even after acceptance of the customer order. The essential characteristics and performances of the products shall not be negatively affected by such modifications. Any critical dimensions or characteristics should be verified with our engineering department before ordering the product.

Green Pin® products are typically used to transfer loads during lifting, lashing or towing. These fittings are usually combined with steel wire rope, chain or synthetic rope to form a lifting sling. You must therefore conduct the following verifications to safely use the products:

Verification before first use

Before first use of the sling it should be ensured that:

- The sling meets the exact requirements specified in the order;
- The valid manufacturer certificate and CE declaration are at hand;
- The identification and the WLL mentioned on the sling correspond to the information stated on the certificate;
- Full details of the sling (components, diameter, number of legs, angle, grade) are recorded in the register of lifting equipment;
- The users of the sling have received appropriate instruction and training.

Verification before each use

Before each use the sling should be visually inspected for obvious damage or deterioration. If faults are found during this inspection, the sling should be withdrawn from service and referred to a competent person for thorough examination. Some parts can be replaced or the complete sling can be discarded.

A thorough inspection should be carried out by a competent person at intervals not exceeding six months and more frequently when the slings are used in severe operation conditions. Records of such inspections should be maintained. Slings should be thoroughly cleaned to remove any oil, dirt or rust prior to inspection. Any cleaning method which does not damage the material is acceptable. Avoid the use of acids, overheating, removal of metal or movement of metal which may cover cracks or surface defects.

The sling should be inspected throughout its full length to detect any evidence of wear, distortion or external damage.

Any replacement component or part of the sling should be in accordance with the appropriate European Standard or the safety standards given in the country of use for that component or part. If a chain link in one of the legs of a chain sling is damaged, then the entire chain leg should be replaced. The repair of a link in a welded chain sling should exclusively be carried out by the chain manufacturer using the adequate welding process. Components showing any defects should be discarded and replaced. When replacing a mechanically assembled component, always use a replacement component that meets the certification requirements of the sling.

Handling of the load

- It is important to check the sling before lifting. Check if the manufacturer of the load indicates any specific instructions for the lifting of the load. Before starting the lift, make sure that the load is free to move and is not bolted down. Also check if no loose objects could fall down from the load. The path between the current location of the load and the new one must be free.
- The weight of the load must be known in order to select a sling with the correct WLL. If the weight of the load is not marked, the information should be obtained from the consignment notes, manuals or drawings, or assessed by calculation.
- Please observe the centre of gravity of the load. To prevent any tilting or toppling, the following conditions should be met:
 - for single leg slings and endless slings the lifting point should be positioned directly above the centre of gravity.
 - for two leg slings the lifting points should be positioned on both sides of, and higher than, the centre of gravity.
 - for three and four leg slings the lifting points should be distributed in a plane around the centre of gravity. Distribute the weight evenly over the lifting points, which should be placed higher than the centre of gravity.
- When using multi leg slings make sure that the angles between the lifting points and sling legs are within the range marked on the sling. The angle β , which is the angle between the sling leg and the vertical, should never exceed 60°. Details about load reductions for slings at certain angles can be found in the tables corresponding to the relevant chain grade.
- Use the below reduction table if a multi leg sling is not used for the purpose for which it has been designed, for example for a lifting operation with fewer legs than the number of legs of the sling:

Types of chain sling	Number of legs used	Factor to apply to marked WLL
Two-leg	1	1/2
Three- and four-leg	2	2/3
Three- and four-leg	1	1/3

- The sling should at least have a WLL equal to or greater than the weight to be lifted.
- Ensure that the load to be moved is able to resist both the vertical and horizontal force without being damaged.
- A suspended load should not be left unattended.
- Riggers should be aware of the risks and dangers of shock loading which may break the sling. The load should always be lifted and lowered slowly.

Method of connection

- A sling is usually attached to the load with endfittings such as hooks and/or links.
- The components should be used for in-line loading only in order to avoid bending.
- The lifting points fixed on the load should be seated well in the load bearing part of the hook (never on the tip of the hook or wedged in the opening of the hook).
- We refer to the detailed warnings of each component in the product chapters.

Symmetry of loading

The WLL values mentioned in our catalogue for each grade have been determined on the basis that the loading of the sling is symmetrical. This means that when the load is lifted the sling legs are symmetrically distributed in the plane and all legs of the sling have the same angles to the vertical. For chain slings refer to EN 818-6:2000+A1:2008 for more details.

The loading can be assumed to be symmetric if all of the following conditions are met:

- the load is less than 80% of marked WLL and
- sling leg angles to the vertical are all more than 15° and
- sling leg angles to the vertical are all within 15° to each other and
- in the case of three- and four- leg slings, the plane angles are within 15° of each other.

If one of the above parameters is not met, the loading should be considered to be asymmetric and the lift should be referred to a competent engineer to establish the safe rating for the sling. Alternatively, in the case of asymmetric loading, the sling should be derated to half the marked WLL. If the load tends to tilt during the lift, it should be lowered and the attachments changed by repositioning the attachment points or by using compatible shortening devices. The safety factor of 5 or 6 on the individual components is designed for safety only. Never exceed the indicated WLL.

Safety of lift

Hands and other body parts should be kept away from the chain to prevent injuries. The load should be lifted slowly until the sling leg is taut. As soon as the load is slightly raised, check that it is secure and has the desired position. Refer to ISO 12480-1 for planning and management of the lifting operation and for a safe way of executing it. Never move the load over people during the lift.

Lowering the load

The point of destination of the load should be prepared and should be adapted to the weight and shape of the load. The access to this site must be clear of any unnecessary obstacles and people. The load should be lowered carefully. Avoid trapping the sling beneath the load as this may cause damage to the load or sling. Before taking the tension off the sling legs, the load should be checked to ensure that it is properly supported and stable. The sling should be removed by hand and not with the lifting device. The load should not be rolled off the sling as this may damage the sling.

Storage of slings

When not in use slings should be kept on a properly designed rack. They should not be left lying on the ground where they may be damaged. If the slings are left suspended from a crane hook, the sling hooks should be engaged in an upper link to reduce the risk of sling legs swinging freely or snagging. If the slings are out of use for some time they should be cleaned, dried and protected from corrosion, e.g. lightly oiled.

Maintenance

Slings must be regularly inspected in accordance with the safety standards valid in the country of use.

A competent engineer should examine the sling, observing the following:

- the sling markings (ID, WLL) must be legible;
- there may be no distortion of the upper or lower end fittings;
- sling leg stretch and wear may not exceed the tolerances.

If the identification tag of the sling is missing and the necessary information is not marked on the sling itself, the sling should be withdrawn from service. Use original Green Pin® spare kits to replace parts (such as a load pin or the latch of a hook) or if a load pin is misused, damaged or distorted.

Limitations in use

- Never modify components by welding, heat treating, grinding or any other process. It could alter their mechanical and/or chemical characteristics;
- Consult Green Pin® if the sling is to be exposed to highly concentrated chemicals. Green Pin® products may not be used under chemical influences such as acids or alkaline solutions;
- The rating of lifting accessories in European Standards assumes the absence of exceptionally hazardous conditions. This concerns offshore activities, lifting of persons and lifting of potentially dangerous loads. In such cases the degree of hazard should be assessed by a competent engineer and the WLL adjusted accordingly;
- If a product is used under extreme temperature conditions, the WLL must be reduced. We refer to the relevant product chapter in this catalogue for guidance on use at extreme temperatures.

Conversion factors

		To convert	
from	to	multiply by	
Length			
mm	inch	0.0393701	
inch	mm	25.4	
Mass			
US tons	metric tons	0.9071847	
metric tons	US tons	1.1023113	
metric tons	pounds	2204.6226218	
pounds	metric tons	0.0004536	
metric tons	kilogram	1000	
kilogram	metric tons	0.001	
metric tons	kilo Newton	9.8066500	
kilo Newton	metric tons	0.1019716	
pounds	kilogram	0.4535924	
kilogram	pounds	2.2046226	
Torque			
Newton meter	foot pound-force	0.7375621	
foot pound-force	Newton meter	1.3558180	





1 Shackles	18	1
2 Thimbles	76	2
3 Wire Rope Clips	86	3
4 Sleeves	92	4
5 Sockets	96	5
6 Turnbuckles	108	6
7 Links	126	7
8 Swivels	142	8
9 Hooks	148	9
10 Lifting Eyes	172	10
11 Loadbinders	186	11
12 Chain	194	12
13 Shortening Clutches	198	13
14 Lifting Clamps	202	14
15 Blocks	208	15
16 General Hardware	216	16
17 Spare Parts	228	17
18 Stainless Steel Products	240	18

SHACKLES



Applications

Shackles are used in lifting operations and static systems as removable links to connect (steel) wire rope, chain and other fittings. Screw pin shackles are used mainly for non-permanent applications. Safety bolt and fixed nut shackles are used for long-term or permanent applications or where the load may slide on the pin causing rotation of the pin. Chain- or dee shackles are mainly used on one-leg systems whereas anchor- or bow shackles are mainly used on multi-leg systems.

Range

Green Pin® offers a wide range of bow and dee shackles for a variety of applications. The range stretches from WLL 0.33t to 3000t. This provides our customers with a very extensive range to choose a shackle that suits their application best. Most of the shackles are directly available from stock. Furthermore, shackles can be supplied to many standards such as the US Federal Specification RR-C-271, EN 13889, British Standard 3032, DIN 82101 etc. Additionally we offer a wide range of general commercial shackles, which are not suitable for lifting but merely for fixing purposes. Van Beest offers a wide range of other shackles to complement the Green Pin® assortment.

Design

All Green Pin® shackles have a specific design for a specific application. Some examples are:

- Green Pin Super® Shackles which are made out of grade 8 steel. They are designed to be used in confined spaces. The higher material strength is used to reduce the physical dimensions of the product whilst maintaining its WLL and functionality;
- Green Pin Polar® Shackles are for use in extreme climatic conditions with material properties guaranteed up to temperatures of -60°C;
- Green Pin Power Sling® Shackles are designed to provide a better radius to the sling it lifts. A bigger radius increases the life span of the sling significantly;
- Another example of a functional design is a shackle pin with a square sunken hole. Because of the flat head there is less risk of the shackle getting caught in a net or a line.

These are all examples of highly functional designs, to optimize the use of the Green Pin® shackles in daily use.

Shackles used for lifting applications are generally marked with:

- | | |
|--|---|
| • Working Load Limit | - e.g. WLL 25 T |
| • manufacturer's symbol | - e.g. GP |
| • traceability code | - e.g. HA indicating a particular batch |
| • steel grade | - e.g. 4, 6, 8 |
| • CE conformity code (Conformité Européenne) | - CE |

Green Pin® Shackles meet all relevant requirements of the Machinery Directive 2006/42/EC and its latest amendments.

Finish

Shackles supplied by Green Pin® can be hot dipped galvanized, electro-galvanized, painted or self coloured, depending on the type of shackle and its application. You can find the finish of each type of shackle in the product section further on.



Certification

Upon request at time of order, all load rated shackles can be supplied with any of the following documents or certificates:

Free of Charge:

2.1 2.2 3.1 MTC[®] DNV GL 2.7-1[®] DNV GL 2.7-1[®] DNV GL 0377 DNV GL 0378 CE ABS PDA ABS MA

With additional Charges:

MTC[®] MPI[®] MPI[®] US[®] US[®] DNV GL CG3 BL

On request the proof load test certificates can be supplied surveyed by an official classification society, such as LROS, DNV GL, BV, ABS or any other officially certified inspection body. Please verify your certification requirements with Green Pin[®] at the time of order.

Green Pin[®] Bow Shackles, Green Pin[®] Dee Shackles and Green Pin Polar[®] Shackles are DNV GL type approved. These shackles carry two DNV GL type approval certificates that show compliance with:

- DNVGL-ST-E271-2.71 Offshore Containers
- EN 12079-2 Offshore containers and associated lifting sets
- EN 13889 Forged steel shackles for general lifting purposes
- IMO/MSC Circular 860
- US Federal Specification RR-C-271
- DNV GL-ST-E273 Portable Offshore Units
- DNV GL Standard No. 0378 Offshore and Platform Lifting Appliances

The certificates TAS000011V and TAS00001H7 confirm that Green Pin[®] standard shackles and Green Pin Polar[®] Shackles meet the requirements set in the latest version of the above mentioned DNV GL standards.

The Green Pin Power Sling[®] Shackles are DNV GL type approved. This DNV GL type approval certificate is in compliance with:

- DNV GL Standard for Certification No. 0377 Standard for Shipboard Lifting Appliances
- DNV GL Standard for Certification No. 0378 Offshore and Platform Lifting Appliances

The TAS000018M certificate confirms that Green Pin Power Sling[®] Shackles meet the requirements stated in the latest version of the above-mentioned DNV standards.

Green Pin[®] Shackles G-4161, G-4163, G-4151, G-4153, G-5163, G-5261 and G-5263 are ABS Type Approved. The shackles have a Product Design Assessment Approval and a Manufacturer Assessment Approval Certificate. The shackles are type approved to be used as lifting gear or to be used as lifting device.

Fixed Nut Shackles

Shackles can also be used in more permanent constructions. These can be subject to dynamic loads and/or extreme vibrations. In such applications there is a risk that, over time, the nut may start to move over the thread. We offer our range of Green Pin[®] Fixed Nut Shackles to avoid this risk. Green Pin[®] Standard, Polar[®] and Super[®] shackles can be equipped with an extra AISI 316 securing bolt that is drilled through the nut and shackle pin. This securing bolt is fastened with two sets of Nord-Lock[®] washers and a securing nut. This will keep the shackle nut in position. The Nord-Lock wedge-locking washers lock when subjected to extreme vibration or dynamic loads.

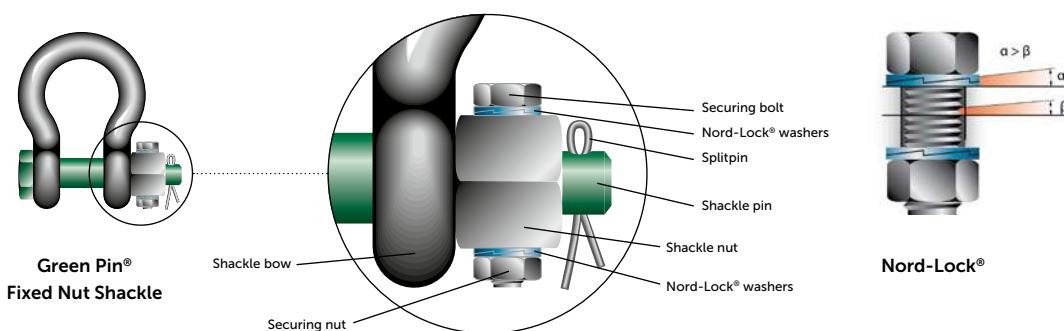

Green Pin® Shackles with RFID

All lifting equipment requires regular inspection. Tracking and filing reports on paper can be a time consuming task. Green Pin® offers a solution with an easily accessible RFID (Radio Frequency Identification) chip in our range of Green Pin® Shackles. This RFID chip responds to a radio-signal that is transmitted by a reader. Each chip has a unique number and this number links the individual shackle to a record in an inspection management system. The chips are impact resistant and durable and they are countersunk into the end of the shackle pin. The chips are NFC (Near Field Communication) compatible, allowing users to scan, identify and track the shackles with the latest generation of NFC compatible smartphones.

Green Pin® offers the option of RFID implementation in all Green Pin® shackles with a minimum pin diameter of 28mm.

- **RF Protocol :** ISO 15693
- **Operating Frequency :** HF – 13.56 MHz



Testing

Generally load rated products are Proofload tested, and certificates can be supplied upon request. For specific information on certificates we refer to the separate paragraph on certification.

Green Pin® shackles are Proofload tested at the following loads:

working load limit	Green Pin® Bow or Dee Shackles Polar® Shackles Heavy Duty Shackles BigMouth® Bow Shackle proof load	Green Pin Super® Shackles proof load	Green Pin® Sling Shackles proof load	Green Pin Power Sling® Shackle proof load	Green Pin® Web Sling Shackle proof load	Green Pin BigMouth® Dee Shackle proof load
t	t	t	t	t	t	t
0.33	0.66					
0.5	1					
0.75	1.5					
1	2					
1.5	3					
2	4					
3.25	6.5				8.13	
3.3		6.6				
4.6						9.2
4.75	9.5				11.88	
5		10				
6.5	13				16.25	
7		14	14			
8.5	17				21.25	
8.6						17.2
9.5	19	19				
12	24					
12.5		25	25			
13.5	27					
15		30				
15.5						31
16	32					
17	34					
18		36	36			
21		42				
25	50					
30	60	60	60			
35	70					
40		80	80			
42.5	85					
55	110	110	110			
75	150		112.5			
85	170	170				
120	240	240				
125			187.5	250		
150	225	225	225	300		
175		262.5				
200	300		300	400		
250	375		375	500		
300	450		450	600		
400	600		532	800		
500	750		665	1000		
600	900		798	900		
700	1050		931	1050		
800	1200		1064	1200		
900	1350		1197	1350		
1000	1500		1330	1500		
1250	1875		1663	1875		
1500	2250					
1550			2061.5	2325		

Instructions for use

Select the correct type and WLL of the shackle for the particular application. If extreme circumstances or shock loading may occur, this must be taken into account when selecting the correct shackle. Please note that commercial shackles are not to be used for lifting applications.

Shackles should be inspected before use to ensure that:

- all markings are legible;
- the body and pin are both of the same brand and type;
- the body and pin are both of the correct size;
- never use a safety bolt type shackle without using a securing pin;
- the pin, nut, cotter pin, or any other locking system cannot vibrate out of position;
- the threads of the pin and the body are undamaged;
- the body and the pin are not distorted or unduly worn;
- the body and pin are free from nicks, gouges, cracks and corrosion;
- shackles may not be heat treated as this may affect their WLL;
- never modify, repair or reshape a shackle by machining, welding, heating or bending as this will affect the WLL.

Assembly

Ensure that the pin is correctly screwed into the shackle eye: tighten it hand-tight, then secure it using a wrench or other suitable tool so that the collar of the pin is fully seated against the shackle eye. Ensure that the pin is of the correct length so that it penetrates the full depth of the threaded eye and the collar of the pin touches the surface of the shackle eye.

Incorrect positioning of the pin may be caused by a bent pin, too tight fitting thread or misalignment of the pin holes. Do not use the shackle under these circumstances. Never replace a shackle pin except with one of the same brand, type, make and size to ensure the shackle maintains its original WLL.

Make sure that the shackle is supporting the load correctly, i.e. along the axis of the shackle body centerline. Avoid bending loads, unstable loads and overloads.

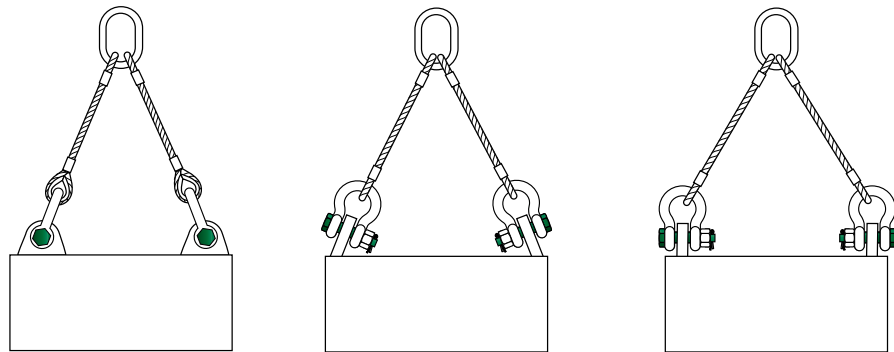

ONLY WITH REDUCED WLL

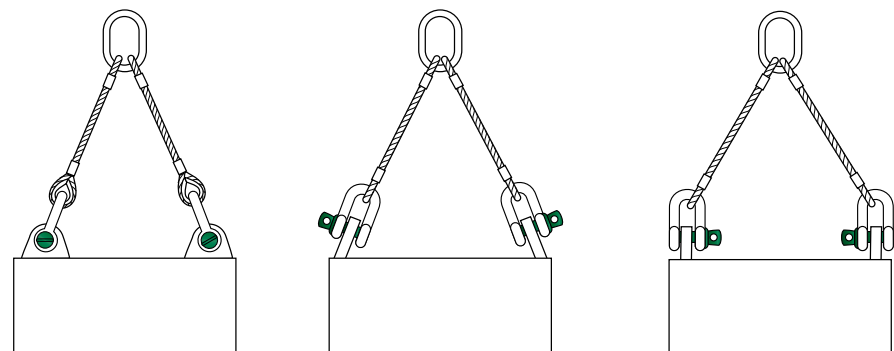

ONLY WITH REDUCED WLL

Side loads

Side loads should be avoided, as the products are not designed for this purpose. If side loads cannot be avoided, the WLL of the shackle must be reduced:

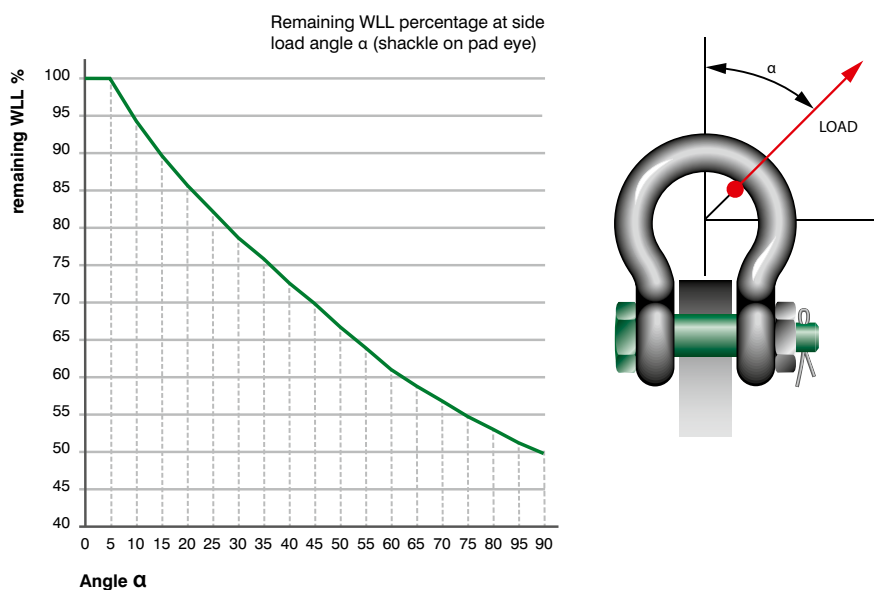

This graph is valid for almost all Green Pin® shackles, except for ROV Shackles (P-5363 and P-5367). These shackles are for in-line use only. The graph is also not valid for Green Pin® Sling Shackles (P-6033 and P-6013) and Green Pin Power Sling® Shackles (P-6043). If you want to apply a side load on a Green Pin® Sling Shackle or a Green Pin Power Sling® Shackle, please contact Van Beest.

In-line lifting is considered to be a load perpendicular to the pin and in the plane of the bow. The load angles in the graph represent the deviating angles from in-line loading.

When connecting shackles to multi-leg slings, consider the effect of the angle between the legs of the sling. As the angle increases, so does the load in the sling leg and consequently in any shackle attached to that leg.

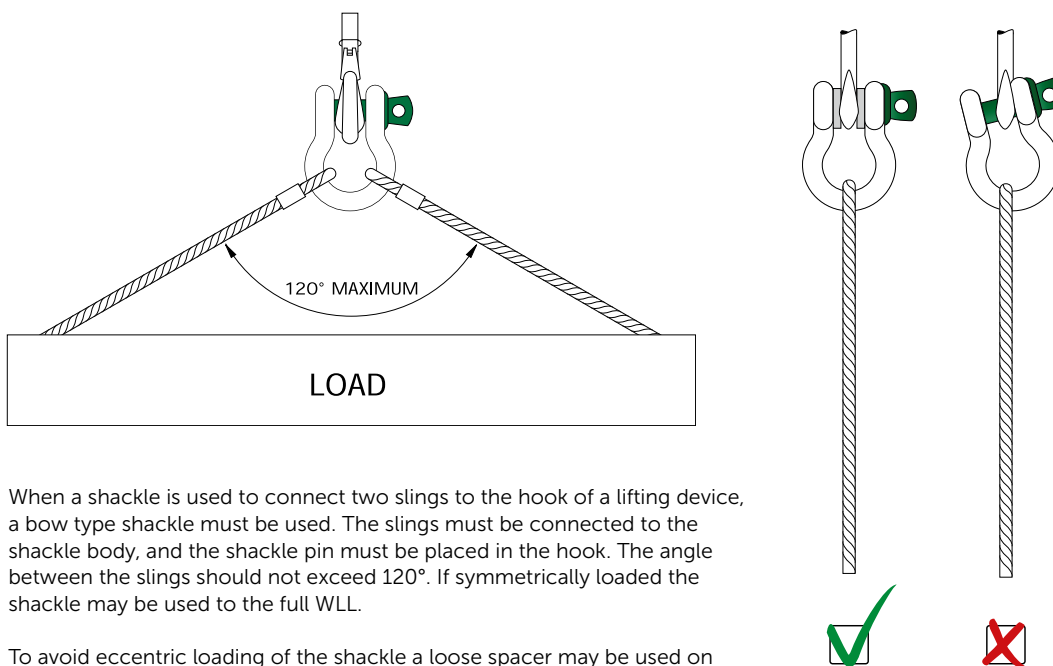

When a shackle is used to connect two slings to the hook of a lifting device, a bow type shackle must be used. The slings must be connected to the shackle body, and the shackle pin must be placed in the hook. The angle between the slings should not exceed 120°. If symmetrically loaded the shackle may be used to the full WLL.

To avoid eccentric loading of the shackle a loose spacer may be used on either end of the shackle pin. Do not reduce the width between the shackle jaws by welding washers or spacers to the inside of the shackle eyes or by narrowing the jaws, as this will affect the WLL of the shackle.

When a shackle is attached to the top block of a set of wire rope blocks the load on this shackle is increased by the value of the hoisting effect.

Avoid applications where the load moves over the shackle pin; the pin may rotate and possibly be unscrewed. If moving of the load cannot be avoided, or when the shackle is to be left in place for a prolonged period or where maximum pin security is required, use a shackle with a safety bolt, nut and cotter pin or a shackle with a fixed nut.

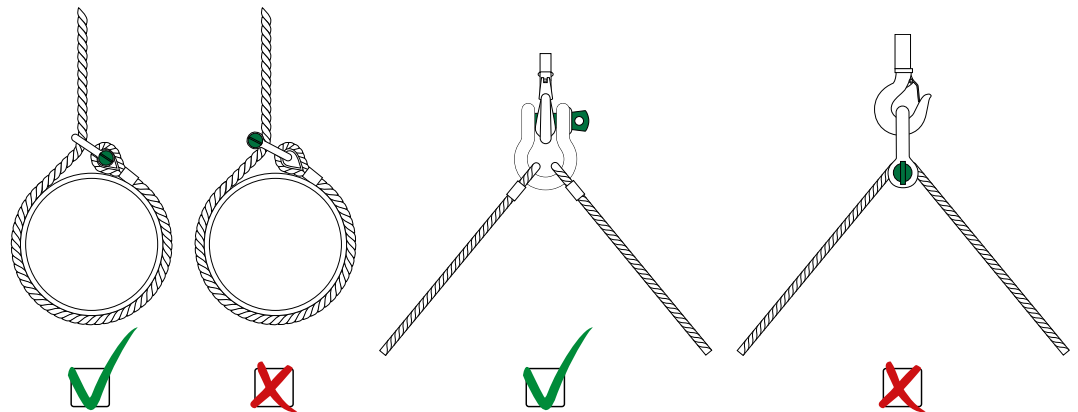

Shackles should not be immersed in acidic solutions or exposed to acidic fumes or other chemicals that are potentially harmful for the shackle.

Point loading

Shackles are used in lifting- and static systems as removable links to connect (steel) wire rope, chain and other fittings. Most of the times the load bearing component that connects to a shackle is of a rounded shape. Point loading of shackles during lifting operations is allowed but the minimum dimension of the rounded component to be lifted should be equal to or bigger than the bow size of the shackle being used. The maximum load of the configuration is limited by the component with the lowest WLL. Increasing the contact area by using bigger diameters and/or pad eyes can be an advantage. Sharp edges should be avoided. Green Pin® shackles can also be used in below configurations. The maximum load of the configuration is limited by the component with the lowest WLL.

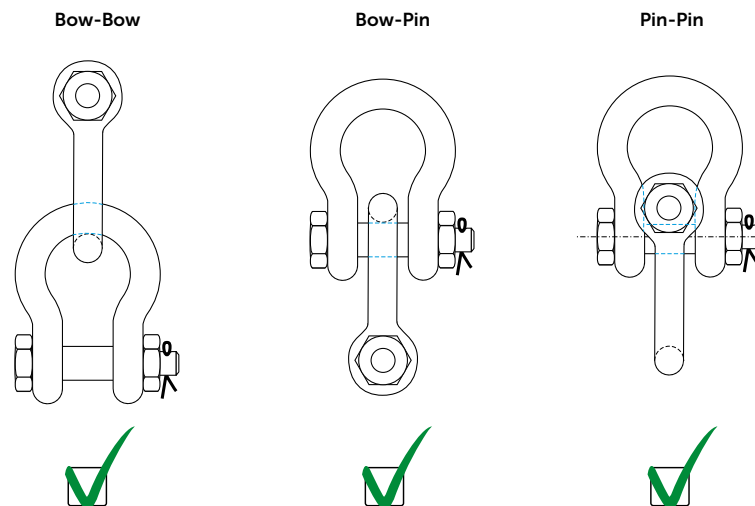

The crown of a Green Pin® Sling Shackle (P-6033) is wider than that of a standard shackle, thus creating a bigger bearing surface. This improves the lifetime of the sling. Green Pin® Sling shackles can also be used in below configurations. The maximum load of the configuration is limited by the component with the lowest WLL. For information about point loading of the Green Pin Power Sling® Shackle (P-6043) please contact sales@vanbeest.nl.

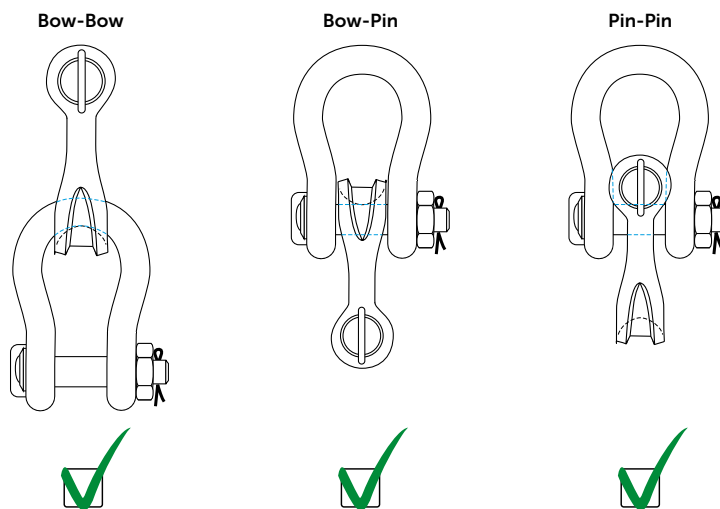

Pin- Pin configuration

When the shackle eyes touch and the pins do not bear properly, the configuration should not be used.

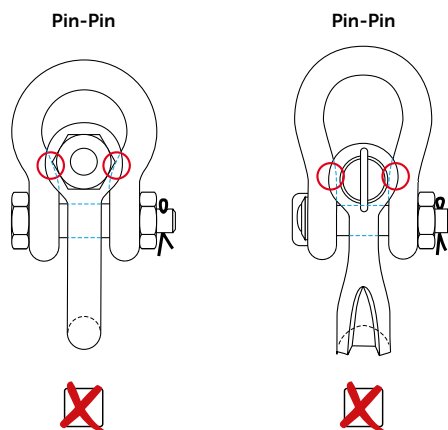

Bow- Pin configuration

When the shackle body of the inner shackle touches the shackle eyes of the outer shackle and body and pin do not bear properly, the configuration should not be used.

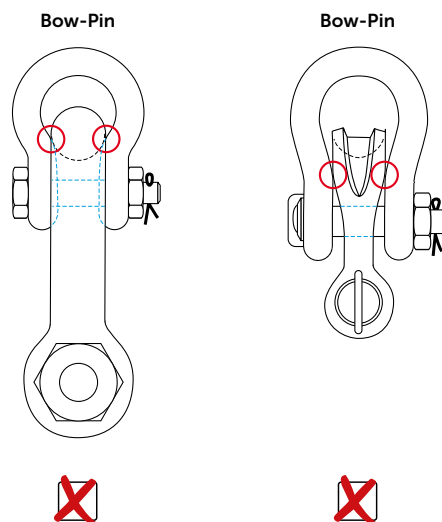

Temperature

If extreme temperature situations occur, the following load reductions must be taken into account:

Temperature	Reduction for elevated temperatures New Working Load Limit
up to 200°C	100% of original Working Load Limit
200 - 300°C	90% of original Working Load Limit
300 - 400°C	75% of original Working Load Limit
> 400°C	not allowed

The rating of shackles to EN 13889 assumes the absence of exceptionally hazardous conditions. Exceptionally hazardous conditions include offshore activities, the lifting of persons and the lifting of potentially dangerous loads such as molten metals, corrosive materials or fissile materials. In such cases a competent person should assess the degree of hazard and the WLL should be reduced accordingly.

Inspection

Shackles must be regularly inspected in accordance with the safety standards given in the country of use. This is required because the products in use may be affected by wear, misuse, overloading etc. which may lead to deformation and alteration of the material structure. Inspection should take place at least every six months and more frequently when the shackles are used in severe operating conditions.

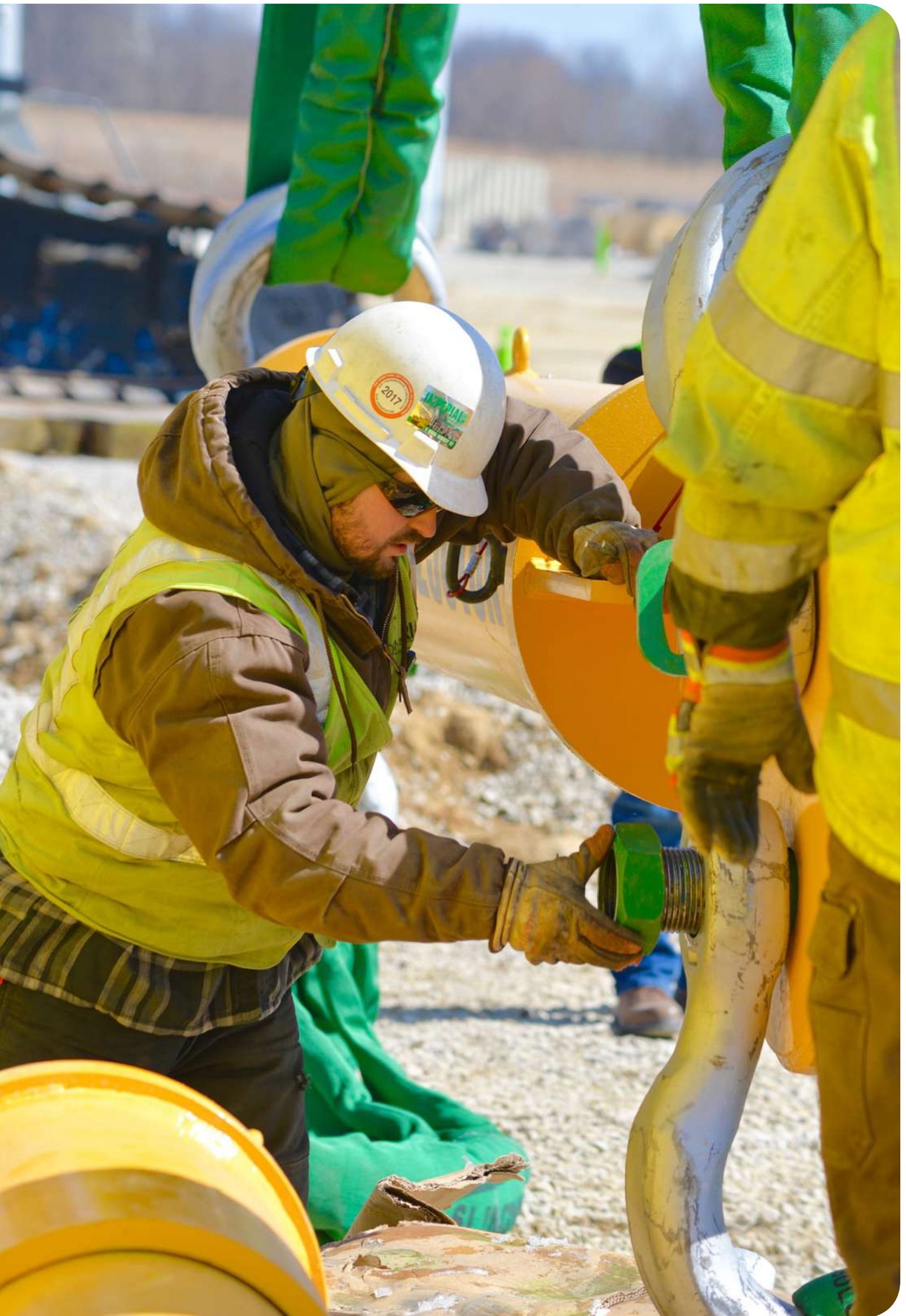



Green Pin® Bow Shackle SC

Standard bow shackle with screw collar pin



G-4161

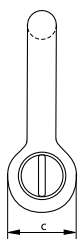
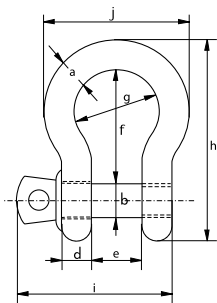

- **Material:** bow and pin high tensile steel, grade 6, quenched and tempered
- **Safety Factor:** MBL equals 6 x WLL
- **Standard:** EN 13889 and meets performance requirements of US Fed. Spec. RR-C-271 Type IVA Class 2, grade A, from 2 t and upward these shackles comply with ASME B30.26
- **Finish:** hot dipped galvanized
- **Temperature Range:** -40°C up to +200°C
- **Certification:** 2.1 2.2 3.1 MTC[®] DNV GL 0378 CE ABS PDA ABS MA

working load limit	diameter bow	diameter pin	diameter eye	width eye	width inside	length inside	width bow	length	length bolt	width	weight each
t	a mm	b mm	c mm	d mm	e mm	f mm	g mm	h mm	i mm	j mm	kg
0.33	5	6	12	5	9.5	22	16	36	29.5	26	0.02
0.5	7	8	16.5	7	12	29	20	48.5	38	34	0.05
0.75	9	10	20	9	13.5	32	22	56	46.5	40	0.1
1	10	11	22.5	10	17	36.5	26	63.5	54	46	0.14
1.5	11	13	26.5	11	19	43	29	74	59.5	51	0.19
2	13.5	16	34	13	22	51	32	89	73	58	0.36
3.25	16	19	40	16	27	64	43	110	89	75	0.63
4.75	19	22	46	19	31	76	51	129	103	89	1.01
6.5	22	25	52	22	36	83	58	144	119	102	1.5
8.5	25	28	59	25	43	95	68	164	137	118	2.21
9.5	28	32	66	28	47	108	75	185	153	131	3.16
12	32	35	72	32	51	115	83	201	170	147	4.31
13.5	35	38	80	35	57	133	92	227	186	162	5.55
17	38	42	88	38	60	146	99	249	203	175	7.43
25	45	50	103	45	74	178	126	300	243	216	12.84
35	50	57	111	50	83	197	138	331	272	238	18.15
42.5	57	65	130	57	95	222	160	377	310	274	26.29
55	65	70	145	65	105	260	180	433	344	310	37.6

In inch

working load limit	diameter bow	diameter pin	diameter eye	width eye	width inside	length inside	width bow	length	length bolt	width	weight each
t	a inch	b inch	c inch	d inch	e inch	f inch	g inch	h inch	i inch	j inch	lbs
0.33	3/16	1/4	1/2	3/16	3/8	7/8	5/8	1 13/32	1 5/32	1 1/32	0.05
0.5	1/4	5/16	21/32	9/32	15/32	1 5/32	25/32	1 29/32	1 1/2	1 11/32	0.11
0.75	5/16	3/8	25/32	11/32	17/32	1 1/4	7/8	2 7/32	1 27/32	1 9/16	0.22
1	3/8	7/16	7/8	13/32	21/32	1 7/16	1 1/32	2 1/2	2 1/8	1 13/16	0.3
1.5	7/16	1/2	11/32	7/16	3/4	1 11/16	1 5/32	2 29/32	2 11/32	2	0.42
2	1/2	5/8	1 11/32	1/2	7/8	2	1 1/4	3 1/2	2 7/8	2 9/32	0.79
3.25	5/8	3/4	1 9/16	5/8	1 1/16	2 17/32	1 11/16	4 11/32	3 1/2	2 15/16	1.38
4.75	3/4	7/8	1 13/16	3/4	1 7/32	3	2	5 3/32	4 1/16	3 1/2	2.22
6.5	7/8	1	2 1/16	7/8	1 13/32	3 9/32	2 9/32	5 21/32	4 11/16	4 1/32	3.31
8.5	1	1 1/8	2 5/16	31/32	1 11/16	3 3/4	2 11/16	6 15/32	5 13/32	4 21/32	4.86
9.5	1 1/8	1 1/4	2 19/32	1 3/32	1 27/32	4 1/4	2 15/16	7 9/32	6 1/32	5 5/32	6.97
12	1 1/4	1 3/8	2 27/32	1 1/4	2	4 17/32	3 9/32	7 29/32	6 11/16	5 25/32	9.49
13.5	1 3/8	1 1/2	3 5/32	1 3/8	2 1/4	5 1/4	3 5/8	8 15/16	7 5/16	6 3/8	12.24
17	1 1/2	1 5/8	3 15/32	1 1/2	2 3/8	5 3/4	3 29/32	9 13/16	8	6 7/8	16.37
25	1 3/4	2	4 1/16	1 25/32	2 29/32	7	4 31/32	11 13/16	9 9/16	8 1/2	28.31
35	2	2 1/4	4 3/8	1 31/32	3 9/32	7 3/4	5 7/16	13 1/32	10 23/32	9 3/8	40.01
42.5	2 1/4	2 9/16	5 1/8	2 1/4	3 3/4	8 3/4	6 5/16	14 27/32	12 7/32	10 25/32	57.96
55	2 1/2	2 3/4	5 23/32	2 9/16	4 1/8	10 1/4	7 3/32	17 1/16	13 17/32	12 7/32	82.89



CAD RFID



Green Pin® Bow Shackle BN

Standard bow shackle with safety bolt

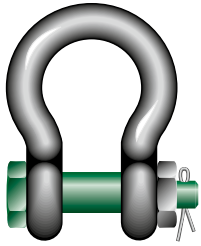

G-4163

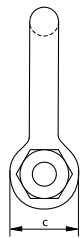
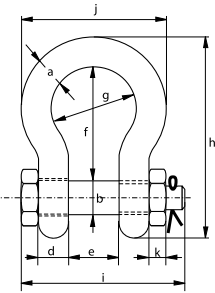

- Material:** bow and pin high tensile steel, grade 6, quenched and tempered
- Safety Factor:** MBL equals 6 x WLL
- Standard:** EN 13889 and meets performance requirements of US Fed. Spec. RR-C-271 Type IVA Class 3, grade A, from 2 t and upward these shackles comply with ASME B30.26 hot dipped galvanized
- Finish:** hot dipped galvanized
- Temperature Range:** -40°C up to +200°C
- Certification:** 2.1 2.2 3.1 MTC³ DNV GL 2.7-1³ * DNV GL 2.7-1³ * DNV GL 0378 CE ABS PDA ABS MA

working load limit	diameter bow	diameter pin	diameter eye	width eye	width inside	length inside	width bow	length	length bolt	width	thickness nut	weight each
t	a mm	b mm	c mm	d mm	e mm	f mm	g mm	h mm	i mm	j mm	k mm	kg
0.5	7	8	16.5	7	12	29	20	48.5	42	34	4	0.06
0.75	9	10	20	9	13.5	32	22	56	50	40	5	0.11
1	10	11	22.5	10	17	36.5	26	63.5	60	46	8	0.16
1.5	11	13	26.5	11	19	43	29	74	67	51	11	0.22
2	13.5	16	34	13	22	51	32	89	82	58	13	0.42
3.25	16	19	40	16	27	64	43	110	98	75	17	0.74
4.75	19	22	46	19	31	76	51	129	114	89	19	1.18
6.5	22	25	52	22	36	83	58	144	130	102	22	1.77
8.5	25	28	59	25	43	95	68	164	150	118	25	2.58
9.5	28	32	66	28	47	108	75	185	166	131	27	3.66
12	32	35	72	32	51	115	83	201	178	147	30	4.91
13.5	35	38	80	35	57	133	92	227	197	162	33	6.54
17	38	42	88	38	60	146	99	249	202	175	19	8.19
25	45	50	103	45	74	178	126	300	249	216	23	14.22
35	50	57	111	50	83	197	138	331	269	238	26	19.53
42.5	57	65	130	57	95	222	160	377	301	274	29	28.33
55	65	70	145	65	105	260	180	433	330	310	32	39.59
85	75	83	162	73	127	329	190	527	380	340	39	62

In inch

working load limit	diameter bow	diameter pin	diameter eye	width eye	width inside	length inside	width bow	length	length bolt	width	thickness nut	weight each
t	a inch	b inch	c inch	d inch	e inch	f inch	g inch	h inch	i inch	j inch	k inch	lbs
0.5	1/4	5/16	21/32	9/32	15/32	1 5/32	25/32	1 29/32	1 21/32	1 11/32	5/32	0.13
0.75	5/16	3/8	25/32	11/32	17/32	1 1/4	7/8	2 7/32	1 31/32	1 9/16	3/16	0.25
1	3/8	7/16	7/8	13/32	21/32	1 7/16	1 1/32	2 1/2	2 3/8	1 13/16	5/16	0.34
1.5	7/16	1/2	1 1/32	7/16	3/4	1 11/16	1 5/32	2 29/32	2 5/8	2	7/16	0.48
2	1/2	5/8	1 11/32	1/2	7/8	2	1 1/4	3 1/2	3 7/32	2 9/32	1/2	0.92
3.25	5/8	3/4	1 9/16	5/8	1 1/16	2 17/32	1 11/16	4 11/32	3 27/32	2 15/16	21/32	1.62
4.75	3/4	7/8	1 13/16	3/4	1 7/32	3	2	5 3/32	4 1/2	3 1/2	3/4	2.59
6.5	7/8	1	2 1/16	7/8	1 13/32	3 9/32	2 9/32	5 21/32	5 1/8	4 1/32	7/8	3.9
8.5	1	1 1/8	2 5/16	31/32	1 11/16	3 3/4	2 11/16	6 15/32	5 29/32	4 21/32	31/32	5.69
9.5	1 1/8	1 1/4	2 19/32	1 3/32	1 27/32	4 1/4	2 15/16	7 9/32	6 17/32	5 5/32	1 1/16	8.06
12	1 1/4	1 3/8	2 27/32	1 1/4	2	4 17/32	3 9/32	7 29/32	7	5 25/32	1 3/16	10.81
13.5	1 3/8	1 1/2	3 5/32	1 3/8	2 1/4	5 1/4	3 5/8	8 15/16	7 3/4	6 3/8	1 5/16	14.42
17	1 1/2	1 5/8	3 15/32	1 1/2	2 3/8	5 3/4	3 29/32	9 13/16	7 15/16	6 7/8	3/4	18.06
25	1 3/4	2	4 1/16	1 25/32	2 29/32	7	4 31/32	11 13/16	9 13/16	8 1/2	29/32	31.34
35	2	2 1/4	4 3/8	1 31/32	3 9/32	7 3/4	5 7/16	13 1/32	10 19/32	9 3/8	1 1/32	43.77
42.5	2 1/4	2 9/16	5 1/8	2 1/4	3 3/4	8 3/4	6 5/16	14 27/32	11 27/32	10 23/32	1 5/32	62.46
55	2 1/2	2 3/4	5 23/32	2 9/16	4 1/8	10 1/4	7 3/32	17 1/16	13	12 7/32	1 1/4	87.27
85	3	3 1/4	6 3/8	2 7/8	5	12 15/16	7 15/32	20 3/4	14 31/32	13 3/8	1 17/32	136.69



CAD RFID

* For shackles ≥ WLL 2 t



Green Pin® Bow Shackle FN

Standard bow shackle with safety bolt and fixed nut

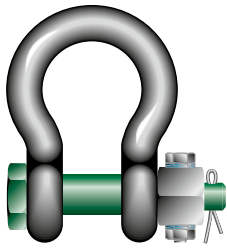

G-4143

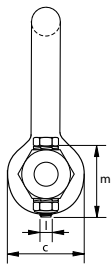
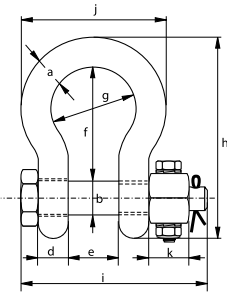

- **Material:** bow and pin high tensile steel, grade 6, quenched and tempered
- **Safety Factor:** MBL equals 6 x WLL
- **Standard:** EN 13889 and meets performance requirements of US Fed. Spec. RR-C-271 Type IVA Class 3, grade A, from 2 t and upward these shackles comply with ASME B30.26
- **Finish:** hot dipped galvanized
- **Temperature Range:** -40°C up to +200°C
- **Certification:** 2.1 2.2 3.1 MTC[®] DNV GL 2.7-1[®] DNV GL 2.7-1[®] CE

working load limit	diameter bow	diameter pin	diameter eye	width eye	width inside	length inside	width bow	length bow	length bolt	width bow	thickness nut	securing bolt thread	securing bolt length	torque	weight each
t	a mm	b mm	c mm	d mm	e mm	f mm	g mm	h mm	i mm	j mm	k mm	l mm	m mm	Nm	kg
2	13.5	16	34	13	22	51	32	89	82	58	13	M6	35	8.4	0.42
3.25	16	19	40	16	27	64	43	110	98	75	17	M6	40	8.4	0.74
4.75	19	22	46	19	31	76	51	129	114	89	19	M6	45	8.4	1.18
6.5	22	25	52	22	36	83	58	144	130	102	22	M8	50	20	1.77
8.5	25	28	59	25	43	95	68	164	150	118	25	M8	55	20	2.58
9.5	28	32	66	28	47	108	75	185	166	131	27	M10	60	39	3.66
12	32	35	72	32	51	115	83	201	178	147	30	M10	65	39	4.91
13.5	35	38	80	35	57	133	92	227	197	162	33	M10	70	39	6.54
17	38	42	88	38	60	146	99	249	202	175	19	M8	75	20	8.19
25	45	50	103	45	74	178	126	300	249	216	23	M8	90	20	14.22
35	50	57	111	50	83	197	138	331	269	238	26	M10	100	39	19.85
42.5	57	65	130	57	95	222	160	377	301	274	29	M12	110	68	28.33
55	65	70	145	65	105	260	180	433	330	310	32	M12	120	68	39.59
85	75	83	162	73	127	329	190	527	380	340	39	M12	140	68	62

In inch

working load limit	diameter bow	diameter pin	diameter eye	width eye	width inside	length inside	width bow	length bow	length bolt	width bow	thickness nut	securing bolt thread	securing bolt length	torque	weight each
t	a inch	b inch	c inch	d inch	e inch	f inch	g inch	h inch	i inch	j inch	k inch	l mm	m inch	ft lb	lbs
2	1/2	5/8	1 11/32	1/2	7/8	2	1 1/4	3 1/2	3 7/32	2 9/32	1/2	M6	1 3/8	6.2	0.92
3.25	5/8	3/4	1 9/16	5/8	1 1/16	2 17/32	1 11/16	4 11/32	3 27/32	2 15/16	21/32	M6	1 9/16	6.2	1.62
4.75	3/4	7/8	1 13/16	3/4	1 7/32	3	2	5 3/32	4 1/2	3 1/2	3/4	M6	1 25/32	6.2	2.59
6.5	7/8	1	2 1/16	7/8	1 13/32	3 9/32	2 9/32	5 21/32	5 1/8	4 1/32	7/8	M8	1 31/32	14.7	3.9
8.5	1	1 1/8	2 5/16	31/32	1 11/16	3 3/4	2 11/16	6 15/32	5 29/32	4 21/32	31/32	M8	2 5/32	14.7	5.69
9.5	1 1/8	1 1/4	2 19/32	1 3/32	1 27/32	4 1/4	2 15/16	7 9/32	6 17/32	5 5/32	1 1/16	M10	2 3/8	28.7	8.06
12	1 1/4	1 3/8	2 27/32	1 1/4	2	4 17/32	3 9/32	7 29/32	7	5 25/32	1 3/16	M10	2 9/16	28.7	10.81
13.5	1 3/8	1 1/2	3 5/32	1 3/8	2 1/4	5 1/4	3 5/8	8 15/16	7 3/4	6 3/8	1 5/16	M10	2 3/4	28.7	14.42
17	1 1/2	1 5/8	3 15/32	1 1/2	2 3/8	5 3/4	3 29/32	9 13/16	7 15/16	6 7/8	3/4	M8	2 15/16	14.7	18.06
25	1 3/4	2	4 1/16	1 25/32	2 29/32	7	4 31/32	11 13/16	9 13/16	8 1/2	29/32	M8	3 17/32	14.7	31.34
35	2	2 1/4	4 3/8	1 31/32	3 9/32	7 3/4	5 7/16	13 1/32	10 19/32	9 3/8	1 1/32	M10	3 15/16	28.7	43.77
42.5	2 1/4	2 9/16	5 1/8	2 1/4	3 3/4	8 3/4	6 5/16	14 27/32	11 27/32	10 23/32	1 5/32	M12	4 11/32	50.1	62.46
55	2 1/2	2 3/4	5 23/32	2 9/16	4 1/8	10 1/4	7 3/32	17 1/16	13	12 7/32	1 1/4	M12	4 23/32	50.1	87.27
85	3	3 1/4	6 3/8	2 7/8	5	12 15/16	7 15/32	20 3/4	14 31/32	13 3/8	1 17/32	M12	5 1/2	50.1	136.69





Green Pin® Dee Shackle SC

Standard dee shackle with screw collar pin



G-4151

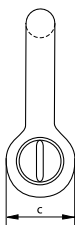
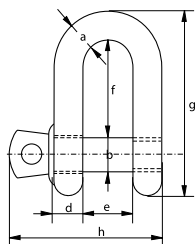

- **Material:** bow and pin high tensile steel, grade 6, quenched and tempered
- **Safety Factor:** MBL equals 6 x WLL
- **Standard:** EN13889 and meets performance requirements of US Fed. Spec. RR-C-271 Type IVB Class 3, grade A, from 2 t upward these shackles comply with ASME B30.26
- **Finish:** hot dipped galvanized
- **Temperature Range:** -40°C up to +200°C
- **Certification:** 2.1 2.2 3.1 MTC[®] DNV GL 0378 CE ABS PDA ABS MA

working load limit	diameter bow	diameter pin	diameter eye	width eye	width inside	length inside	length	length bolt	weight each
t	a mm	b mm	c mm	d mm	e mm	f mm	g mm	h mm	kg
0.33	5	6	12	5	9.5	19	33	29.5	0.02
0.5	7	8	16.5	7	12	22	41.5	38	0.05
0.75	9	10	20	9	13.5	26	50	46.5	0.09
1	10	11	22.5	10	17	32	59	54	0.14
1.5	11	13	26.5	11	19	37	68	59.5	0.19
2	13.5	16	34	13	22	43	81	73	0.32
3.25	16	19	40	16	27	51	97	89	0.54
4.75	19	22	46	19	31	59	112	103	0.87
6.5	22	25	52	22	36	73	134	119	1.34
8.5	25	28	59	25	43	85	154	137	2.08
9.5	28	32	66	28	47	90	167	153	2.77
12	32	35	72	32	51	94	180	170	3.72
13.5	35	38	80	35	57	115	209	186	5.14
17	38	42	88	38	60	127	230	203	6.85
25	45	50	103	45	74	149	271	243	11.45
35	50	57	111	50	83	171	305	272	16.86
42.5	57	65	130	57	95	190	345	310	24.61
55	65	70	145	65	105	203	376	344	32.65

In inch

working load limit	diameter bow	diameter pin	diameter eye	width eye	width inside	length inside	length	length bolt	weight each
t	a inch	b inch	c inch	d inch	e inch	f inch	g inch	h inch	lbs
0.33	$\frac{3}{16}$	$\frac{1}{4}$	$\frac{15}{32}$	$\frac{3}{16}$	$\frac{3}{8}$	$\frac{3}{4}$	$1\frac{5}{16}$	$1\frac{5}{32}$	0.04
0.5	$\frac{1}{4}$	$\frac{5}{16}$	$\frac{21}{32}$	$\frac{9}{32}$	$\frac{15}{32}$	$\frac{7}{8}$	$1\frac{5}{8}$	$1\frac{1}{2}$	0.11
0.75	$\frac{5}{16}$	$\frac{3}{8}$	$\frac{25}{32}$	$\frac{11}{32}$	$\frac{17}{32}$	$1\frac{1}{32}$	$1\frac{31}{32}$	$1\frac{27}{32}$	0.2
1	$\frac{3}{8}$	$\frac{7}{16}$	$\frac{7}{8}$	$\frac{13}{32}$	$\frac{21}{32}$	$1\frac{1}{4}$	$2\frac{5}{16}$	$2\frac{1}{8}$	0.3
1.5	$\frac{7}{16}$	$\frac{1}{2}$	$1\frac{1}{32}$	$\frac{7}{16}$	$\frac{3}{4}$	$1\frac{15}{32}$	$2\frac{11}{16}$	$2\frac{11}{32}$	0.42
2	$\frac{1}{2}$	$\frac{5}{8}$	$1\frac{11}{32}$	$\frac{1}{2}$	$\frac{7}{8}$	$1\frac{11}{16}$	$3\frac{3}{16}$	$2\frac{7}{8}$	0.7
3.25	$\frac{5}{8}$	$\frac{3}{4}$	$1\frac{9}{16}$	$\frac{5}{8}$	$1\frac{1}{16}$	2	$3\frac{13}{16}$	$3\frac{1}{2}$	1.19
4.75	$\frac{3}{4}$	$\frac{7}{8}$	$1\frac{13}{16}$	$\frac{3}{4}$	$1\frac{7}{32}$	$2\frac{5}{16}$	$4\frac{13}{32}$	$4\frac{1}{16}$	1.92
6.5	$\frac{7}{8}$	1	$2\frac{1}{16}$	$\frac{7}{8}$	$1\frac{13}{32}$	$2\frac{7}{8}$	$5\frac{9}{32}$	$4\frac{11}{16}$	2.95
8.5	1	$1\frac{1}{8}$	$2\frac{5}{16}$	$\frac{31}{32}$	$1\frac{11}{16}$	$3\frac{11}{32}$	$6\frac{1}{16}$	$5\frac{13}{32}$	4.59
9.5	$1\frac{1}{8}$	$1\frac{1}{4}$	$2\frac{19}{32}$	$1\frac{3}{32}$	$1\frac{27}{32}$	$3\frac{17}{32}$	$6\frac{9}{16}$	$6\frac{1}{32}$	6.1
12	$1\frac{1}{4}$	$1\frac{3}{8}$	$2\frac{27}{32}$	$1\frac{1}{4}$	2	$3\frac{11}{16}$	$7\frac{3}{32}$	$6\frac{11}{16}$	8.2
13.5	$1\frac{3}{8}$	$1\frac{1}{2}$	$3\frac{5}{32}$	$1\frac{3}{8}$	$2\frac{1}{4}$	$4\frac{17}{32}$	$8\frac{7}{32}$	$7\frac{5}{16}$	11.33
17	$1\frac{1}{2}$	$1\frac{5}{8}$	$3\frac{15}{32}$	$1\frac{1}{2}$	$2\frac{3}{8}$	5	$9\frac{1}{16}$	8	15.1
25	$1\frac{3}{4}$	2	$4\frac{1}{16}$	$1\frac{25}{32}$	$2\frac{29}{32}$	$5\frac{7}{8}$	$10\frac{21}{32}$	$9\frac{9}{16}$	25.23
35	2	$2\frac{1}{4}$	$4\frac{3}{8}$	$1\frac{31}{32}$	$3\frac{9}{32}$	$6\frac{23}{32}$	12	$10\frac{23}{32}$	37.17
42.5	$2\frac{1}{4}$	$2\frac{9}{16}$	$5\frac{1}{8}$	$2\frac{1}{4}$	$3\frac{3}{4}$	$7\frac{15}{32}$	$13\frac{19}{32}$	$12\frac{7}{32}$	54.26
55	$2\frac{1}{2}$	$2\frac{3}{4}$	$5\frac{23}{32}$	$2\frac{9}{16}$	$4\frac{1}{8}$	8	$14\frac{13}{16}$	$13\frac{17}{32}$	71.98



CAD RFID



Green Pin® Dee Shackle BN

Standard dee shackle with safety bolt

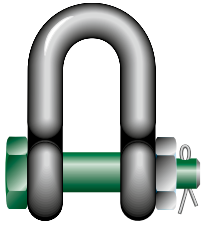

G-4153

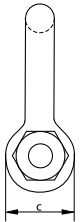
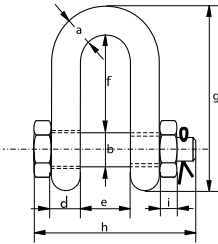

- **Material:** bow and pin high tensile steel, grade 6, quenched and tempered
- **Safety Factor:** MBL equals 6 x WLL
- **Standard:** EN 13889, ASME B30.26 and meets performance requirements of US Fed. Spec. RR-C-271 Type IVB Class 3, grade A
- **Finish:** hot dipped galvanized
- **Temperature Range:** -40°C up to +200°C
- **Certification:** 2.1 2.2 3.1 MTC⁹ DNV GL 2.7-1⁹ * DNV GL 2.7-1⁹ * DNV GL 0378 CE ABS PDA ABS MA

working load limit	diameter bow	diameter pin	diameter eye	width eye	width inside	length inside	length	length bolt	thickness nut	weight each
t	a mm	b mm	c mm	d mm	e mm	f mm	g mm	h mm	i mm	kg
2	13.5	16	34	13	22	43	81	82	13	0.39
3.25	16	19	40	16	27	51	97	98	17	0.67
4.75	19	22	46	19	31	59	112	114	19	1.08
6.5	22	25	52	22	36	73	134	130	22	1.66
8.5	25	28	59	25	43	85	154	150	25	2.46
9.5	28	32	66	28	47	90	167	166	27	3.4
12	32	35	72	32	51	94	180	178	30	4.51
13.5	35	38	80	35	57	115	209	197	33	6.1
17	38	42	88	38	60	127	230	202	19	7.63
25	45	50	103	45	74	149	271	249	23	12.88
35	50	57	111	50	83	171	305	269	26	17.35
42.5	57	65	130	57	95	190	345	301	29	25.94
55	65	70	145	65	105	203	376	330	32	35.33
85	75	83	162	73	127	229	427	380	39	52.97

In inch

working load limit	diameter bow	diameter pin	diameter eye	width eye	width inside	length inside	length	length bolt	thickness nut	weight each
t	a inch	b inch	c inch	d inch	e inch	f inch	g inch	h inch	i inch	lbs
2	1/2	5/8	1 11/32	1/2	7/8	1 11/16	3 3/16	3 7/32	1/2	0.85
3.25	5/8	3/4	1 9/16	5/8	1 1/16	2	3 13/16	3 27/32	21/32	1.48
4.75	3/4	7/8	1 13/16	3/4	1 7/32	2 5/16	4 13/32	4 1/2	3/4	2.39
6.5	7/8	1	2 1/16	7/8	1 13/32	2 7/8	5 9/32	5 1/8	7/8	3.66
8.5	1	1 1/8	2 5/16	31/32	1 11/16	3 11/32	6 1/16	5 29/32	31/32	5.42
9.5	1 1/8	1 1/4	2 19/32	1 3/32	1 27/32	3 17/32	6 9/16	6 17/32	1 1/16	7.5
12	1 1/4	1 3/8	2 27/32	1 1/4	2	3 11/16	7 3/32	7	1 3/16	9.95
13.5	1 3/8	1 1/2	3 5/32	1 3/8	2 1/4	4 17/32	8 7/32	7 3/4	1 5/16	13.45
17	1 1/2	1 5/8	3 15/32	1 1/2	2 3/8	5	9 1/16	7 15/16	3/4	16.82
25	1 3/4	2	4 1/16	1 25/32	2 29/32	5 7/8	10 21/32	9 13/16	29/32	28.4
35	2	2 1/4	4 3/8	1 31/32	3 9/32	6 23/32	12	10 19/32	1 1/32	38.25
42.5	2 1/4	2 9/16	5 1/8	2 1/4	3 3/4	7 15/32	13 19/32	11 27/32	1 5/32	57.19
55	2 1/2	2 3/4	5 23/32	2 9/16	4 1/8	8	14 13/16	13	1 1/4	77.89
85	3	3 1/4	6 3/8	2 7/8	5	9 1/32	16 13/16	14 31/32	1 17/32	116.77

CAD RFID



* For shackles ≥ WLL 2 t



Green Pin® Dee Shackle FN

Standard dee shackle with safety bolt and fixed nut

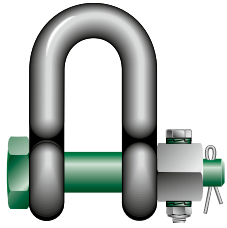

G-4133

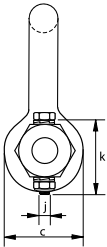
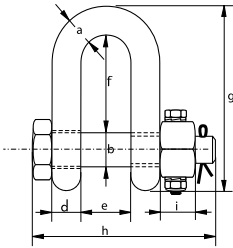

- **Material:** bow and pin high tensile steel, grade 6, quenched and tempered
- **Safety Factor:** MBL equals 6 x WLL
- **Standard:** EN 13889, ASME B30.26 and meets performance requirements of US Fed. Spec. RR-C-271 Type IVB Class 3, grade A
- **Finish:** hot dipped galvanized
- **Temperature Range:** -40°C up to +200°C
- **Certification:** 2.1 2.2 3.1 MTC³ DNV GL 2.7-1³ DNV GL 2.7-1³ CE

working load limit	diameter bow	diameter pin	diameter eye	width eye	width inside	length inside	length	length bolt	thickness nut	securing bolt thread	securing bolt length	torque	weight each
t	a mm	b mm	c mm	d mm	e mm	f mm	g mm	h mm	i mm	j mm	k mm	Nm	kg
2	13.5	16	34	13	22	43	81	82	13	M6	35	8.4	0.39
3.25	16	19	40	16	27	51	97	98	17	M6	40	8.4	0.67
4.75	19	22	46	19	31	59	112	114	19	M6	45	8.4	1.08
6.5	22	25	52	22	36	73	134	130	22	M8	50	20	1.66
8.5	25	28	59	25	43	85	154	150	25	M8	55	20	2.46
9.5	28	32	66	28	47	90	167	166	27	M10	60	39	3.4
12	32	35	72	32	51	94	180	178	30	M10	65	39	4.51
13.5	35	38	80	35	57	115	209	197	33	M10	70	39	6.1
17	38	42	88	38	60	127	230	202	19	M8	75	20	7.63
25	45	50	103	45	74	149	271	249	23	M8	90	20	13.25
35	50	57	111	50	83	171	305	269	26	M10	100	39	18.53
42.5	57	65	130	57	95	190	345	301	29	M12	110	68	25.94
55	65	70	145	65	105	203	376	330	32	M12	120	68	35.33
85	75	83	162	73	127	229	427	380	39	M12	140	68	52.97

In inch

working load limit	diameter bow	diameter pin	diameter eye	width eye	width inside	length inside	length	length bolt	thickness nut	securing bolt thread	securing bolt length	torque	weight each
t	a inch	b inch	c inch	d inch	e inch	f inch	g inch	h inch	i inch	j mm	k inch	ft lb	lbs
2	1/2	5/8	1 11/32	1/2	7/8	1 11/16	3 3/16	3 7/32	1/2	M6	1 3/8	6.2	0.85
3.25	5/8	3/4	1 9/16	5/8	1 1/16	2	3 13/16	3 27/32	21/32	M6	1 9/16	6.2	1.48
4.75	3/4	7/8	1 13/16	3/4	1 7/32	2 5/16	4 13/32	4 1/2	3/4	M6	1 25/32	6.2	2.39
6.5	7/8	1	2 1/16	7/8	1 13/32	2 7/8	5 9/32	5 1/8	7/8	M8	1 31/32	14.7	3.66
8.5	1	1 1/8	2 5/16	31/32	1 11/16	3 11/32	6 1/16	5 29/32	31/32	M8	2 5/32	14.7	5.42
9.5	1 1/8	1 1/4	2 19/32	1 3/32	1 27/32	3 17/32	6 9/16	6 17/32	1 1/16	M10	2 3/8	28.7	7.5
12	1 1/4	1 3/8	2 27/32	1 1/4	2	3 11/16	7 3/32	7	1 3/16	M10	2 9/16	28.7	9.95
13.5	1 3/8	1 1/2	3 5/32	1 3/8	2 1/4	4 17/32	8 7/32	7 3/4	1 5/16	M10	2 3/4	28.7	13.45
17	1 1/2	1 5/8	3 15/32	1 1/2	2 3/8	5	9 1/16	7 15/16	3/4	M8	2 15/16	14.7	16.82
25	1 3/4	2	4 1/16	1 25/32	2 29/32	5 7/8	10 21/32	9 13/16	29/32	M8	3 17/32	14.7	29.21
35	2	2 1/4	4 3/8	1 31/32	3 9/32	6 23/32	12	10 19/32	1 1/32	M10	3 15/16	28.7	40.86
42.5	2 1/4	2 9/16	5 1/8	2 1/4	3 3/4	7 15/32	13 19/32	11 27/32	1 5/32	M12	4 11/32	50.1	57.19
55	2 1/2	2 3/4	5 23/32	2 9/16	4 1/8	8	14 13/16	13	1 1/4	M12	4 23/32	50.1	77.89
85	3	3 1/4	6 3/8	2 7/8	5	9 1/32	16 13/16	14 31/32	1 17/32	M12	5 1/2	50.1	116.77





Green Pin® Heavy Duty Bow Shackle BN

High load capacity bow shackle with safety bolt

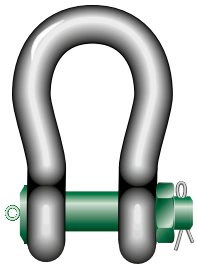

P-6036

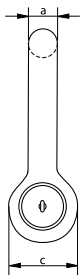
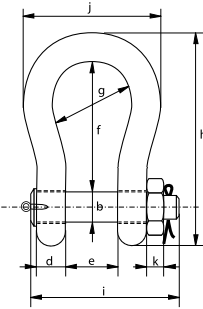

- **Material:** bow and pin alloy steel, grade 8 quenched and tempered
- **Safety Factor:** MBL equals 5 x WLL
- **Standard:** ASME B30.26
- **Finish:** shackle bow painted silver, pin painted green (120 tons shackle is hot dipped galvanized)
- **Certification:** 2.1 2.2 3.1 MTC^a MTC^b * LROS * MPI^a US^a CE

working load limit	diameter bow	diameter pin	diameter eye	width eye	width inside	length inside	width bow	length	length bolt	width	thickness nut	weight each
t	a mm	b mm	c mm	d mm	e mm	f mm	g mm	h mm	i mm	j mm	k mm	kg
120	95	95	208	95	147	400	238	647	453	428	50	110
150	105	108	238	105	169	410	275	688	496	485	50	160
200	120	130	279	120	179	513	290	838	564	530	70	235
250	130	140	299	130	205	554	305	904	614	565	70	295
300	140	150	325	140	205	618	305	996	644	585	80	368
400	170	175	376	164	231	668	325	1114	690	665	70	560
500	180	185	398	164	256	718	350	1190	720	710	70	685
600	200	205	444	189	282	718	375	1243	810	775	70	880
700	210	215	454	204	308	718	400	1263	870	820	70	980
800	210	220	464	204	308	718	400	1270	870	820	70	1100
900	220	230	485	215	328	718	420	1296	920	860	70	1280
1000	240	240	515	215	349	718	420	1336	940	900	70	1460
1250	260	270	585	230	369	768	450	1456	1025	970	70	1990
1500	280	290	625	230	369	818	450	1556	1025	1010	70	2400

In inch

working load limit	diameter bow	diameter pin	diameter eye	width eye	width inside	length inside	width bow	length	length bolt	width	thickness nut	weight each
t	a inch	b inch	c inch	d inch	e inch	f inch	g inch	h inch	i inch	j inch	k inch	lbs
120	3 3/4	3 3/4	8 3/16	3 3/4	5 25/32	15 3/4	9 3/8	25 15/32	17 27/32	16 27/32	1 31/32	243
150	4 1/8	4 1/4	9 3/8	4 1/8	6 21/32	16 5/32	10 13/16	27 3/32	19 17/32	19 3/32	1 31/32	353
200	4 23/32	5 1/8	10 31/32	4 23/32	7 1/16	20 3/16	11 13/32	33	22 3/16	20 7/8	2 3/4	518
250	5 1/8	5 1/2	11 25/32	5 1/8	8 1/16	21 13/16	12	35 19/32	24 5/32	22 1/4	2 3/4	650
300	5 1/2	5 29/32	12 25/32	5 1/2	8 1/16	24 11/32	12	39 7/32	25 11/32	23 1/32	3 5/32	811
400	6 11/16	6 7/8	14 13/16	6 15/32	9 3/32	26 5/16	12 25/32	43 27/32	27 5/32	26 3/16	2 3/4	1235
500	7 3/32	7 9/32	15 21/32	6 15/32	10 3/32	28 9/32	13 25/32	46 27/32	28 11/32	27 15/16	2 3/4	1510
600	7 7/8	8 1/16	17 15/32	7 7/16	11 3/32	28 9/32	14 3/4	48 15/16	31 7/8	30 1/2	2 3/4	1940
700	8 9/32	8 15/32	17 7/8	8 1/32	12 1/8	28 9/32	15 3/4	49 23/32	34 1/4	32 9/32	2 3/4	2161
800	8 9/32	8 21/32	18 9/32	8 1/32	12 1/8	28 9/32	15 3/4	50	34 1/4	32 9/32	2 3/4	2425
900	8 21/32	9 1/16	19 3/32	8 15/32	12 29/32	28 9/32	16 17/32	51 1/32	36 7/32	33 27/32	2 3/4	2822
1000	9 7/16	9 7/16	20 9/32	8 15/32	13 3/4	28 9/32	16 17/32	52 19/32	37	35 7/16	2 3/4	3219
1250	10 1/4	10 5/8	23 1/32	9 1/16	14 17/32	30 1/4	17 23/32	57 5/16	40 11/32	38 3/16	2 3/4	4387
1500	11 1/32	11 13/32	24 19/32	9 1/16	14 17/32	32 7/32	17 23/32	61 1/4	40 11/32	39 3/4	2 3/4	5291

CAD RFID

* For shackles ≥ WLL 150 t



Green Pin® Heavy Duty Bow Shackle FN

High load capacity bow shackle with safety bolt and fixed nut

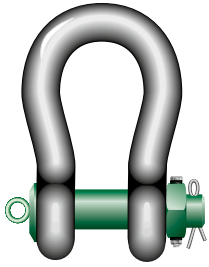

P-6016

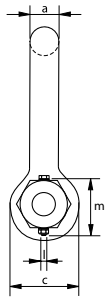
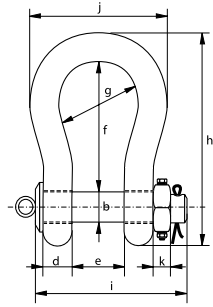

- **Material:** bow and pin alloy steel, grade 8, quenched and tempered
- **Safety Factor:** MBL equals 5 x WLL
- **Standard:** ASME B30.26
- **Finish:** shackle bow painted silver, pin painted green (120 tons shackle is hot dipped galvanized)

• **Certification:** 2.1 2.2 3.1 MTC^a MTC^b * LROS * MPI^a US^a CE

working load limit	diameter bow	diameter pin	diameter eye	width eye	width inside	length inside	width bow	length	length bolt	width	thickness nut	securing bolt thread	securing bolt length	torque	weight each
t	a	b	c	d	e	f	g	h	i	j	k	l	m	Nm	kg
120	95	95	208	95	147	400	238	647	453	428	50	M12	150	68	110
150	105	108	238	105	169	410	275	688	496	485	50	M12	160	68	160

In inch

working load limit	diameter bow	diameter pin	diameter eye	width eye	width inside	length inside	width bow	length	length bolt	width	thickness nut	securing bolt thread	securing bolt length	torque	weight each
t	a	b	c	d	e	f	g	h	i	j	k	l	m	ft lb	lbs
120	3 3/4	3 3/4	8 3/16	3 3/4	5 25/32	15 3/4	9 3/8	25 15/32	17 27/32	16 27/32	1 31/32	M12	5 29/32	50.1	243
150	4 1/8	4 1/4	9 3/8	4 1/8	6 21/32	16 5/32	10 13/16	27 3/32	19 17/32	19 3/32	1 31/32	M12	6 5/16	50.1	353

* For shackles ≥ WLL 150 t



Green Pin® Heavy Duty Dee Shackle BN

High load capacity dee shackle with safety bolt

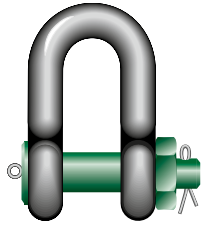

G-6038

- **Material:** bow and pin alloy steel, grade 8 quenched and tempered
- **Safety Factor:** MBL equals 5 x WLL
- **Standard:** ASME B30.26
- **Finish:** hot dipped galvanized
- **Certification:** 2.1 2.2 3.1 MTC^a MPI^a US^a CE

working load limit	diameter bow	diameter pin	diameter eye	width eye	width inside	length inside	length	length bolt	thickness nut	weight each
t	a	b	c	d	e	f	g	h	i	kg
120	95	95	208	95	147	274	521	453	50	110

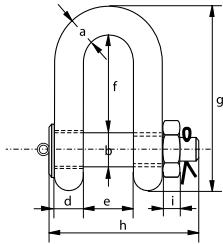

In inch

working load limit	diameter bow	diameter pin	diameter eye	width eye	width inside	length inside	length	length bolt	thickness nut	weight each
t	a	b	c	d	e	f	g	h	i	lbs
120	3 ³ / ₄	3 ³ / ₄	8 ³ / ₁₆	3 ³ / ₄	5 ²⁵ / ₃₂	10 ²⁵ / ₃₂	20 ¹ / ₂	17 ²⁷ / ₃₂	1 ³¹ / ₃₂	243



CAD RFID



Green Pin® Heavy Duty Dee Shackle FN

High load capacity dee shackle with safety bolt and fixed nut

- **Material:** bow and pin alloy steel, grade 8, quenched and tempered
- **Safety Factor:** MBL equals 5 x WLL
- **Standard:** ASME B30.26
- **Finish:** hot dipped galvanized
- **Certification:** 2.1 2.2 3.1 MTC^a MPI^a US^a CE

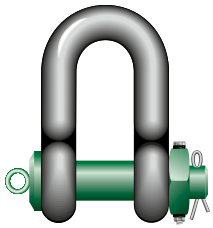

G-6018

working load limit	diameter bow	diameter pin	diameter eye	width eye	width inside	length inside	length	length bolt	thickness nut	securing bolt thread	securing bolt length	torque	weight each
t	a	b	c	d	e	f	g	h	i	j	k	Nm	kg
120	95	95	208	95	147	274	521	453	50	M12	150	68	110

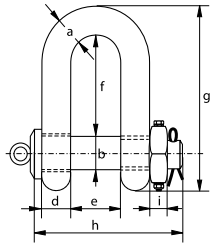

In inch

working load limit	diameter bow	diameter pin	diameter eye	width eye	width inside	length inside	length	length bolt	thickness nut	securing bolt thread	securing bolt length	torque	weight each
t	a	b	c	d	e	f	g	h	i	j	k	ft lb	lbs
120	3 3/4	3 3/4	8 3/16	3 3/4	5 25/32	10 25/32	20 1/2	17 27/32	1 31/32	M12	5 29/32	50.1	243

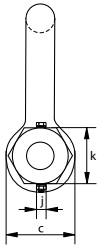



Green Pin® Sling Shackle BN

High load capacity bow shackle with safety bolt

- **Material:** bow and pin alloy steel, grade 8, quenched and tempered
- **Safety Factor:** MBL equals 5 x WLL
- **Finish:** shackle bow painted silver, pin painted green (7 up to 55 ton shackles are hot dipped galvanized)
- **Temperature Range:** -20°C up to +200°C
- **Certification:** 2.1 2.2 3.1 MTC^b * LROS * MPI^b * US^b * CE



P-6033

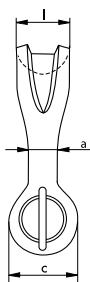
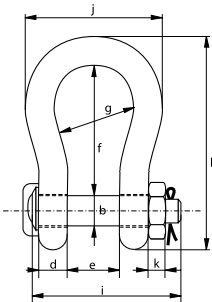

working load limit	diameter body	diameter pin	diameter eye	width eye	width inside	length inside	width bow	length	length bolt	width	thickness nut	bearing surface	weight each
t	a mm	b mm	c mm	d mm	e mm	f mm	g mm	h mm	i mm	j mm	k mm	l mm	kg
7	22	22	46	19	32	96	64	153	115	110	19	41	2
12.5	28	28	61	25	44	121	82	197	151	146	24	54	4
18	35	35	69	30	54	148	102	239	175	180	29	64	7
30	40	42	90	35	69	165	126	279	211	200	34	79	13
40	55	51	109	45	84	199	140	331	252	235	38	97	21
55	60	57	115	55	90	240	160	389	299	270	45	100	30
75	68	70	125	54	110	290	185	473	317	317	40	120	45
125	85	80	154	85	137	366	220	583	413	390	40	150	84
150	94	95	179	89	147	391	253	645	445	434	50	170	117
200	110	105	199	100	158	481	280	759	480	482	50	205	179
250	126	120	227	110	179	542	300	859	535	530	60	240	260
300	135	134	245	122	195	601	350	947	590	620	70	265	350
400	160	160	293	145	231	576	370	985	675	690	80	320	580
500	170	180	328	160	263	681	450	1131	748	790	90	339	780
600	190	200	348	170	289	741	490	1234	809	865	100	370	980
700	200	215	392	190	315	751	540	1284	879	901	100	400	1360
800	218	230	420	200	342	851	554	1426	942	947	110	420	1430
900	242	255	466	220	368	851	580	1488	1023	1023	120	440	1650
1000	260	270	490	240	399	851	614	1532	1103	1107	120	460	2970
1250	285	300	510	260	452	931	650	1666	1227	1182	150	530	3700
1550	285	320	550	280	483	950	680	1710	1300	1253	150	560	4000

In inch

working load limit	diameter body	diameter pin	diameter eye	width eye	width inside	length inside	width bow	length	length bolt	width	thickness nut	bearing surface	weight each
t	a inch	b inch	c inch	d inch	e inch	f inch	g inch	h inch	i inch	j inch	k inch	l inch	lbs
7	7/8	7/8	1 13/16	3/4	1 9/32	3 25/32	2 17/32	6	4 17/32	4 5/16	3/4	1 5/8	4.41
12.5	1 1/8	1 1/8	2 3/8	1	1 3/4	4 3/4	3 1/4	7 3/4	5 15/16	5 3/4	15/16	2 1/8	8.82
18	1 3/8	1 3/8	2 23/32	1 3/16	2 1/8	5 13/16	4 1/32	9 13/32	6 7/8	7 3/32	1 5/32	2 17/32	18
30	1 9/16	1 21/32	3 17/32	1 3/8	2 23/32	6 1/2	4 31/32	10 31/32	8 5/16	7 7/8	1 11/32	3 1/8	29
40	2 5/32	2	4 9/32	1 25/32	3 5/16	7 27/32	5 1/2	13 1/32	9 29/32	9 1/4	1 1/2	3 13/16	46
55	2 3/8	2 1/4	4 17/32	2 5/32	3 17/32	9 7/16	6 5/16	15 5/16	11 25/32	10 5/8	1 25/32	3 15/16	66
75	2 11/16	2 3/4	4 29/32	2 1/8	4 11/32	11 13/32	7 9/32	18 5/8	12 15/32	12 15/32	1 9/16	4 23/32	99
125	3 11/32	3 5/32	6 1/16	3 11/32	5 13/32	14 13/32	8 21/32	22 15/16	16 1/4	15 11/32	1 9/16	5 29/32	185
150	3 11/16	3 3/4	7 1/16	3 1/2	5 25/32	15 13/32	9 31/32	25 13/32	17 17/32	17 3/32	1 31/32	6 11/16	257
200	4 11/32	4 1/8	7 27/32	3 15/16	6 7/32	18 15/16	11 1/32	29 7/8	18 29/32	18 31/32	1 31/32	8 1/16	395
250	4 31/32	4 23/32	8 15/16	4 11/32	7 1/16	21 11/32	11 13/16	33 13/16	21 1/16	20 7/8	2 3/8	9 7/16	571
300	5 5/16	5 9/32	9 21/32	4 13/16	7 11/16	23 21/32	13 25/32	37 9/32	23 7/32	24 13/32	2 3/4	10 7/16	770
400	6 5/16	6 5/16	11 17/32	5 23/32	9 3/32	22 11/16	14 9/16	38 25/32	26 9/16	27 5/32	3 5/32	12 19/32	1279
500	6 11/16	7 3/32	12 29/32	6 5/16	10 11/32	26 13/16	17 23/32	44 17/32	29 7/16	31 3/32	3 17/32	13 11/32	1720
600	7 15/32	7 7/8	13 11/16	6 11/16	11 3/8	29 3/16	19 9/32	48 19/32	31 27/32	34 1/16	3 15/16	14 9/16	2161
700	7 7/8	8 15/32	15 7/16	7 15/32	12 13/32	29 9/16	21 1/4	50 9/16	34 19/32	35 15/32	3 15/16	15 3/4	2998
800	8 19/32	9 1/16	16 17/32	7 7/8	13 15/32	33 1/2	21 13/16	56 5/32	37 3/32	37 9/32	4 11/32	16 17/32	3153
900	9 17/32	10 1/32	18 11/32	8 21/32	14 1/2	33 1/2	22 27/32	58 19/32	40 9/32	40 9/32	4 23/32	17 5/16	3638
1000	10 1/4	10 5/8	19 9/32	9 7/16	15 23/32	33 1/2	24 3/16	60 5/16	43 7/16	43 19/32	4 23/32	18 1/8	6548
1250	11 7/32	11 13/16	20 3/32	10 1/4	17 25/32	36 21/32	25 19/32	65 19/32	48 5/16	46 17/32	5 29/32	20 7/8	8157
1550	11 7/32	12 19/32	21 21/32	11 1/32	19 1/32	37 13/32	26 25/32	67 5/16	51 3/16	49 11/32	5 29/32	22 1/16	8818

CAD RFID

* For shackles ≥ WLL 75 t



Green Pin® Sling Shackle FN

High load capacity bow shackle with safety bolt and fixed nut

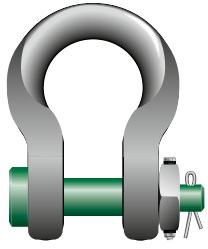

P-6013

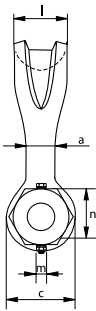
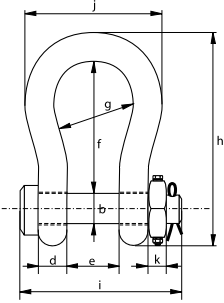

- **Material:** bow and pin alloy steel, grade 8, quenched and tempered
- **Safety Factor:** MBL equals 5 x WLL
- **Finish:** shackle bow painted silver, pin painted green (7 up to 55 ton shackles are hot dipped galvanized)
- **Temperature Range:** -20°C up to +200°C
- **Certification:** 2.1 2.2 3.1 MTC^b * LROS * MPI^b * US^b * CE

working load limit	diameter body	diameter pin	diameter eye	width eye	width inside	length inside	width bow	length bow	length bolt	width	thickness nut	bearing surface	securing bolt thread	securing bolt length	torque	weight each
t	a	b	c	d	e	f	g	h	i	j	k	l	m	n	Nm	kg
7	22	22	46	19	32	96	64	153	115	110	19	41	M6	45	8.4	2
12.5	28	28	61	25	44	121	82	197	151	146	24	54	M8	50	20	4
18	35	35	69	30	54	148	102	239	175	180	29	64	M10	65	39	8
30	40	42	90	35	69	165	126	279	211	200	34	79	M6	75	8.4	13
40	55	51	109	45	84	199	140	331	252	235	38	97	M8	90	20	21
55	60	57	115	55	90	240	160	389	299	270	45	100	M10	100	39	30
75	68	70	125	54	110	290	185	473	317	317	40	120	M12	120	68	45
125	85	80	154	85	137	366	220	583	413	390	40	150	M12	130	68	84
150	94	95	179	89	147	391	253	645	445	434	50	170	M12	140	68	117

In inch

working load limit	diameter body	diameter pin	diameter eye	width eye	width inside	length inside	width bow	length bow	length bolt	width	thickness nut	bearing surface	securing bolt thread	securing bolt length	torque	weight each
t	a	b	c	d	e	f	g	h	i	j	k	l	m	n	ft lb	lbs
7	7/8	7/8	1 13/16	3/4	1 9/32	3 25/32	2 17/32	6	4 17/32	4 5/16	3/4	1 5/8	M6	1 25/32	6.2	4.41
12.5	1 1/8	1 1/8	2 3/8	1	1 3/4	4 3/4	3 1/4	7 3/4	5 15/16	5 3/4	15/16	2 1/8	M8	1 31/32	14.7	8.82
18	1 3/8	1 3/8	2 23/32	1 3/16	2 1/8	5 13/16	4 1/32	9 13/32	6 7/8	7 3/32	1 5/32	2 17/32	M10	2 9/16	28.7	18
30	1 9/16	1 21/32	3 17/32	1 3/8	2 23/32	6 1/2	4 31/32	10 31/32	8 5/16	7 7/8	1 11/32	3 1/8	M6	2 15/16	6.2	29
40	2 5/32	2	4 9/32	1 25/32	3 5/16	7 27/32	5 1/2	13 1/32	9 29/32	9 1/4	1 1/2	3 13/16	M8	3 17/32	14.7	46
55	2 3/8	2 1/4	4 17/32	2 5/32	3 17/32	9 7/16	6 5/16	15 5/16	11 25/32	10 5/8	1 25/32	3 15/16	M10	3 15/16	28.7	66
75	2 11/16	2 3/4	4 29/32	2 1/8	4 11/32	11 13/32	7 9/32	18 5/8	12 15/32	12 15/32	1 9/16	4 23/32	M12	4 23/32	50.1	99
125	3 11/32	3 5/32	6 1/16	3 11/32	5 13/32	14 13/32	8 21/32	22 15/16	16 1/4	15 11/32	1 9/16	5 29/32	M12	5 1/8	50.1	185
150	3 11/16	3 3/4	7 1/16	3 1/2	5 25/32	15 13/32	9 31/32	25 13/32	17 17/32	17 3/32	1 31/32	6 11/16	M12	5 1/2	50.1	257

* For shackles ≥ WLL 75 t



Green Pin Power Sling® Shackle BN

High load capacity, grade 8 shackle with safety bolt



P-6043

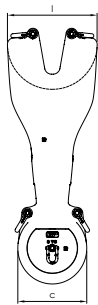
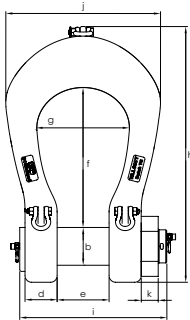

- **Material:** bow and pin alloy steel, grade 8, quenched and tempered
- **Safety Factor:** MBL equals 5 x WLL
- **Finish:** shackle bow painted silver, pin painted green
- **Temperature Range:** -40°C up to +200°C
- **Certification:** 2.1 2.2 3.1 MTC[®] LROS MPI[®] US[®] DNV GL 0377 DNV GL 0378 CE

working load limit	diameter pin	diameter eye	width eye	width inside	length inside	width bow	length	length bolt	width	thickness nut	bearing surface	weight each
t	b mm	c mm	d mm	e mm	f mm	g mm	h mm	i mm	j mm	k mm	l mm	kg
125	80	166	85	134	364	220	631	382	370	36	205	95
150	95	182	90	144	389	250	703	408	420	42	248	134
200	105	204	100	154	479	276	838	446	475	47	290	195
250	120	238	110	174	539	300	938	503	515	60	314	271
300	134	260	121	189	599	350	1031	550	605	60	345	368
400	160	305	140	224	620	370	1123	645	652	80	392	563
500	180	340	152	255	679	450	1239	714	763	85	440	786
600	200	365	170	280	739	490	1353	788	820	90	475	1009
700	215	405	190	320	750	540	1415	879	895	100	512	1288
800	230	430	200	347	850	554	1547	942	917	108	536	1503
900	255	476	215	373	850	580	1598	1013	970	120	560	1849
1000	270	500	232	404	850	614	1642	1085	1022	125	590	2188
1250	300	570	245	442	928	650	1812	1164	1144	140	670	2933

In inch

working load limit	diameter pin	diameter eye	width eye	width inside	length inside	width bow	length	length bolt	width	thickness nut	bearing surface	weight each
t	b inch	c inch	d inch	e inch	f inch	g inch	h inch	i inch	j inch	k inch	l inch	lbs
125	3 ^{5/32}	6 ^{17/32}	3 ^{11/32}	5 ^{9/32}	14 ^{11/32}	8 ^{21/32}	24 ^{27/32}	15 ^{1/32}	14 ^{9/16}	1 ^{13/32}	8 ^{1/16}	210
150	3 ^{3/4}	7 ^{5/32}	3 ^{17/32}	5 ^{21/32}	15 ^{5/16}	9 ^{27/32}	27 ^{11/16}	16 ^{1/16}	16 ^{17/32}	1 ^{21/32}	9 ^{3/4}	296
200	4 ^{1/8}	8 ^{1/32}	3 ^{15/16}	6 ^{1/16}	18 ^{7/8}	10 ^{7/8}	33	17 ^{9/16}	18 ^{11/16}	1 ^{27/32}	11 ^{13/32}	430
250	4 ^{23/32}	9 ^{3/8}	4 ^{11/32}	6 ^{27/32}	21 ^{7/32}	11 ^{13/16}	36 ^{15/16}	19 ^{13/16}	20 ^{9/32}	2 ^{3/8}	12 ^{3/8}	598
300	5 ^{9/32}	10 ^{1/4}	4 ^{3/4}	7 ^{7/16}	23 ^{19/32}	13 ^{25/32}	40 ^{19/32}	21 ^{21/32}	23 ^{13/16}	2 ^{3/8}	13 ^{19/32}	812
400	6 ^{5/16}	12	5 ^{1/2}	8 ^{13/16}	24 ^{13/32}	14 ^{9/16}	42 ^{7/16}	25 ^{3/8}	25 ^{21/32}	3 ^{5/32}	15 ^{7/16}	1242
500	7 ^{3/32}	13 ^{3/8}	5 ^{31/32}	10 ^{1/32}	26 ^{23/32}	17 ^{23/32}	48 ^{25/32}	28 ^{1/8}	30 ^{1/32}	3 ^{11/32}	17 ^{5/16}	1733
600	7 ^{7/8}	14 ^{3/8}	6 ^{11/16}	11 ^{1/32}	29 ^{3/32}	19 ^{9/32}	53 ^{9/32}	31 ^{1/32}	32 ^{9/32}	3 ^{17/32}	18 ^{11/16}	2225
700	8 ^{15/32}	15 ^{15/16}	7 ^{15/32}	12 ^{19/32}	29 ^{17/32}	21 ^{1/4}	55 ^{23/32}	34 ^{19/32}	35 ^{1/4}	3 ^{15/16}	20 ^{5/32}	2840
800	9 ^{1/16}	16 ^{15/16}	7 ^{7/8}	13 ^{21/32}	33 ^{15/32}	21 ^{13/16}	60 ^{29/32}	37 ^{3/32}	36 ^{3/32}	4 ^{1/4}	21 ^{3/32}	3314
900	10 ^{1/32}	18 ^{3/4}	8 ^{15/32}	14 ^{11/16}	33 ^{15/32}	22 ^{27/32}	62 ^{29/32}	39 ^{7/8}	38 ^{3/16}	4 ^{23/32}	22 ^{1/16}	4077
1000	10 ^{5/8}	19 ^{11/16}	9 ^{1/8}	15 ^{29/32}	33 ^{15/32}	24 ^{3/16}	64 ^{21/32}	42 ^{23/32}	40 ^{1/4}	4 ^{29/32}	23 ^{7/32}	4824
1250	11 ^{13/16}	22 ^{7/16}	9 ^{21/32}	17 ^{13/32}	36 ^{17/32}	25 ^{19/32}	71 ^{11/32}	45 ^{27/32}	45 ^{1/32}	5 ^{1/2}	26 ^{3/8}	6467

CAD RFID





Green Pin Super® Bow Shackle SC

Grade 8 bow shackle with screw pin



G-5261

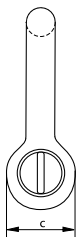
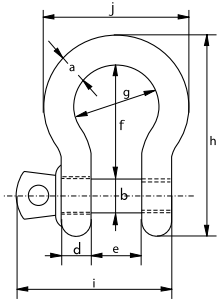

- **Material:** bow and pin alloy steel, grade 8, quenched and tempered
- **Safety Factor:** MBL equals 5 x WLL
- **Standard:** ASME B30.26 and meets performance requirements of US Fed. Spec. RR-C-271 Type IVA Class 2, grade B
- **Finish:** hot dipped galvanized
- **Temperature Range:** -20°C up to +200°C
- **Certification:** 2.1 2.2 3.1 MTC[®] CE ABS PDA ABS MA

working load limit	diameter body	diameter pin	diameter eye	width eye	width inside	length inside	width bow	length	length bolt	width	weight each
t	a mm	b mm	c mm	d mm	e mm	f mm	g mm	h mm	i mm	j mm	kg
3.3	13.5	16	34	13	22	51	32	89	73	58	0.36
5	16	19	40	16	27	64	43	110	89	75	0.63
7	19	22	46	19	31	76	51	129	103	89	1.01
9.5	22	25	52	22	36	83	58	144	119	102	1.5
12.5	25	28	59	25	43	95	68	164	137	118	2.21

In inch

working load limit	diameter body	diameter pin	diameter eye	width eye	width inside	length inside	width bow	length	length bolt	width	weight each
t	a inch	b inch	c inch	d inch	e inch	f inch	g inch	h inch	i inch	j inch	lbs
3.3	1/2	5/8	1 11/32	1/2	7/8	2	1 1/4	3 1/2	2 7/8	2 9/32	0.79
5	5/8	3/4	1 9/16	5/8	1 1/16	2 17/32	1 11/16	4 11/32	3 1/2	2 15/16	1.38
7	3/4	7/8	1 13/16	3/4	1 7/32	3	2	5 3/32	4 1/16	3 1/2	2.22
9.5	7/8	1	2 1/16	7/8	1 13/32	3 9/32	2 9/32	5 21/32	4 11/16	4 1/32	3.31
12.5	1	1 1/8	2 5/16	31/32	1 11/16	3 3/4	2 11/16	6 15/32	5 13/32	4 21/32	4.86

CAD RFID





Green Pin Super® Bow Shackle BN

Grade 8 bow shackle with safety bolt

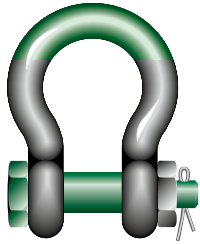

G-5263

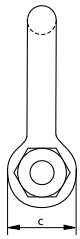
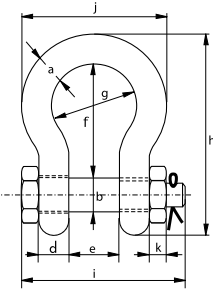

- **Material:** bow and pin alloy steel, grade 8, quenched and tempered
- **Safety Factor:** MBL equals 5 x WLL
- **Standard:** ASME B30.26 and meets performance requirements of US Fed. Spec. RR-C-271 Type IVA Class 3, grade B
- **Finish:** hot dipped galvanized (175 ton shackle is painted)
- **Temperature Range:** -20°C up to +200°C
- **Certification:** 2.1 2.2 3.1 MTC^a MTC^b * LROS * CE ABS PDA ABS MA

working load limit	diameter bow	diameter pin	diameter eye	width eye	width inside	length inside	width bow	length	length bolt	width	thickness nut	weight each
t	a mm	b mm	c mm	d mm	e mm	f mm	g mm	h mm	i mm	j mm	k mm	kg
3.3	13.5	16	34	13	22	51	32	89	82	58	13	0.40
5	16	19	40	16	27	64	43	110	98	75	17	0.73
7	19	22	46	19	31	76	51	129	114	89	19	1.19
9.5	22	25	52	22	36	83	58	144	130	102	22	1.73
12.5	25	28	59	25	43	95	68	164	150	118	25	2.56
15	28	32	66	28	47	108	75	185	166	131	27	3.6
18	32	35	72	32	51	115	83	201	178	147	30	4.95
21	35	38	80	35	57	133	92	227	197	162	33	6.62
30	38	42	88	38	60	146	99	249	217	175	34	8.11
40	45	50	103	45	74	178	126	300	260	216	40	15
55	57	57	117	57	83	197	138	341	303	252	46	23
85	70	70	143	70	105	260	180	437	363	320	56	44
120	83	83	162	83	127	329	190	535	425	356	66	72
150**	95	95	208	95	147	400	238	647	524	428	50	112
175**	105	108	238	105	169	410	275	688	567	485	50	160

In inch

working load limit	diameter bow	diameter pin	diameter eye	width eye	width inside	length inside	width bow	length	length bolt	width	thickness nut	weight each
t	a inch	b inch	c inch	d inch	e inch	f inch	g inch	h inch	i inch	j inch	k inch	lbs
3.3	1/2	5/8	1 11/32	1/2	7/8	2	1 1/4	3 1/2	3 7/32	2 9/32	1/2	0.88
5	5/8	3/4	1 9/16	5/8	1 1/16	2 17/32	1 11/16	4 11/32	3 27/32	2 15/16	21/32	1.61
7	3/4	7/8	1 13/16	3/4	1 7/32	3	2	5 3/32	4 1/2	3 1/2	3/4	2.62
9.5	7/8	1	2 1/16	7/8	1 13/32	3 9/32	2 9/32	5 21/32	5 1/8	4 1/32	7/8	3.81
12.5	1	1 1/8	2 5/16	31/32	1 11/16	3 3/4	2 11/16	6 15/32	5 29/32	4 21/32	31/32	5.64
15	1 1/8	1 1/4	2 19/32	1 3/32	1 27/32	4 1/4	2 15/16	7 9/32	6 17/32	5 5/32	1 1/16	7.94
18	1 1/4	1 3/8	2 27/32	1 1/4	2	4 17/32	3 9/32	7 29/32	7	5 25/32	1 3/16	10.91
21	1 3/8	1 1/2	3 5/32	1 3/8	2 1/4	5 1/4	3 5/8	8 15/16	7 3/4	6 3/8	1 5/16	14.59
30	1 1/2	1 5/8	3 15/32	1 1/2	2 3/8	5 3/4	3 29/32	9 13/16	8 17/32	6 7/8	1 5/16	17.88
40	1 3/4	2	4 1/16	1 25/32	2 29/32	7	4 31/32	11 13/16	10 1/4	8 1/2	1 9/16	33.07
55	2	2 1/4	4 19/32	2 1/4	3 9/32	7 3/4	5 7/16	13 7/16	11 15/16	9 29/32	1 25/32	50.71
85	2 1/2	2 3/4	5 5/8	2 3/4	4 1/8	10 1/4	7 3/32	17 7/32	14 9/32	12 19/32	2 7/32	97
120	3	3 1/4	6 3/8	3 9/32	5	12 15/16	7 15/32	21 1/16	16 23/32	14 1/32	2 5/8	158.73
150**	3 3/4	3 3/4	8 3/16	3 3/4	5 25/32	15 3/4	9 3/8	25 15/32	20 5/8	16 27/32	1 31/32	246.92
175**	4	4 1/4	9 3/8	4 1/8	6 21/32	16 5/32	10 13/16	27 3/32	22 5/16	19 3/32	1 31/32	352.74

CAD RFID



- * For shackles \geq WLL 150t
- ** With round headed bolt
- ** Excluded from ABS Type Approval

Green Pin Super® Bow Shackle FN

Grade 8 bow shackle with safety bolt and fixed nut

- **Material:** bow and pin alloy steel, grade 8, quenched and tempered
- **Safety Factor:** MBL equals 5 x WLL
- **Standard:** ASME B30.26 and meets performance requirements of US Fed. Spec. RR-C-271 Type IVA Class 3, grade B
- **Finish:** hot dipped galvanized (175 ton shackle is painted)
- **Temperature Range:** -20°C up to +200°C
- **Certification:** 2.1 2.2 3.1 MTC^a MTC^b * LROS * CE

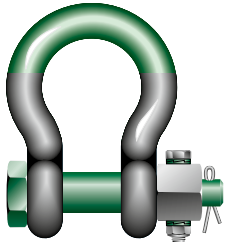

G-5243

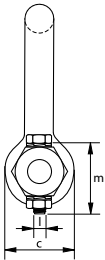
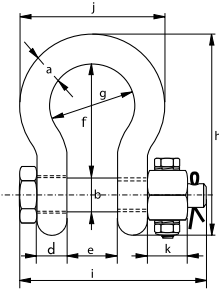

working load limit	diameter bow	diameter pin	diameter eye	width eye	width inside	length inside	width bow	length	length	length	width	thickness nut	securing bolt thread	securing bolt length	torque	weight each
t	a	b	c	d	e	f	g	h	i	j	k	l	m	Nm	kg	
3.3	13.5	16	34	13	22	51	32	89	82	58	13	M6	35	8.4	0.40	
5	16	19	40	16	27	64	43	110	98	75	17	M6	40	8.4	0.73	
7	19	22	46	19	31	76	51	129	114	89	19	M6	45	8.4	1.19	
9.5	22	25	52	22	36	83	58	144	130	102	22	M8	50	20	1.73	
12.5	25	28	59	25	43	95	68	164	150	118	25	M8	55	20	2.56	
15	28	32	66	28	47	108	75	185	166	131	27	M10	60	39	3.6	
18	32	35	72	32	51	115	83	201	178	147	30	M10	65	39	4.95	
21	35	38	80	35	57	133	92	227	197	162	33	M10	70	39	6.62	
30	38	42	88	38	60	146	99	249	217	175	34	M8	75	20	8.11	
40	45	50	103	45	74	178	126	300	260	216	40	M8	90	20	15	
55	57	57	117	57	83	197	138	341	303	252	46	M10	100	39	23	
85	70	70	143	70	105	260	180	437	363	320	56	M12	120	68	44	
120	83	83	162	83	127	329	190	535	425	356	66	M12	140	68	72	
150**	95	95	208	95	147	400	238	647	524	428	50	M12	150	68	112	
175**	105	108	238	105	169	410	275	688	567	485	50	M12	160	68	160	

In inch

working load limit	diameter bow	diameter pin	diameter eye	width eye	width inside	length inside	width bow	length	length	length	width	thickness nut	securing bolt thread	securing bolt length	torque	weight each
t	a	b	c	d	e	f	g	h	i	j	k	l	m	ft lb	lbs	
3.3	1/2	5/8	1 11/32	1/2	7/8	2	1 1/4	3 1/2	3 7/32	2 9/32	1/2	M6	1 3/8	6.2	0.88	
5	5/8	3/4	1 9/16	5/8	1 1/16	2 17/32	1 11/16	4 11/32	3 27/32	2 15/16	2 1/32	M6	1 9/16	6.2	1.61	
7	3/4	7/8	1 13/16	3/4	1 7/32	3	2	5 3/32	4 1/2	3 1/2	3/4	M6	1 25/32	6.2	2.62	
9.5	7/8	1	2 1/16	7/8	1 13/32	3 9/32	2 9/32	5 21/32	5 1/8	4 1/32	7/8	M8	1 31/32	14.7	3.81	
12.5	1	1 1/8	2 5/16	31/32	1 11/16	3 3/4	2 11/16	6 15/32	5 29/32	4 21/32	31/32	M8	2 5/32	14.7	5.64	
15	1 1/8	1 1/4	2 19/32	1 3/32	1 27/32	4 1/4	2 15/16	7 9/32	6 17/32	5 5/32	1 1/16	M10	2 3/8	28.7	7.94	
18	1 1/4	1 3/8	2 27/32	1 1/4	2	4 17/32	3 9/32	7 29/32	7	5 25/32	1 3/16	M10	2 9/16	28.7	10.91	
21	1 3/8	1 1/2	3 5/32	1 3/8	2 1/4	5 1/4	3 5/8	8 15/16	7 3/4	6 3/8	1 5/16	M10	2 3/4	28.7	14.59	
30	1 1/2	1 5/8	3 15/32	1 1/2	2 3/8	5 3/4	3 29/32	9 13/16	8 17/32	6 7/8	1 5/16	M8	2 15/16	14.7	17.88	
40	1 3/4	2	4 1/16	1 25/32	2 29/32	7	4 31/32	11 13/16	10 1/4	8 1/2	1 9/16	M8	3 17/32	14.7	33.07	
55	2	2 1/4	4 19/32	2 1/4	3 9/32	7 3/4	5 7/16	13 7/16	11 15/16	9 29/32	1 25/32	M10	3 15/16	28.7	50.71	
85	2 1/2	2 3/4	5 5/8	2 3/4	4 1/8	10 1/4	7 3/32	17 7/32	14 9/32	12 19/32	2 7/32	M12	4 23/32	50.1	97	
120	3	3 1/4	6 3/8	3 9/32	5	12 15/16	7 15/32	21 1/16	16 23/32	14 1/32	2 5/8	M12	5 1/2	50.1	158.73	
150**	3 3/4	3 3/4	8 3/16	3 3/4	5 25/32	15 3/4	9 3/8	25 15/32	20 5/8	16 27/32	1 31/32	M12	5 29/32	50.1	246.92	
175**	4	4 1/4	9 3/8	4 1/8	6 21/32	16 5/32	10 13/16	27 3/32	22 5/16	19 3/32	1 31/32	M12	6 5/16	50.1	352.74	

* For shackles ≥ WLL 150t

** With round headed bolt



Green Pin Polar® Bow Shackle BN

Grade 8 bow shackle with safety bolt for use under low temperatures

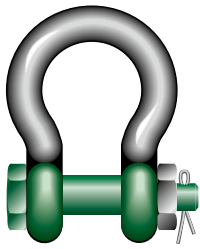

G-5163

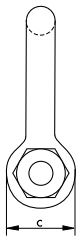
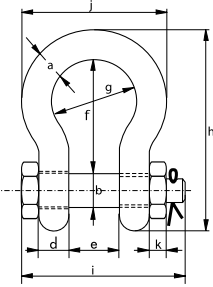

- **Material:** bow and pin alloy steel, grade 8, quenched and tempered
- **Safety Factor:** MBL equals 7 x WLL
for shackles with WLL 55 and 85 tons the MBL equals 6 x WLL
- **Standard:** EN 13889, ASME B30.26 and meets performance requirements of US Fed. Spec. RR-C-271 Type IVA Class 3, grade A
- **Finish:** hot dipped galvanized
- **Temperature Range:** -60°C up to +200°C
- **Certification:** 2.1 2.2 3.1 MTC^a DNV GL 2.7-1^a DNV GL 2.7-1^b DNV GL 0378 CE ABS PDA ABS MA

working load limit	diameter bow	diameter pin	diameter eye	width eye	width inside	length inside	width bow	length	length bolt	width	thickness nut	weight each
t	a mm	b mm	c mm	d mm	e mm	f mm	g mm	h mm	i mm	j mm	k mm	kg
2	13.5	16	34	13	22	51	32	89	82	58	13	0.42
3.25	16	19	40	16	27	64	43	110	98	75	17	0.74
4.75	19	22	46	19	31	76	51	129	114	89	19	1.18
6.5	22	25	52	22	36	83	58	144	130	102	22	1.77
8.5	25	28	59	25	43	95	68	164	150	118	25	2.58
9.5	28	32	66	28	47	108	75	185	166	131	27	3.66
12	32	35	72	32	51	115	83	201	178	147	30	4.91
13.5	35	38	80	35	57	133	92	227	197	162	33	6.54
17	38	42	88	38	60	146	99	249	202	175	19	8.19
25	45	50	103	45	74	178	126	300	249	216	23	14.22
35	50	57	116	50	83	197	138	334	269	238	26	19.85
42.5	57	65	130	57	95	222	160	377	301	274	29	28.33
55	65	70	145	65	105	260	180	433	330	310	32	39.59
85	75	83	162	73	127	329	190	527	380	340	39	62

In inch

working load limit	diameter bow	diameter pin	diameter eye	width eye	width inside	length inside	width bow	length	length bolt	width	thickness nut	weight each
t	a inch	b inch	c inch	d inch	e inch	f inch	g inch	h inch	i inch	j inch	k inch	lbs
2	1/2	5/8	1 11/32	1/2	7/8	2	1 1/4	3 1/2	3 7/32	2 9/32	1/2	0.92
3.25	5/8	3/4	1 9/16	5/8	1 1/16	2 17/32	1 11/16	4 11/32	3 27/32	2 15/16	21/32	1.62
4.75	3/4	7/8	1 13/16	3/4	1 7/32	3	2	5 3/32	4 1/2	3 1/2	3/4	2.59
6.5	7/8	1	2 1/16	7/8	1 13/32	3 9/32	2 9/32	5 21/32	5 1/8	4 1/32	7/8	3.9
8.5	1	1 1/8	2 5/16	31/32	1 11/16	3 3/4	2 11/16	6 15/32	5 29/32	4 21/32	31/32	5.69
9.5	1 1/8	1 1/4	2 19/32	1 3/32	1 27/32	4 1/4	2 15/16	7 9/32	6 17/32	5 5/32	1 1/16	8.06
12	1 1/4	1 3/8	2 27/32	1 1/4	2	4 17/32	3 9/32	7 29/32	7	5 25/32	1 3/16	10.81
13.5	1 3/8	1 1/2	3 5/32	1 3/8	2 1/4	5 1/4	3 5/8	8 15/16	7 3/4	6 3/8	1 5/16	14.42
17	1 1/2	1 5/8	3 15/32	1 1/2	2 3/8	5 3/4	3 29/32	9 13/16	7 15/16	6 7/8	3/4	18.06
25	1 3/4	2	4 1/16	1 25/32	2 29/32	7	4 31/32	11 13/16	9 13/16	8 1/2	29/32	31.34
35	2	2 1/4	4 9/16	1 31/32	3 9/32	7 3/4	5 7/16	13 5/32	10 19/32	9 3/8	1 1/32	43.77
42.5	2 1/4	2 9/16	5 1/8	2 1/4	3 3/4	8 3/4	6 5/16	14 27/32	11 27/32	10 25/32	1 5/32	62.46
55	2 1/2	2 3/4	5 23/32	2 9/16	4 1/8	10 1/4	7 3/32	17 1/16	13	12 7/32	1 1/4	87.27
85	3	3 1/4	6 3/8	2 7/8	5	12 15/16	7 15/32	20 3/4	14 31/32	13 3/8	1 17/32	136.69

CAD RFID





Green Pin Polar® Bow Shackle FN

Grade 8 bow shackle with safety bolt and fixed nut for use under low temperatures

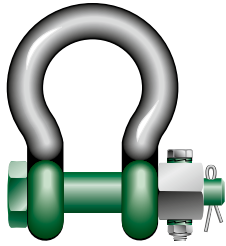

- **Material:** bow and pin alloy steel, grade 8, quenched and tempered
- **Safety Factor:** MBL equals 7 x WLL
- **Standard:** EN 13889, ASME B30.26 and meets performance requirements of US Fed. Spec. RR-C-271 Type IVA Class 3, grade A
- **Finish:** hot dipped galvanized
- **Temperature range:** -60°C up to +200°C
- **Certification:** 2.1 2.2 3.1 MTC^a DNV GL 2.7-1^a DNV GL 2.7-1^b CE

G-5143

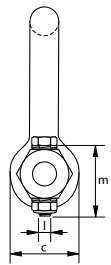
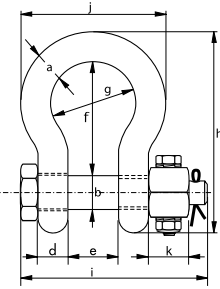

working load limit	diameter bow	diameter pin	diameter eye	width eye	width inside	length inside	width bow	length	length bolt	width	thickness nut	securing bolt thread	securing bolt length	torque	weight each
t	a mm	b mm	c mm	d mm	e mm	f mm	g mm	h mm	i mm	j mm	k mm	l mm	m mm	Nm	kg
2	13.5	16	34	13	22	51	32	89	82	58	13	M6	35	8.4	0.42
3.25	16	19	40	16	27	64	43	110	98	75	17	M6	40	8.4	0.74
4.75	19	22	46	19	31	76	51	129	114	89	19	M6	45	8.4	1.18
6.5	22	25	52	22	36	83	58	144	130	102	22	M8	50	20	1.77
8.5	25	28	59	25	43	95	68	164	150	118	25	M8	55	20	2.58
9.5	28	32	66	28	47	108	75	185	166	131	27	M10	60	39	3.66
12	32	35	72	32	51	115	83	201	178	147	30	M10	65	39	4.91
13.5	35	38	80	35	57	133	92	227	197	162	33	M10	70	39	6.54
17	38	42	88	38	60	146	99	249	202	175	19	M8	75	20	8.19
25	45	50	103	45	74	178	126	300	249	216	23	M8	90	20	14.22
35	50	57	116	50	83	197	138	334	269	238	26	M10	100	39	19.85
42.5	57	65	130	57	95	222	160	377	301	274	29	M12	110	68	28.33
55	65	70	145	65	105	260	180	433	330	310	32	M12	120	68	39.59
85	75	83	162	73	127	329	190	527	380	340	39	M12	140	68	62

In inch

working load limit	diameter bow	diameter pin	diameter eye	width eye	width inside	length inside	width bow	length	length bolt	width	thickness nut	securing bolt thread	securing bolt length	torque	weight each
t	a inch	b inch	c inch	d inch	e inch	f inch	g inch	h inch	i inch	j inch	k inch	l mm	m inch	ft lb	lbs
2	1/2	5/8	1 11/32	1/2	7/8	2	1 1/4	3 1/2	3 7/32	2 9/32	1/2	M6	1 3/8	6.2	0.92
3.25	5/8	3/4	1 9/16	5/8	1 1/16	2 17/32	1 11/16	4 11/32	3 27/32	2 15/16	21/32	M6	1 9/16	6.2	1.62
4.75	3/4	7/8	1 13/16	3/4	1 7/32	3	2	5 3/32	4 1/2	3 1/2	3/4	M6	1 25/32	6.2	2.59
6.5	7/8	1	2 1/16	7/8	1 13/32	3 9/32	2 9/32	5 21/32	5 1/8	4 1/32	7/8	M8	1 31/32	14.7	3.9
8.5	1	1 1/8	2 5/16	31/32	1 11/16	3 3/4	2 11/16	6 15/32	5 29/32	4 21/32	31/32	M8	2 5/32	14.7	5.69
9.5	1 1/8	1 1/4	2 19/32	1 3/32	1 27/32	4 1/4	2 15/16	7 9/32	6 17/32	5 5/32	1 1/16	M10	2 3/8	28.7	8.06
12	1 1/4	1 3/8	2 27/32	1 1/4	2	4 17/32	3 9/32	7 29/32	7	5 25/32	1 3/16	M10	2 9/16	28.7	10.81
13.5	1 3/8	1 1/2	3 5/32	1 3/8	2 1/4	5 1/4	3 5/8	8 15/16	7 3/4	6 3/8	1 5/16	M10	2 3/4	28.7	14.42
17	1 1/2	1 5/8	3 15/32	1 1/2	2 3/8	5 3/4	3 29/32	9 13/16	7 15/16	6 7/8	3/4	M8	2 15/16	14.7	18.06
25	1 3/4	2	4 1/16	1 25/32	2 29/32	7	4 31/32	11 13/16	9 13/16	8 1/2	29/32	M8	3 17/32	14.7	31.34
35	2	2 1/4	4 9/16	1 31/32	3 9/32	7 3/4	5 7/16	13 5/32	10 19/32	9 3/8	1 1/32	M10	3 15/16	28.7	43.77
42.5	2 1/4	2 9/16	5 1/8	2 1/4	3 3/4	8 3/4	6 5/16	14 27/32	11 27/32	10 25/32	1 5/32	M12	4 11/32	50.1	62.46
55	2 1/2	2 3/4	5 23/32	2 9/16	4 1/8	10 1/4	7 3/32	17 1/16	13	12 7/32	1 1/4	M12	4 23/32	50.1	87.27
85	3	3 1/4	6 3/8	2 7/8	5	12 15/16	7 15/32	20 3/4	14 31/32	13 3/8	1 17/32	M12	5 1/2	50.1	136.69





Green Pin Polar® Heavy Duty Bow Shackle BN

High load capacity, grade 8 bow shackle with safety bolt for use under low temperatures

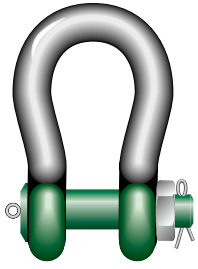

P-6031

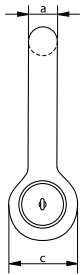
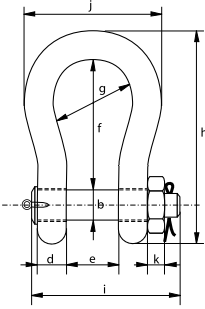

- **Material:** bow and pin alloy steel, grade 8, quenched and tempered
- **Safety Factor:** MBL equals 5 x WLL
- **Standard:** ASME B30.26
- **Finish:** shackle bow painted silver, pin painted green (120 tons shackle is hot dipped galvanized)
- **Temperature Range:** -40°C up to +200°C
- **Certification:** 2.1 2.2 3.1 MTC^a MTC^b * LROS * MPI^a * US^a * CE

working load limit	diameter bow	diameter pin	diameter eye	width eye	width inside	length inside	width bow	length	length bolt	width	thickness nut	weight each
t	a mm	b mm	c mm	d mm	e mm	f mm	g mm	h mm	i mm	j mm	k mm	kg
120	95	95	208	95	147	400	238	647	453	428	50	110
150	105	108	238	105	169	410	275	688	496	485	50	160
200	120	130	279	120	179	513	290	838	564	530	70	235
250	130	140	299	130	205	554	305	904	614	565	70	295
300	140	150	325	140	205	618	305	996	644	585	80	368
400	170	175	376	164	231	668	325	1114	690	665	70	560
500	180	185	398	164	256	718	350	1190	720	710	70	685
600	200	205	444	189	282	718	375	1243	810	775	70	880
700	210	215	454	204	308	718	400	1263	870	820	70	980
800	210	220	464	204	308	718	400	1270	870	820	70	1100
900	220	230	485	215	328	718	420	1296	920	860	70	1280
1000	240	240	515	215	349	718	420	1336	940	900	70	1460
1250	260	270	585	230	369	768	450	1456	1025	970	70	1990
1500	280	290	625	230	369	818	450	1556	1025	1010	70	2400

In inch

working load limit	diameter bow	diameter pin	diameter eye	width eye	width inside	length inside	width bow	length	length bolt	width	thickness nut	weight each
t	a inch	b inch	c inch	d inch	e inch	f inch	g inch	h inch	i inch	j inch	k inch	lbs
120	3 3/4	3 3/4	8 3/16	3 3/4	5 25/32	15 3/4	9 3/8	25 15/32	17 27/32	16 27/32	1 31/32	243
150	4 1/8	4 1/4	9 3/8	4 1/8	6 21/32	16 5/32	10 13/16	27 3/32	19 17/32	19 3/32	1 31/32	353
200	4 23/32	5 1/8	10 31/32	4 23/32	7 1/16	20 3/16	11 13/32	33	22 3/16	20 7/8	2 3/4	518
250	5 1/8	5 1/2	11 25/32	5 1/8	8 1/16	21 13/16	12	35 19/32	24 5/32	22 1/4	2 3/4	650
300	5 1/2	5 29/32	12 25/32	5 1/2	8 1/16	24 11/32	12	39 7/32	25 11/32	23 1/32	3 5/32	811
400	6 11/16	6 7/8	14 13/16	6 15/32	9 3/32	26 5/16	12 25/32	43 27/32	27 5/32	26 3/16	2 3/4	1235
500	7 3/32	7 9/32	15 21/32	6 15/32	10 3/32	28 9/32	13 25/32	46 27/32	28 11/32	27 15/16	2 3/4	1510
600	7 7/8	8 1/16	17 15/32	7 7/16	11 3/32	28 9/32	14 3/4	48 15/16	31 7/8	30 1/2	2 3/4	1940
700	8 9/32	8 15/32	17 7/8	8 1/32	12 1/8	28 9/32	15 3/4	49 23/32	34 1/4	32 9/32	2 3/4	2161
800	8 9/32	8 21/32	18 9/32	8 1/32	12 1/8	28 9/32	15 3/4	50	34 1/4	32 9/32	2 3/4	2425
900	8 21/32	9 1/16	19 3/32	8 15/32	12 29/32	28 9/32	16 17/32	51 1/32	36 7/32	33 27/32	2 3/4	2822
1000	9 7/16	9 7/16	20 9/32	8 15/32	13 3/4	28 9/32	16 17/32	52 19/32	37	35 7/16	2 3/4	3219
1250	10 1/4	10 5/8	23 1/32	9 1/16	14 17/32	30 1/4	17 23/32	57 5/16	40 11/32	38 3/16	2 3/4	4387
1500	11 1/32	11 13/32	24 19/32	9 1/16	14 17/32	32 7/32	17 23/32	61 1/4	40 11/32	39 3/4	2 3/4	5291

CAD RFID

* For shackles ≥ WLL 150 t



Green Pin Polar® Heavy Duty Bow Shackle FN

High load capacity, grade 8 bow shackle with safety bolt and fixed nut for use under low temperatures

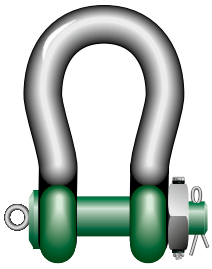

P-6011

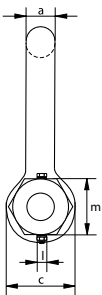
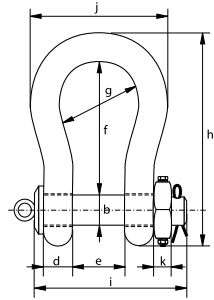

- **Material:** bow and pin alloy steel, grade 8, quenched and tempered
- **Safety Factor:** MBL equals 5 x WLL
- **Standard:** ASME B30.26
- **Finish:** 120 tons shackle: hot dipped galvanized
150 tons shackle: bow painted silver, pin painted green
- **Temperature range:** -40°C up to +200°C
- **Certification:** 2.1 2.2 3.1 MTC^a MTC^b * LROS * MPI^a US^a CE

working load limit	diameter bow	diameter pin	diameter eye	width eye	width inside	length inside	width bow	length	length bolt	width	thickness nut	securing bolt thread	securing bolt length	torque	weight each
t	a	b	c	d	e	f	g	h	i	j	k	l	m	Nm	kg
120	95	95	208	95	147	399	238	646	453	428	50	M12	150	68	110
150	105	108	238	105	169	410	275	688	496	485	50	M12	160	68	160

In inch

working load limit	diameter bow	diameter pin	diameter eye	width eye	width inside	length inside	width bow	length	length bolt	width	thickness nut	securing bolt thread	securing bolt length	torque	weight each
t	a	b	c	d	e	f	g	h	i	j	k	l	m	ft lb	lbs
120	3 3/4	3 3/4	8 3/16	3 3/4	5 25/32	15 3/4	9 3/8	25 15/32	17 27/32	16 27/32	1 31/32	M12	5 29/32	50.1	243
150	4 1/8	4 1/4	9 3/8	4 1/8	6 21/32	16 5/32	10 13/16	27 3/32	19 17/32	19 3/32	1 31/32	M12	6 5/16	50.1	353

* For shackles ≥ WLL 150 t



Green Pin BigMouth® Bow Shackle BN

Grade 8 bow shackle with safety bolt and wider shackle mouth

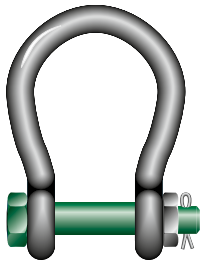

G-4263

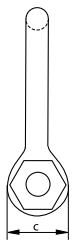
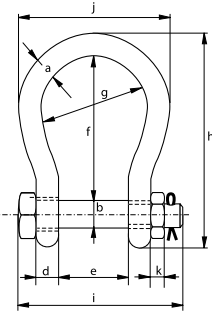

- **Material:** bow and pin alloy steel, grade 8, quenched and tempered
- **Safety Factor:** MBL equals 6 x WLL
- **Standard:** ASME B30.26
- **Finish:** hot dipped galvanized
- **Temperature Range:** -20°C up to +200°C
- **Certification:** 2.1 2.2 3.1 MTC^a CE

working load limit	diameter bow	diameter pin	diameter eye	width eye	width inside	length inside	width bow	length	length bolt	width	thickness nut	weight each
t	a mm	b mm	c mm	d mm	e mm	f mm	g mm	h mm	i mm	j mm	k mm	kg
4.75	22	25	52	22	63	112	88	173	157	132	22	2.08
6.5	25	28	59	25	75	135	105	204	183	155	25	3.14
8.5	28	32	66	28	82	148	115	225	205	171	27	4.36
9.5	32	35	72	32	90	162	126	248	224	190	30	5.95
12	35	38	79	35	100	180	140	274	245	210	33	7.87
16	38	42	88	38	106	216	159	319	248	235	19	12.5
25	45	50	103	45	127	248	175	370	296	265	23	16.7
30	50	57	118	50	146	273	207	411	332	307	26	25
55	65	70	145	65	165	314	213	487	389	343	32	45
75	83	83	164	83	184	330	254	537	455	420	39	77

In inch

working load limit	diameter bow	diameter pin	diameter eye	width eye	width inside	length inside	width bow	length	length bolt	width	thickness nut	weight each
t	a inch	b inch	c inch	d inch	e inch	f inch	g inch	h inch	i inch	j inch	k inch	lbs
4.75	$\frac{7}{8}$	1	$2\frac{1}{16}$	$\frac{7}{8}$	$2\frac{15}{32}$	$4\frac{13}{32}$	$3\frac{15}{32}$	$6\frac{13}{16}$	$6\frac{3}{16}$	$5\frac{3}{16}$	$\frac{7}{8}$	4.59
6.5	1	$1\frac{1}{8}$	$2\frac{5}{16}$	$\frac{31}{32}$	$2\frac{15}{16}$	$5\frac{5}{16}$	$4\frac{1}{8}$	$8\frac{1}{32}$	$7\frac{7}{32}$	$6\frac{3}{32}$	$\frac{31}{32}$	6.92
8.5	$1\frac{1}{8}$	$1\frac{1}{4}$	$2\frac{19}{32}$	$1\frac{3}{32}$	$3\frac{7}{32}$	$5\frac{13}{16}$	$4\frac{17}{32}$	$8\frac{27}{32}$	$8\frac{1}{16}$	$6\frac{23}{32}$	$1\frac{1}{16}$	9.61
9.5	$1\frac{1}{4}$	$1\frac{3}{8}$	$2\frac{27}{32}$	$1\frac{1}{4}$	$3\frac{17}{32}$	$6\frac{3}{8}$	$4\frac{31}{32}$	$9\frac{3}{4}$	$8\frac{13}{16}$	$7\frac{15}{32}$	$1\frac{3}{16}$	13.12
12	$1\frac{3}{8}$	$1\frac{1}{2}$	$3\frac{1}{8}$	$1\frac{3}{8}$	$3\frac{15}{16}$	$7\frac{3}{32}$	$5\frac{1}{2}$	$10\frac{25}{32}$	$9\frac{21}{32}$	$8\frac{9}{32}$	$1\frac{5}{16}$	17.35
16	$1\frac{1}{2}$	$1\frac{5}{8}$	$3\frac{15}{32}$	$1\frac{1}{2}$	$4\frac{3}{16}$	$8\frac{1}{2}$	$6\frac{1}{4}$	$12\frac{9}{16}$	$9\frac{3}{4}$	$9\frac{1}{4}$	$\frac{3}{4}$	27.56
25	$1\frac{3}{4}$	2	$4\frac{1}{16}$	$1\frac{25}{32}$	5	$9\frac{3}{4}$	$6\frac{7}{8}$	$14\frac{9}{16}$	$11\frac{21}{32}$	$10\frac{7}{16}$	$\frac{29}{32}$	36.82
30	2	$2\frac{1}{4}$	$4\frac{21}{32}$	$1\frac{31}{32}$	$5\frac{3}{4}$	$10\frac{3}{4}$	$8\frac{5}{32}$	$16\frac{3}{16}$	$13\frac{1}{16}$	$12\frac{3}{32}$	$1\frac{1}{32}$	55.12
55	$2\frac{1}{2}$	$2\frac{3}{4}$	$5\frac{23}{32}$	$2\frac{9}{16}$	$6\frac{1}{2}$	$12\frac{3}{8}$	$8\frac{3}{8}$	$19\frac{3}{16}$	$15\frac{5}{16}$	$13\frac{1}{2}$	$1\frac{1}{4}$	105.82
75	$3\frac{1}{4}$	$3\frac{1}{4}$	$6\frac{15}{32}$	$3\frac{9}{32}$	$7\frac{1}{4}$	13	10	$21\frac{5}{32}$	$17\frac{29}{32}$	$16\frac{17}{32}$	$1\frac{17}{32}$	169.76

CAD RFID



Green Pin BigMouth® Bow Shackle FN

Grade 8 bow shackle with safety bolt, fixed nut and wider shackle mouth

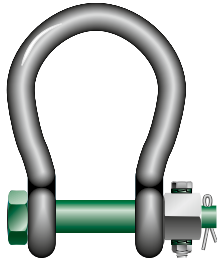

G-4243

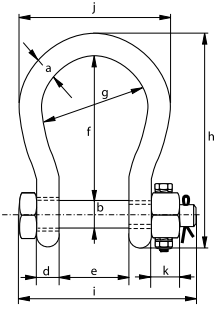

- **Material:** bow and pin alloy steel, grade 8, quenched and tempered
- **Safety Factor:** MBL equals 6 x WLL
- **Standard:** ASME B30.26
- **Finish:** hot dipped galvanized
- **Temperature range:** -20°C up to +200°C
- **Certification:** 2.1 2.2 3.1 MTC[®] CE

working load limit	diameter bow	diameter pin	diameter eye	width eye	width inside	length inside	width bow	length	length bolt	width	thickness nut	securing bolt thread	securing bolt length	torque	weight each
t	a	b	c	d	e	f	g	h	i	j	k	l	m	Nm	kg
4.75	22	25	52	22	63	112	88	173	157	132	22	M8	50	20	2.08
6.5	25	28	59	25	75	135	105	204	183	155	25	M8	55	20	3.14
8.5	28	32	66	28	82	148	115	225	205	171	27	M10	60	39	4.36
9.5	32	35	72	32	90	162	126	248	224	190	30	M10	65	39	5.95
12	35	38	79	35	100	180	140	274	245	210	33	M10	70	39	7.87
16	38	42	88	38	106	216	159	319	248	235	19	M8	75	20	12.5
25	45	50	103	45	127	248	175	370	296	265	23	M8	90	20	16.7
30	50	57	118	50	146	273	207	411	332	307	26	M10	100	39	25
55	65	70	145	65	165	314	213	487	389	343	32	M12	120	68	45
75	83	83	164	83	184	330	254	537	455	420	39	M12	140	68	77

In inch

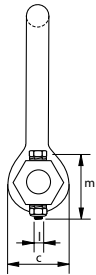

working load limit	diameter bow	diameter pin	diameter eye	width eye	width inside	length inside	width bow	length	length bolt	width	thickness nut	securing bolt thread	securing bolt length	torque	weight each
t	a	b	c	d	e	f	g	h	i	j	k	l	m	ft lb	lbs
4.75	7/8	1	2 1/16	7/8	2 15/32	4 13/32	3 15/32	6 13/16	6 3/16	5 3/16	7/8	M8	1 31/32	14.7	4.59
6.5	1	1 1/8	2 5/16	31/32	2 15/16	5 5/16	4 1/8	8 1/32	7 7/32	6 3/32	31/32	M8	2 5/32	14.7	6.92
8.5	1 1/8	1 1/4	2 19/32	1 3/32	3 7/32	5 13/16	4 17/32	8 27/32	8 1/16	6 23/32	1 1/16	M10	2 3/8	28.7	9.61
9.5	1 1/4	1 3/8	2 27/32	1 1/4	3 17/32	6 3/8	4 31/32	9 3/4	8 13/16	7 15/32	1 3/16	M10	2 9/16	28.7	13.12
12	1 3/8	1 1/2	3 1/8	1 3/8	3 15/16	7 3/32	5 1/2	10 25/32	9 21/32	8 9/32	1 5/16	M10	2 3/4	28.7	17.35
16	1 1/2	1 5/8	3 15/32	1 1/2	4 3/16	8 1/2	6 1/4	12 9/16	9 3/4	9 1/4	3/4	M8	2 15/16	14.7	27.56
25	1 3/4	2	4 1/16	1 25/32	5	9 3/4	6 7/8	14 9/16	11 21/32	10 7/16	29/32	M8	3 17/32	14.7	36.82
30	2	2 1/4	4 21/32	1 31/32	5 3/4	10 3/4	8 5/32	16 3/16	13 1/16	12 3/32	1 1/32	M10	3 15/16	28.7	55.12
55	2 1/2	2 3/4	5 23/32	2 9/16	6 1/2	12 3/8	8 3/8	19 3/16	15 5/16	13 1/2	1 1/4	M12	4 23/32	50.1	105.82
75	3 1/4	3 1/4	6 15/32	3 9/32	7 1/4	13	10	21 5/32	17 15/16	16 17/32	1 17/32	M12	5 1/2	50.1	169.76



Green Pin BigMouth® Dee Shackle BN

Dee shackle with a longer inside length, wider mouth and safety bolt

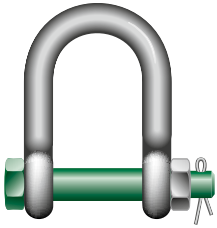

G-4553

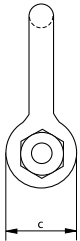
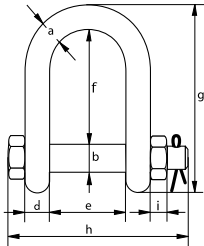

- **Material:** bow and pin alloy steel, grade 8, quenched and tempered
- **Safety Factor:** MBL equals 5 x WLL
- **Standard:** ASME B30.26
- **Finish:** hot dipped galvanized
- **Temperature Range:** -20°C up to +200°C
- **Certification:** 2.1 2.2 3.1 MTC^a CE

working load limit	diameter bow	diameter pin	diameter eye	width eye	width inside	length inside	length	length bolt	thickness nut	weight each
t	a	b	c	d	e	f	g	h	i	kg
4.6	19	22	46	19	70	116	169	154	19	1.50
8.6	25	28	59	25	83	140	208	190	25	3.15
15.5	38	42	88	38	115	178	281	257	19	9.50

In inch

working load limit	diameter bow	diameter pin	diameter eye	width eye	width inside	length inside	length	length bolt	thickness nut	weight each
t	a	b	c	d	e	f	g	h	i	lbs
4.6	$\frac{3}{4}$	$\frac{7}{8}$	$1 \frac{15}{16}$	$\frac{3}{4}$	$2 \frac{3}{4}$	$4 \frac{9}{16}$	$6 \frac{21}{32}$	$6 \frac{1}{16}$	$\frac{3}{4}$	3.30
8.6	1	$1 \frac{1}{8}$	$1 \frac{5}{16}$	1	$3 \frac{1}{4}$	$5 \frac{1}{2}$	$8 \frac{3}{16}$	$7 \frac{15}{32}$	1	6.90
15.5	$1 \frac{1}{2}$	$1 \frac{5}{8}$	$1 \frac{15}{32}$	$1 \frac{1}{2}$	$4 \frac{9}{16}$	7	$11 \frac{1}{16}$	$10 \frac{1}{8}$	$\frac{3}{4}$	20.94



Green Pin® Spring Pin ROV Shackle

Release ROV shackle (grade 8) with spring pins

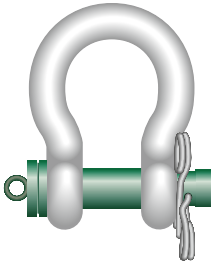

P-5363

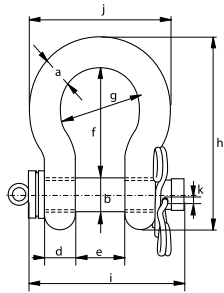

- **Material:** bow and pin alloy steel, grade 8, Polar quality, quenched and tempered
- **Safety factor:** MBL equals 5 x WLL
- **Finish:** body painted white, pin painted green
- **Temperature Range:** -60°C up to +200°C
- **Certification:** 2.1 2.2 3.1 MTC³ CE
- **Note:** for in-line use only.
supplied without wires; design your own wiring plan

working load limit	diameter bow	diameter pin	diameter eye	width eye	width inside	length inside	width bow	length	length bolt	width	diameter	weight each
t	a mm	b mm	c mm	d mm	e mm	f mm	g mm	h mm	i mm	j mm	k mm	kg
6.5	22	25	52	22	36	83	58	144	130	102	5.5	1.7
9.5	28	32	66	28	47	108	75	185	166	131	6.5	3.4
12	32	35	72	32	51	115	83	201	184	147	6.5	4.7
17	38	42	88	38	60	146	99	249	202	175	6.5	8
25	45	50	103	45	74	178	126	300	243	216	8.5	13.6
35	50	57	116	50	83	197	138	334	269	238	8.5	19.1
42.5	57	65	130	57	95	222	160	377	301	274	8.5	28.3
55	65	70	145	65	105	260	180	433	329	310	8.5	38
85	75	83	162	75	127	329	190	527	375	340	8.5	60

In inch

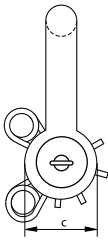

working load limit	diameter bow	diameter pin	diameter eye	width eye	width inside	length inside	width bow	length	length bolt	width	diameter	weight each
t	a inch	b inch	c inch	d inch	e inch	f inch	g inch	h inch	i inch	j inch	k inch	lbs
6.5	7/8	1	2 1/32	7/8	1 7/16	3 9/32	2 9/32	5 11/16	5 1/8	4	7/32	3.75
9.5	1 1/8	1 1/4	2 19/32	1 1/8	1 7/8	4 1/4	2 15/16	7 9/32	6 17/32	5 5/32	1/4	7.5
12	1 1/4	1 3/8	2 13/16	1 9/32	2	4 17/32	3 9/32	7 29/32	7 1/4	5 25/32	1/4	10.36
17	1 1/2	1 5/8	3 1/2	1 17/32	2 11/32	5 3/4	3 29/32	9 13/16	7 15/16	6 7/8	1/4	17.64
25	1 3/4	2	4 1/32	1 25/32	2 29/32	7	4 15/16	11 13/16	9 19/32	8 17/32	11/32	30.0
35	2	2 1/4	4 9/16	1 31/32	3 9/32	7 3/4	5 7/16	13 5/32	10 19/32	9 3/8	11/32	42.1
42.5	2 1/4	2 9/16	5 1/8	2 1/4	3 3/4	8 3/4	6 9/32	14 13/16	11 7/8	10 25/32	11/32	62.4
55	2 1/2	2 3/4	5 23/32	2 9/16	4 1/8	10 1/4	7 3/32	17 3/32	12 15/16	12 3/16	11/32	83.8
85	3	3 1/4	6 11/32	2 15/16	5	12 15/16	7 1/2	20 3/4	14 3/4	13 3/8	11/32	132.3

CAD RFID



Green Pin® Locking Clamp ROV Shackle

Release ROV shackle (grade 8) with locking clamp

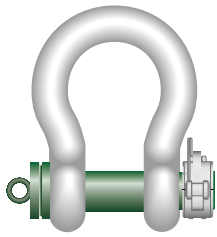

P-5365

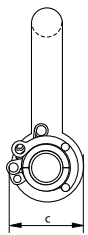
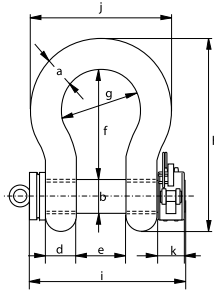

- **Material:** bow and pin alloy steel, grade 8, Polar quality, quenched and tempered
- **Safety Factor:** MBL equals 6 x WLL
for shackles with WLL 120 t and up the MBL equals 5x WLL
- **Finish:** body painted white, pin painted green
- **Temperature Range:** -60°C up to +200°C
- **Certification:** 2.1 2.2 3.1 MTC^a MTC^b * LROS * CE
- **Note:** supplied without wires; design your own wiring plan

working load limit	diameter bow	diameter pin	diameter eye	width eye	width inside	length inside	width bow	length	length bolt	width	width locking clamp	weight each
t	a mm	b mm	c mm	d mm	e mm	f mm	g mm	h mm	i mm	j mm	k mm	kg
6.5	22	25	52	22	36	83	58	164	131	102	31	2.27
9.5	28	32	66	28	47	108	75	200	166	131	31	4.25
12	32	35	72	32	51	115	83	213	184	147	31	5.36
17	38	42	88	38	60	146	99	266	206	175	40	9.27
25	45	50	103	45	74	178	126	309	243	216	40	14.62
35	50	57	116	50	83	197	138	350	269	238	40	20.75
42.5	57	65	130	57	95	222	160	377	301	274	40	28.33
55	65	70	145	65	105	260	180	440	329	310	40	41
85	75	83	162	75	127	329	190	527	375	340	40	61
120	95	95	208	91	147	400	238	647	440	428	60	110
150	105	108	238	102	169	410	275	688	490	485	60	160
200	120	130	279	113	179	513	290	838	520	530	60	235
250	130	140	299	118	205	554	305	904	560	565	60	285

In inch

working load limit	diameter bow	diameter pin	diameter eye	width eye	width inside	length inside	width bow	length	length bolt	width	width locking clamp	weight each
t	a inch	b inch	c inch	d inch	e inch	f inch	g inch	h inch	i inch	j inch	k inch	lbs
6.5	7/8	1	2 1/32	7/8	1 7/16	3 9/32	2 9/32	6 7/16	5 5/32	4	1 7/32	5.00
9.5	1 1/8	1 1/4	2 19/32	1 1/8	1 7/8	4 1/4	2 15/16	7 7/8	6 17/32	5 5/32	1 7/32	9.37
12	1 1/4	1 3/8	2 13/16	1 9/32	2	4 17/32	3 9/32	8 3/8	7 1/4	5 25/32	1 7/32	11.82
17	1 1/2	1 5/8	3 1/2	1 17/32	2 11/32	5 3/4	3 29/32	10 1/2	8 1/8	6 7/8	1 9/16	20.44
25	1 3/4	2	4 1/32	1 25/32	2 29/32	7	4 15/16	12 5/32	9 19/32	8 17/32	1 9/16	32.23
35	2	2 1/4	4 9/16	1 31/32	3 9/32	7 3/4	5 7/16	13 25/32	10 19/32	9 3/8	1 9/16	45.75
42.5	2 1/4	2 9/16	5 1/8	2 1/4	3 3/4	8 3/4	6 9/32	14 13/16	11 7/8	10 25/32	1 9/16	62.5
55	2 1/2	2 3/4	5 23/32	2 9/16	4 1/8	10 1/4	7 3/32	17 11/32	12 15/16	12 3/16	1 9/16	90.4
85	3	3 1/4	6 11/32	2 15/16	5	12 15/16	7 1/2	20 3/4	14 3/4	13 3/8	1 9/16	134.5
120	3 3/4	3 3/4	8 3/16	3 19/32	5 25/32	15 3/4	9 3/8	25 1/2	17 11/32	16 7/8	2 11/32	243
150	4 1/8	4 1/4	9 3/8	4	6 5/8	16 5/32	10 13/16	27 3/32	19 5/16	19 1/8	2 11/32	353
200	4 23/32	5 1/8	11	4 7/16	7 1/32	20 3/16	11 7/16	33	20 1/2	20 7/8	2 11/32	518
250	5 1/8	5 1/2	11 25/32	4 5/8	8 3/32	21 13/16	12	35 19/32	22 1/32	22 1/4	2 11/32	628

CAD RFID

* For shackles ≥ WLL 150 t



Green Pin® Spring Release ROV Shackle

Release ROV shackle (grade 8) with spring

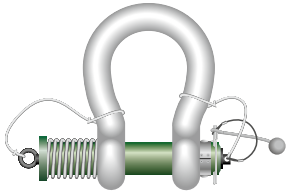

- **Material:** bow and pin alloy steel, grade 8, Polar quality, quenched and tempered
- **Safety factor:** MBL equals 5 x WLL
- **Finish:** body painted white, pin painted green
- **Temperature Range:** -40°C up to +200°C
- **Certification:** 2.1 2.2 3.1 MTC^a LROS^{*} CE
- **Note:** for in-line use only.
this shackle is assembled with wire rope slings and monkey's fist for size starting from WLL 42.5 up to and including 150 t a special compression tool (sold separately) is required to assemble the shackle.

P-5367

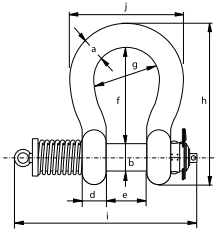

working load limit	diameter bow	diameter pin	diameter eye	width eye	width inside	length inside	width bow	length	length bolt	width	weight each
t	a mm	b mm	c mm	d mm	e mm	f mm	g mm	h mm	i mm	j mm	kg
12	32	35	72	32	51	115	83	201	291	147	5.24
13.5	35	38	80	35	57	133	92	227	301	162	7
17	38	42	88	38	60	146	99	249	360	175	9.25
25	45	50	103	45	74	178	126	300	370	216	15.5
35	50	57	116	50	83	197	138	334	400	238	20.4
42.5	57	65	130	57	95	222	160	377	460	274	39
55	65	70	145	65	105	260	180	433	490	310	42
85	75	83	162	75	127	329	190	527	587	340	67
120	95	95	208	91	147	399	238	646	687	428	123
150	105	108	238	102	169	410	275	688	727	485	168

In inch

working load limit	diameter bow	diameter pin	diameter eye	width eye	width inside	length inside	width bow	length	length bolt	width	weight each
t	a inch	b inch	c inch	d inch	e inch	f inch	g inch	h inch	i inch	j inch	lbs
12	1 1/4	1 3/8	2 13/16	1 9/32	2	4 17/32	3 9/32	7 29/32	11 1/2	5 25/32	11.55
13.5	1 3/8	1 1/2	3 5/32	1 3/8	2 1/4	5 1/4	3 5/8	8 15/16	11 7/8	6 11/32	15.43
17	1 1/2	1 5/8	3 1/2	1 17/32	2 11/32	5 3/4	3 29/32	9 13/16	14 5/32	6 7/8	20.39
25	1 3/4	2	4 1/32	1 25/32	2 29/32	7	4 15/16	11 13/16	14 9/16	8 17/32	34.2
35	2	2 1/4	4 9/16	1 31/32	3 9/32	7 3/4	5 7/16	13 5/32	15 3/4	9 3/8	45
42.5	2 1/4	2 9/16	5 1/8	2 1/4	3 3/4	8 3/4	6 9/32	14 13/16	18 1/8	10 25/32	86
55	2 1/2	2 3/4	5 23/32	2 9/16	4 1/8	10 1/4	7 3/32	17 3/32	19 5/16	12 3/16	92.6
85	3	3 1/4	6 11/32	2 15/16	5	12 15/16	7 1/2	20 3/4	23 1/8	13 3/8	147.7
120	3 3/4	3 3/4	8 3/16	3 19/32	5 25/32	15 23/32	9 3/8	25 7/16	27 1/32	16 7/8	271
150	4 1/8	4 1/4	9 3/8	4	6 5/8	16 5/32	10 13/16	27 3/32	28 19/32	19 1/8	370

CAD RFID

* For shackles ≥ WLL 150 t



Green Pin® Compression Tool

Tool to wind up spring release shackle (sizes WLL 42.5T and up)



P-5368

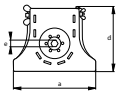
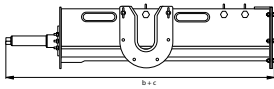

- **Material:** mild steel
- **Finish:** black painted
- **Note:** required for ROV spring release shackle (type P-5367), for sizes WLL 42.5 t and up
- **Certification:** 2.1

for shackle WLL	diameter bow	diameter pin	width	length closed position	length opened position	height	width	weight each
t	a mm	b mm	a mm	b mm	c mm	d mm	e mm	kg
42.5	57	65	300	1000	1500	225	24	34
55	65	70						
85	75	83						
120	95	95	340	1100	1750	285	24	42
150	105	108						

In inch

for shackle WLL	diameter bow	diameter pin	width	length closed position	length opened position	height	width	weight each
t	a inch	b inch	a inch	b inch	c inch	d inch	e inch	lbs
42.5	2 1/4	2 9/16	11 13/16	39 3/8	59 1/16	8 7/8	15/16	75
55	2 1/2	2 3/4						
85	3	3 1/4						
120	3 3/4	3 3/4	13 3/8	43 5/16	68 29/32	11 1/4	15/16	92.6
150	4 1/8	4 1/4						



Green Pin® Tapered Pin ROV Shackle D

Release & retrieve ROV shackle (grade 8) with tapered pin and D-handle

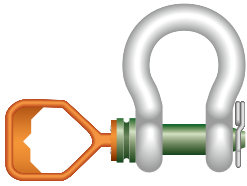

P-5361D

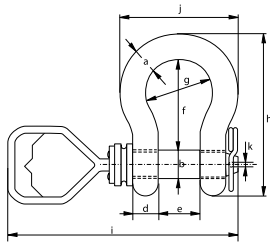

- **Material:** bow and pin alloy steel, grade 8, polar quality, quenched and tempered
- **Safety factor:** MBL equals 5 x WLL
- **Finish:** body painted white, pin painted green
- **Temperature Range:** -60°C up to +200°C
- **Certification:** 2.1 2.2 3.1 MTC^a CE
- **Note:** supplied without wires; design your own wiring plan

working load limit	diameter bow	diameter pin	diameter eye	width eye	width inside	length inside	width bow	length	length bolt	width	diameter clamp	weight each
t	a mm	b mm	c mm	d mm	e mm	f mm	g mm	h mm	i mm	j mm	k mm	kg
6.5	22	25	52	22	36	83	58	144	345	102	3.5	1.50
9.5	28	32	66	28	47	108	75	185	381	131	5.5	3.16
12	32	35	72	32	51	115	83	201	393	147	6.5	4.31
17	38	42	88	38	60	146	99	249	417	175	8.5	7.43
25	45	50	103	45	74	178	126	300	464	216	8.5	12.84
35	50	57	111	50	83	197	138	331	484	238	8.5	18.15
42.5	57	65	130	57	95	222	160	377	516	274	7.5	26.29
55	65	70	145	65	105	260	180	433	545	310	7.5	37.60

In inch

working load limit	diameter bow	diameter pin	diameter eye	width eye	width inside	length inside	width bow	length	length bolt	width	diameter clamp	weight each
t	a inch	b inch	c inch	d inch	e inch	f inch	g inch	h inch	i inch	j inch	k inch	lbs
6.5	7/8	1	2 1/16	7/8	1 7/16	3 9/32	2 9/32	5 21/32	13 19/32	4 1/32	1/8	3.31
9.5	1 1/8	1 1/4	2 19/32	1 1/8	1 7/8	4 1/4	2 15/16	7 9/32	15	5 5/32	7/32	6.97
12	1 1/4	1 3/8	2 27/32	1 9/32	2	4 17/32	3 9/32	7 29/32	15 15/32	5 25/32	1/4	9.49
17	1 1/2	1 5/8	3 15/32	1 17/32	2 11/32	5 3/4	3 29/32	9 13/16	16 13/32	6 7/8	11/32	16.37
25	1 3/4	2	4 1/16	1 25/32	2 29/32	7	4 15/16	11 13/16	18 9/32	8 1/2	11/32	28.31
35	2	2 1/4	4 3/8	1 31/32	3 9/32	7 3/4	5 7/16	13 1/32	19 1/16	9 3/8	11/32	40.01
42.5	2 1/4	2 9/16	5 1/8	2 1/4	3 3/4	8 3/4	6 9/32	14 27/32	20 5/16	10 25/32	9/32	57.96
55	2 1/2	2 3/4	5 23/32	2 9/16	4 1/8	10 1/4	7 9/32	17 1/16	21 15/32	12 7/32	9/32	82.89

INFO



Green Pin® Tapered Pin ROV Shackle F

Release & retrieve ROV shackle (grade 8) with tapered screw pin and Fishtail handle

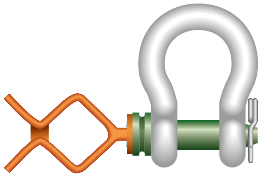

- **Material:** bow and pin alloy steel, grade 8, polar quality, quenched and tempered
- **Safety factor:** MBL equals 5 x WLL
- **Finish:** body painted white, pin painted green
- **Temperature Range:** -60°C up to +200°C
- **Certification:** 2.1 2.2 3.1 MTC® CE
- **Note:** supplied without wires; design your own wiring plan

P-5361F

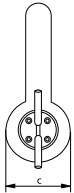
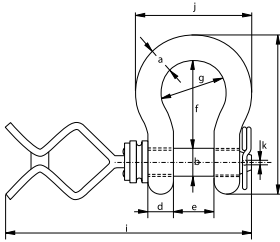

working load limit	diameter bow	diameter pin	diameter eye	width eye	width inside	length inside	width bow	length	length bolt	width	diameter	weight each
t	a mm	b mm	c mm	d mm	e mm	f mm	g mm	h mm	i mm	j mm	k mm	kg
6.5	22	25	52	22	36	83	58	144	419	102	3.5	1.50
9.5	28	32	66	28	47	108	75	185	455	131	5.5	3.16
12	32	35	72	32	51	115	83	201	467	147	6.5	4.31
17	38	42	88	38	60	146	99	249	491	175	8.5	7.43
25	45	50	103	45	74	178	126	300	538	216	8.5	12.84
35	50	57	111	50	83	197	138	331	558	238	8.5	18.15
42.5	57	65	130	57	95	222	160	377	590	274	7.5	26.29
55	65	70	145	65	105	260	180	433	619	310	7.5	37.60

In inch

working load limit	diameter bow	diameter pin	diameter eye	width eye	width inside	length inside	width bow	length	length bolt	width	diameter	weight each
t	a inch	b inch	c inch	d inch	e inch	f inch	g inch	h inch	i inch	j inch	k inch	lbs
6.5	$\frac{7}{8}$	1	$2\frac{1}{16}$	$\frac{7}{8}$	$1\frac{7}{16}$	$3\frac{9}{32}$	$2\frac{9}{32}$	$5\frac{21}{32}$	$16\frac{1}{2}$	$4\frac{1}{32}$	$\frac{1}{8}$	3.31
9.5	$1\frac{1}{8}$	$1\frac{1}{4}$	$2\frac{19}{32}$	$1\frac{1}{8}$	$1\frac{7}{8}$	$4\frac{1}{4}$	$2\frac{15}{16}$	$7\frac{9}{32}$	$17\frac{29}{32}$	$5\frac{5}{32}$	$\frac{7}{32}$	6.97
12	$1\frac{1}{4}$	$1\frac{3}{8}$	$2\frac{27}{32}$	$1\frac{9}{32}$	2	$4\frac{17}{32}$	$3\frac{9}{32}$	$7\frac{29}{32}$	$18\frac{3}{8}$	$5\frac{25}{32}$	$\frac{1}{4}$	9.49
17	$1\frac{1}{2}$	$1\frac{5}{8}$	$3\frac{15}{32}$	$1\frac{17}{32}$	$2\frac{11}{32}$	$5\frac{3}{4}$	$3\frac{29}{32}$	$9\frac{13}{16}$	$19\frac{11}{32}$	$6\frac{7}{8}$	$\frac{11}{32}$	16.37
25	$1\frac{3}{4}$	2	$4\frac{1}{16}$	$1\frac{25}{32}$	$2\frac{29}{32}$	7	$4\frac{15}{16}$	$11\frac{13}{16}$	$21\frac{3}{16}$	$8\frac{1}{2}$	$\frac{11}{32}$	28.31
35	2	$2\frac{1}{4}$	$4\frac{3}{8}$	$1\frac{31}{32}$	$3\frac{9}{32}$	$7\frac{3}{4}$	$5\frac{7}{16}$	$13\frac{1}{32}$	$21\frac{31}{32}$	$9\frac{3}{8}$	$\frac{11}{32}$	40.01
42.5	$2\frac{1}{4}$	$2\frac{9}{16}$	$5\frac{1}{8}$	$2\frac{1}{4}$	$3\frac{3}{4}$	$8\frac{3}{4}$	$6\frac{9}{32}$	$14\frac{27}{32}$	$23\frac{7}{32}$	$10\frac{25}{32}$	$\frac{9}{32}$	57.96
55	$2\frac{1}{2}$	$2\frac{3}{4}$	$5\frac{23}{32}$	$2\frac{9}{16}$	$4\frac{1}{8}$	$10\frac{1}{4}$	$7\frac{9}{32}$	$17\frac{1}{16}$	$24\frac{3}{8}$	$12\frac{7}{32}$	$\frac{9}{32}$	82.89

INFO



Green Pin® Guided Pin ROV Shackle D

Release & retrieve ROV shackle (grade 8) with guiding tube and D-handle

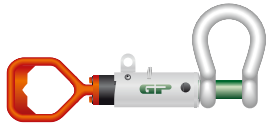

- **Material:** shackle body and pin alloy steel, grade 8, polar quality, quenched and tempered
- **Safety factor:** MBL equals 5 x WLL
- **Finish:** body painted white, pin painted green
- **Temperature Range:** -60°C up to +200°C
- **Certification:** 2.1 2.2 3.1 MTC^a CE

P-5362D

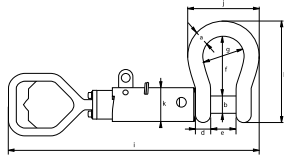

working load limit	diameter bow	diameter pin	diameter eye	width eye	width inside	length inside	width bow	length	length bolt		width	guide diameter	weight each
	a	b	c	d	e	f	g	h	close	open			
t	mm	mm	mm	mm	mm	mm	mm	mm	i		j	k	kg
12	32	35	72	32	51	115	83	201	569	652	147	83	10
17	38	42	88	38	60	146	99	249	612	710	175	83	14
25	45	50	103	45	74	178	126	300	683	802	216	83	19
35	50	57	111	50	83	197	138	331	711	844	238	83	24
42.5	57	65	130	57	95	222	160	377	785	937	274	102	34
55	65	70	145	65	105	260	180	433	824	994	310	102	45



In inch

working load limit	diameter bow	diameter pin	diameter eye	width eye	width inside	length inside	width bow	length	length bolt		width	guide diameter	weight each
	a	b	c	d	e	f	g	h	close	open			
t	inch	inch	inch	inch	inch	inch	inch	inch	i		j	k	lbs
12	1 1/4	1 3/8	2 27/32	1 1/4	2	4 17/32	3 9/32	7 29/32	22 13/32	25 21/32	5 25/32	3 9/32	22
17	1 1/2	1 5/8	3 15/32	1 1/2	2 3/8	5 3/4	3 29/32	9 13/16	24 3/32	27 15/16	6 7/8	3 9/32	31
25	1 3/4	2	4 1/16	1 25/32	2 29/32	7	4 31/32	11 13/16	26 7/8	31 9/16	8 1/2	3 9/32	42
35	2	2 1/4	4 3/8	1 31/32	3 9/32	7 3/4	5 7/16	13 1/32	28	33 7/32	9 3/8	3 9/32	53
42.5	2 1/4	2 9/16	5 1/8	2 1/4	3 3/4	8 3/4	6 5/16	14 27/32	30 29/32	36 7/8	10 25/32	4 1/32	75
55	2 1/2	2 3/4	5 23/32	2 9/16	4 1/8	10 1/4	7 3/32	17 1/16	32 7/16	39 1/8	12 7/32	4 1/32	99

INFO



Green Pin® Guided Pin ROV Shackle F

Release & retrieve ROV shackle (grade 8) with guiding tube and Fishtail handle

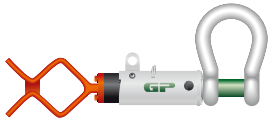

- **Material:** shackle body and pin alloy steel, grade 8, polar quality, quenched and tempered
- **Safety factor:** MBL equals 5 x WLL
- **Finish:** body painted white, pin painted green
- **Temperature Range:** -60°C up to +200°C
- **Certification:** 2.1 2.2 3.1 MTC[®] CE

P-5362F

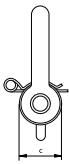
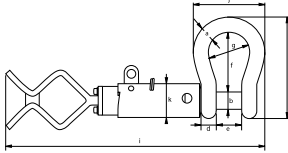

working load limit	diameter bow	diameter pin	diameter eye	width eye	width inside	length inside	width bow	length	length bolt		width	guide diameter	weight each
									close	open			
t	a	b	c	d	e	f	g	h	i		j	k	kg
12	32	35	72	32	51	115	83	201	643	726	147	83	10
17	38	42	88	38	60	146	99	249	686	784	175	83	14
25	45	50	103	45	74	178	126	300	757	876	216	83	19
35	50	57	111	50	83	197	138	331	785	918	238	83	24
42.5	57	65	130	57	95	222	160	377	859	1011	274	102	34
55	65	70	145	65	105	260	180	433	898	1068	310	102	45

In inch

working load limit	diameter bow	diameter pin	diameter eye	width eye	width inside	length inside	width bow	length	length bolt		width	guide diameter	weight each
									close	open			
t	a	b	c	d	e	f	g	h	i		j	k	lbs
12	1 1/4	1 3/8	2 27/32	1 1/4	2	4 17/32	3 9/32	7 29/32	25 5/16	28 19/32	5 25/32	3 9/32	22
17	1 1/2	1 5/8	3 15/32	1 1/2	2 3/8	5 3/4	3 29/32	9 13/16	27	30 7/8	6 7/8	3 9/32	31
25	1 3/4	2	4 1/16	1 25/32	2 29/32	7	4 31/32	11 13/16	29 13/16	34 1/2	8 1/2	3 9/32	42
35	2	2 1/4	4 3/8	1 31/32	3 9/32	7 3/4	5 7/16	13 1/32	30 29/32	36 5/32	9 3/8	3 9/32	53
42.5	2 1/4	2 9/16	5 1/8	2 1/4	3 3/4	8 3/4	6 5/16	14 27/32	33 13/16	39 13/16	10 25/32	4 1/32	75
55	2 1/2	2 3/4	5 23/32	2 9/16	4 1/8	10 1/4	7 3/32	17 1/16	35 11/32	42 1/16	12 7/32	4 1/32	99

INFO



Green Pin® D-handle

Accessory for Green Pin® ROV Shackle

- **Material:** cast steel
- **Finish:** painted orange
- **Certification:** 2.1



diameter	width	length	width	length inside	thickness	diameter	diameter	diameter	weight each
a	b	c	d	e	f	g	h	i	kg
19	153	215	115	110	10	70	48	8.5	1.70

In inch

diameter	width	length	width	length inside	thickness	diameter	diameter	diameter	weight each
a	b	c	d	e	f	g	h	i	lbs
$\frac{3}{4}$	$6 \frac{1}{32}$	$8 \frac{15}{32}$	$4 \frac{17}{32}$	$4 \frac{11}{32}$	$\frac{13}{32}$	$2 \frac{3}{4}$	$1 \frac{7}{8}$	$\frac{11}{32}$	3.75

P-5396D

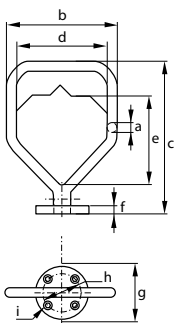

Green Pin® Fishtail handle

Accessory for Green Pin® ROV Shackle

- **Material:** cast steel
- **Finish:** painted orange
- **Certification:** 2.1

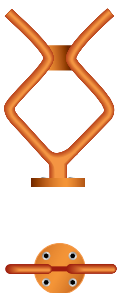

diameter	width	length	width	length inside	thickness	diameter	diameter	diameter	weight each
a	b	c	d	e	f	g	h	i	kg
19	178	289	21	133	10	70	48	8.5	1.92

In inch

diameter	width	length	width	length inside	thickness	diameter	diameter	diameter	weight each
a	b	c	d	e	f	g	h	i	lbs
$\frac{3}{4}$	7	$11 \frac{3}{8}$	$\frac{13}{16}$	$5 \frac{1}{4}$	$\frac{13}{32}$	$2 \frac{3}{4}$	$1 \frac{7}{8}$	$\frac{11}{32}$	4.23

P-5396F

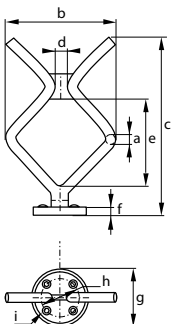



Green Pin® Web Sling Shackle SC

Shackle for synthetic web slings with screw collar pin



P-5461

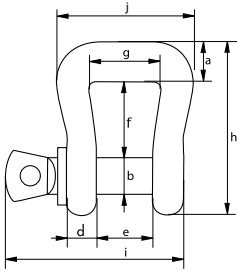

- **Material:** bow and pin alloy steel, grade 8, quenched and tempered
- **Safety Factor:** MBL equals 6 x WLL
- **Standard:** ASME B30.26
- **Finish:** painted green
- **Temperature Range:** -40°C up to 200°C
- **Certification:** 2.1 2.2 3.1 CE

working load limit	diameter bow	diameter pin	diameter eye	width eye	width inside	length inside	width inside	length	length bolt	width	weight each
t	a mm	b mm	c mm	d mm	e mm	f mm	g mm	h mm	i mm	j mm	kg
3.25	20	19	40	16	27	38	35	87	89	68	0.66
4.75	24	22	46	19	31	48	46	106	103	85	1.1
6.5	27	25	52	22	36	72	62	137	119	109	1.79
8.5	31	28	59	25	43	84	79	158	137	134	2.79

In inch

working load limit	diameter bow	diameter pin	diameter eye	width eye	width inside	length inside	width inside	length	length bolt	width	weight each
t	a inch	b inch	c inch	d inch	e inch	f inch	g inch	h inch	i inch	j inch	lbs
3.25	$\frac{25}{32}$	$\frac{3}{4}$	$1 \frac{9}{16}$	$\frac{5}{8}$	$1 \frac{1}{16}$	$1 \frac{1}{2}$	$1 \frac{3}{8}$	$3 \frac{7}{16}$	$3 \frac{1}{2}$	$2 \frac{11}{16}$	1.46
4.75	$\frac{15}{16}$	$\frac{7}{8}$	$1 \frac{13}{16}$	$\frac{3}{4}$	$1 \frac{7}{32}$	$1 \frac{7}{8}$	$1 \frac{13}{16}$	$4 \frac{3}{16}$	$4 \frac{1}{16}$	$3 \frac{11}{32}$	2.42
6.5	$1 \frac{1}{16}$	1	$2 \frac{1}{16}$	$\frac{7}{8}$	$1 \frac{13}{32}$	$2 \frac{27}{32}$	$2 \frac{7}{16}$	$5 \frac{13}{32}$	$4 \frac{11}{16}$	$4 \frac{9}{32}$	3.95
8.5	$1 \frac{7}{32}$	$1 \frac{1}{8}$	$2 \frac{5}{16}$	$\frac{31}{32}$	$1 \frac{11}{16}$	$3 \frac{5}{16}$	$3 \frac{1}{8}$	$6 \frac{7}{32}$	$5 \frac{13}{32}$	$5 \frac{9}{32}$	6.04



Green Pin® Theatre Shackle SC

Matte black bow shackle with screw collar pin



P-4161T

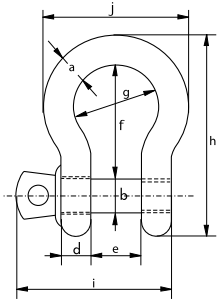

- **Material:** bow and pin high tensile steel, grade 6, quenched and tempered
- **Safety Factor:** MBL equals 6 x WLL
- **Standard:** EN 13889 and meets performance requirements of US Fed. Spec. RR-C-271 Type IVA Class 2, grade A, from 2 t and upward these shackles comply with ASME B30.26
- **Finish:** black
- **Temperature Range:** -40°C up to +200°C
- **Certification:** 2.1 2.2 3.1 MTC^a CE

working load limit	diameter bow	diameter pin	diameter eye	width eye	width inside	length inside	width bow	length	length bolt	width	weight each
t	a mm	b mm	c mm	d mm	e mm	f mm	g mm	h mm	i mm	j mm	kg
0.33	5	6	12	5	9.5	22	16	36	29.5	26	0.02
0.5	7	8	16.5	7	12	29	20	48.5	38	34	0.05
0.75	9	10	20	9	13.5	32	22	56	46.5	40	0.1
1	10	11	22.5	10	17	36.5	26	63.5	54	46	0.14
1.5	11	13	26.5	11	19	43	29	74	59.5	51	0.19
2	13.5	16	34	13	22	51	32	89	73	58	0.36
3.25	16	19	40	16	27	64	43	110	89	75	0.63
4.75	19	22	46	19	31	76	51	129	103	89	1.01
6.5	22	25	52	22	36	83	58	144	119	102	1.5
8.5	25	28	59	25	43	95	68	164	137	118	2.21

In inch

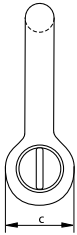

working load limit	diameter bow	diameter pin	diameter eye	width eye	width inside	length inside	width bow	length	length bolt	width	weight each
t	a inch	b inch	c inch	d inch	e inch	f inch	g inch	h inch	i inch	j inch	lbs
0.33	$\frac{3}{16}$	$\frac{1}{4}$	$\frac{1}{2}$	$\frac{3}{16}$	$\frac{3}{8}$	$\frac{7}{8}$	$\frac{5}{8}$	$1\frac{13}{32}$	$1\frac{5}{32}$	$1\frac{1}{32}$	0.05
0.5	$\frac{1}{4}$	$\frac{5}{16}$	$\frac{21}{32}$	$\frac{9}{32}$	$\frac{15}{32}$	$1\frac{5}{32}$	$\frac{25}{32}$	$1\frac{29}{32}$	$1\frac{1}{2}$	$1\frac{11}{32}$	0.11
0.75	$\frac{5}{16}$	$\frac{3}{8}$	$\frac{25}{32}$	$\frac{11}{32}$	$\frac{17}{32}$	$1\frac{1}{4}$	$\frac{7}{8}$	$2\frac{7}{32}$	$1\frac{27}{32}$	$1\frac{9}{16}$	0.22
1	$\frac{3}{8}$	$\frac{7}{16}$	$\frac{7}{8}$	$\frac{13}{32}$	$\frac{21}{32}$	$1\frac{7}{16}$	$1\frac{1}{32}$	$2\frac{1}{2}$	$2\frac{1}{8}$	$1\frac{13}{16}$	0.3
1.5	$\frac{7}{16}$	$\frac{1}{2}$	$1\frac{1}{32}$	$\frac{7}{16}$	$\frac{3}{4}$	$1\frac{11}{16}$	$1\frac{5}{32}$	$2\frac{29}{32}$	$2\frac{11}{32}$	2	0.42
2	$\frac{1}{2}$	$\frac{5}{8}$	$1\frac{11}{32}$	$\frac{1}{2}$	$\frac{7}{8}$	2	$1\frac{1}{4}$	$3\frac{1}{2}$	$2\frac{7}{8}$	$2\frac{9}{32}$	0.79
3.25	$\frac{5}{8}$	$\frac{3}{4}$	$1\frac{9}{16}$	$\frac{5}{8}$	$1\frac{1}{16}$	$2\frac{17}{32}$	$1\frac{11}{16}$	$4\frac{11}{32}$	$3\frac{1}{2}$	$2\frac{15}{16}$	1.38
4.75	$\frac{3}{4}$	$\frac{7}{8}$	$1\frac{13}{16}$	$\frac{3}{4}$	$1\frac{7}{32}$	3	2	$5\frac{3}{32}$	$4\frac{1}{16}$	$3\frac{1}{2}$	2.22
6.5	$\frac{7}{8}$	1	$2\frac{1}{16}$	$\frac{7}{8}$	$1\frac{13}{32}$	$3\frac{9}{32}$	$2\frac{9}{32}$	$5\frac{21}{32}$	$4\frac{11}{16}$	$4\frac{1}{32}$	3.31
8.5	1	$1\frac{1}{8}$	$2\frac{5}{16}$	$\frac{31}{32}$	$1\frac{11}{16}$	$3\frac{3}{4}$	$2\frac{11}{16}$	$6\frac{15}{32}$	$5\frac{13}{32}$	$4\frac{21}{32}$	4.86



Green Pin® Fishing Bow Shackle SQ

Bow shackle with square headed screw pin

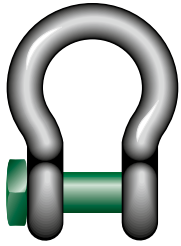

G-4164

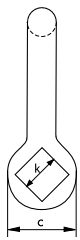
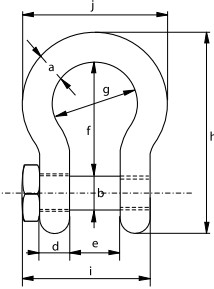

- **Material:** bow and pin high tensile steel, grade 6, quenched and tempered
- **Safety Factor:** MBL equals 6 x WLL
- **Standard:** EN 13889, ASME B30.26 and meets performance requirements of US Fed. Spec. RR-C-271, grade A
- **Finish:** hot dipped galvanized
- **Certification:** 2.1 2.2 3.1 MTC[®] CE

working load limit	diameter bow	diameter pin	diameter eye	width eye	width inside	length inside	width bow	length	length bolt	width	width bolt head	weight each
t	a mm	b mm	c mm	d mm	e mm	f mm	g mm	h mm	i mm	j mm	k mm	kg
2	13.5	16	34	13	22	51	32	89	57.5	58	22	0.34
3.25	16	19	40	16	27	64	43	110	71	75	27	0.63
4.75	19	22	46	19	31	76	51	129	82	89	32	1
6.5	22	25	52	22	36	83	58	144	93	102	32	1.44
8.5	25	28	59	25	43	95	68	164	108	118	36	2.21
9.5	28	32	66	28	47	108	75	185	120	131	41	3.18
12	32	35	72	32	51	115	83	201	137	147	50	4.32
13.5	35	38	80	35	57	133	92	227	149	162	50	5.67
17	38	42	88	38	60	146	99	249	164	175	60	7.36
25	45	50	103	45	74	178	126	300	192	216	60	12.38

In inch

working load limit	diameter bow	diameter pin	diameter eye	width eye	width inside	length inside	width bow	length	length bolt	width	width bolt head	weight each
t	a inch	b inch	c inch	d inch	e inch	f inch	g inch	h inch	i inch	j inch	k inch	lbs
2	1/2	5/8	1 11/32	1/2	7/8	2	1 1/4	3 1/2	2 1/4	2 9/32	7/8	0.75
3.25	5/8	3/4	1 9/16	5/8	1 1/16	2 17/32	1 11/16	4 11/32	2 25/32	2 15/16	1 1/16	1.39
4.75	3/4	7/8	1 13/16	3/4	1 7/32	3	2	5 3/32	3 7/32	3 1/2	1 1/4	2.21
6.5	7/8	1	2 1/16	7/8	1 13/32	3 9/32	2 9/32	5 21/32	3 21/32	4 1/32	1 1/4	3.17
8.5	1	1 1/8	2 5/16	31/32	1 11/16	3 3/4	2 11/16	6 15/32	4 1/4	4 21/32	1 13/32	4.86
9.5	1 1/8	1 1/4	2 19/32	1 3/32	1 27/32	4 1/4	2 15/16	7 9/32	4 23/32	5 5/32	1 5/8	7.01
12	1 1/4	1 3/8	2 27/32	1 1/4	2	4 17/32	3 9/32	7 29/32	5 13/32	5 25/32	1 31/32	9.52
13.5	1 3/8	1 1/2	3 5/32	1 3/8	2 1/4	5 1/4	3 5/8	8 15/16	5 7/8	6 3/8	1 31/32	12.49
17	1 1/2	1 5/8	3 15/32	1 1/2	2 3/8	5 3/4	3 29/32	9 13/16	6 15/32	6 7/8	2 3/8	16.23
25	1 3/4	2	4 1/16	1 25/32	2 29/32	7	4 31/32	11 13/16	7 9/16	8 1/2	2 3/8	27.29



Green Pin® Fishing Dee Shackle SQ

Dee shackle with square headed screw pin



G-4154

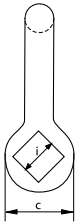
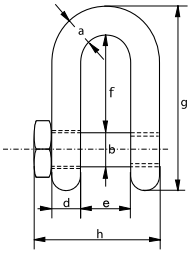

- **Material:** bow and pin high tensile steel, grade 6, quenched and tempered
- **Safety Factor:** MBL equals 6 x WLL
- **Standard:** EN 13889, ASME B30.26 and meets performance requirements of US Fed. Spec. RR-C-271, grade A
- **Finish:** hot dipped galvanized
- **Certification:** 2.1 2.2 3.1 MTC[®] CE

working load limit	diameter bow	diameter pin	diameter eye	width eye	width inside	length inside	length	length bolt	width bolt head	weight each
t	a mm	b mm	c mm	d mm	e mm	f mm	g mm	h mm	i mm	kg
2	13.5	16	34	13	22	43	81	57.5	22	0.32
3.25	16	19	40	16	27	51	97	71	27	0.58
4.75	19	22	46	19	31	59	112	82	32	0.92
6.5	22	25	52	22	36	73	134	93	32	1.33
8.5	25	28	59	25	43	85	154	108	36	2.03
9.5	28	32	66	28	47	90	167	120	41	2.88
12	32	35	72	32	51	94	180	137	50	3.96
13.5	35	38	80	35	57	115	209	149	50	5.24
17	38	42	88	38	60	127	230	164	60	6.8
25	45	50	103	45	74	149	271	192	60	11.22

In inch

working load limit	diameter bow	diameter pin	diameter eye	width eye	width inside	length inside	length	length bolt	width bolt head	weight each
t	a inch	b inch	c inch	d inch	e inch	f inch	g inch	h inch	i inch	lbs
2	1/2	5/8	1 11/32	1/2	7/8	1 11/16	3 3/16	2 1/4	7/8	0.7
3.25	5/8	3/4	1 9/16	5/8	1 1/16	2	3 13/16	2 25/32	1 1/16	1.28
4.75	3/4	7/8	1 13/16	3/4	1 7/32	2 5/16	4 13/32	3 7/32	1 1/4	2.03
6.5	7/8	1	2 1/16	7/8	1 13/32	2 7/8	5 9/32	3 21/32	1 1/4	2.93
8.5	1	1 1/8	2 5/16	31/32	1 11/16	3 11/32	6 1/16	4 1/4	1 13/32	4.48
9.5	1 1/8	1 1/4	2 19/32	1 3/32	1 27/32	3 17/32	6 9/16	4 23/32	1 5/8	6.35
12	1 1/4	1 3/8	2 27/32	1 1/4	2	3 11/16	7 3/32	5 13/32	1 31/32	8.72
13.5	1 3/8	1 1/2	3 5/32	1 3/8	2 1/4	4 17/32	8 7/32	5 7/8	1 31/32	11.56
17	1 1/2	1 5/8	3 15/32	1 1/2	2 3/8	5	9 1/16	6 15/32	2 3/8	15
25	1 3/4	2	4 1/16	1 25/32	2 29/32	5 7/8	10 21/32	7 9/16	2 3/8	24.74



Green Pin® Fishing Bow Shackle FP

Bow shackle with square sunken hole screw pin (flush pin)



G-4169

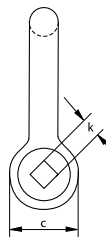
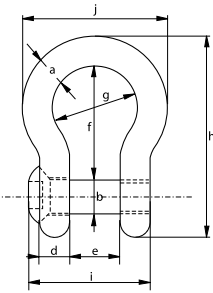

- **Material:** bow and pin high tensile steel, grade 6, quenched and tempered
- **Safety Factor:** MBL equals 6 x WLL
- **Standard:** EN 13889, ASME B30.26 and meets performance requirements of US Fed. Spec. RR-C-271, grade A
- **Finish:** hot dipped galvanized
- **Certification:** 2.1 2.2 3.1 MTC[®] CE
- **Note:** key for unscrewing the pin must be ordered separately

working load limit	diameter bow	diameter pin	diameter eye	width eye	width inside	length inside	width bow	length	length bolt	width	size hole head	weight each
t	a mm	b mm	c mm	d mm	e mm	f mm	g mm	h mm	i mm	j mm	k mm	kg
2	13.5	16	34	13	22	51	32	89	51	58	11	0.31
3.25	16	19	40	16	27	64	43	110	63	75	11	0.56
4.75	19	22	46	19	31	76	51	129	74	89	11	0.98
6.5	22	25	52	22	36	83	58	144	85	102	13	1.46
8.5	25	28	59	25	43	95	68	164	99	118	13	2.18
9.5	28	32	66	28	47	108	75	185	110	131	17	3.06
12	32	35	72	32	51	115	83	201	122	147	17	4.24
17	38	42	88	38	60	146	99	249	145	175	17	7.37

In inch

working load limit	diameter bow	diameter pin	diameter eye	width eye	width inside	length inside	width bow	length	length bolt	width	size hole head	weight each
t	a inch	b inch	c inch	d inch	e inch	f inch	g inch	h inch	i inch	j inch	k inch	lbs
2	1/2	5/8	1 11/32	1/2	7/8	2	1 1/4	3 1/2	2	2 9/32	7/16	0.68
3.25	5/8	3/4	1 9/16	5/8	1 1/16	2 17/32	1 11/16	4 11/32	2 15/32	2 15/16	7/16	1.23
4.75	3/4	7/8	1 13/16	3/4	1 7/32	3	2	5 3/32	2 29/32	3 1/2	7/16	2.16
6.5	7/8	1	2 1/16	7/8	1 13/32	3 9/32	2 9/32	5 21/32	3 11/32	4 1/32	1/2	3.22
8.5	1	1 1/8	2 5/16	31/32	1 11/16	3 3/4	2 11/16	6 15/32	3 29/32	4 21/32	1/2	4.81
9.5	1 1/8	1 1/4	2 19/32	1 3/32	1 27/32	4 1/4	2 15/16	7 9/32	4 11/32	5 5/32	21/32	6.75
12	1 1/4	1 3/8	2 27/32	1 1/4	2	4 17/32	3 9/32	7 29/32	4 13/16	5 25/32	21/32	9.35
17	1 1/2	1 5/8	3 15/32	1 1/2	2 3/8	5 3/4	3 29/32	9 13/16	5 23/32	6 7/8	21/32	16.25

E-4170

Green Pin® Sunken Hole Key

Accessory for fishing shackle with square sunken hole

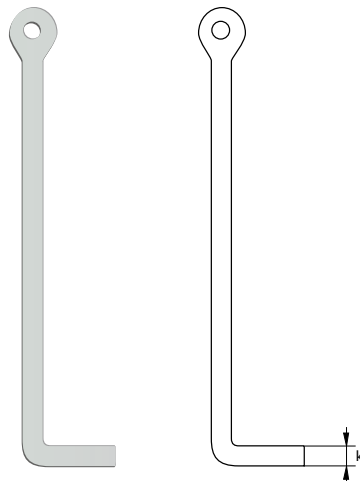



Green Pin® Fishing Dee Shackle FP

Dee shackle with square sunken hole screw pin (flush pin)

- **Material:** bow and pin high tensile steel, grade 6, quenched and tempered
- **Safety Factor:** MBL equals 6 x WLL
- **Standard:** EN 13889, ASME B30.26 and meets performance requirements of US Fed. Spec. RR-C-271, grade A
- **Finish:** hot dipped galvanized
- **Certification:** 2.1 2.2 3.1 MTC[®] CE
- **Note:** key for unscrewing the pin must be ordered separately



G-4159

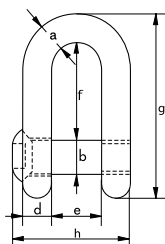

working load limit	diameter bow	diameter pin	diameter eye	width eye	width inside	length inside	length	length bolt	size hole head	weight each
t	a mm	b mm	c mm	d mm	e mm	f mm	g mm	h mm	i mm	kg
2	13.5	16	34	13	22	43	81	51	11	0.34
3.25	16	19	40	16	27	51	97	63	11	0.6
4.75	19	22	46	19	31	59	112	74	11	0.98
6.5	22	25	52	22	36	73	134	85	13	1.26
8.5	25	28	59	25	43	85	154	99	13	2.14
9.5	28	32	66	28	47	90	167	110	17	3.05
12	32	35	72	32	51	94	180	122	17	3.56
17	38	42	88	38	60	127	230	145	17	6.84

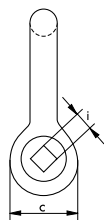

In inch

working load limit	diameter bow	diameter pin	diameter eye	width eye	width inside	length inside	length	length bolt	size hole head	weight each
t	a inch	b inch	c inch	d inch	e inch	f inch	g inch	h inch	i inch	lbs
2	1/2	5/8	1 11/32	1/2	7/8	1 11/16	3 3/16	2	7/16	0.75
3.25	5/8	3/4	1 9/16	5/8	1 1/16	2	3 13/16	2 15/32	7/16	1.33
4.75	3/4	7/8	1 13/16	3/4	1 7/32	2 5/16	4 13/32	2 29/32	7/16	2.15
6.5	7/8	1	2 1/16	7/8	1 13/32	2 7/8	5 9/32	3 11/32	1/2	2.77
8.5	1	1 1/8	2 5/16	31/32	1 11/16	3 11/32	6 1/16	3 29/32	1/2	4.72
9.5	1 1/8	1 1/4	2 19/32	1 3/32	1 27/32	3 17/32	6 9/16	4 11/32	21/32	6.72
12	1 1/4	1 3/8	2 27/32	1 1/4	2	3 11/16	7 3/32	4 13/16	21/32	7.84
17	1 1/2	1 5/8	3 15/32	1 1/2	2 3/8	5	9 1/16	5 23/32	21/32	15.08

E-4170

Green Pin® Sunken Hole Key

Accessory for fishing shackle with square sunken hole

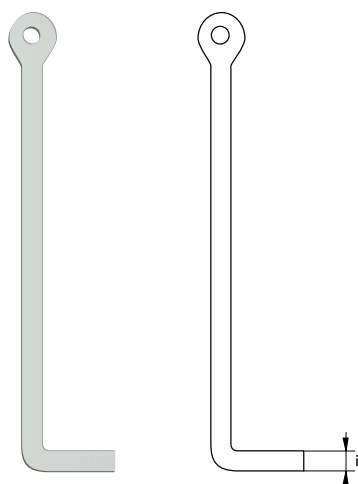

C

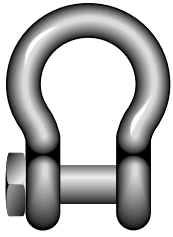

P-3764

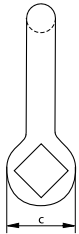
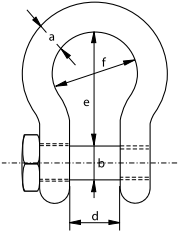

Fishing Shackles

Bow shackle with square head screw pin

- **Material:** mild steel
- **Safety factor:** MBL equals 5 x WLL
- **Finish:** painted blue
- **Certification:** 2.1 2.2

working load limit	diameter bow	diameter pin	diameter eye	width inside	length inside	width bow	weight each
t	a mm	b mm	c mm	d mm	e mm	f mm	kg
1.5	13	16	32	25	48	36	0.37
2.5	16	20	40	32	64	48	0.71
3	20	22	48	38	79	60	1.24

C



P-3754

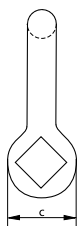
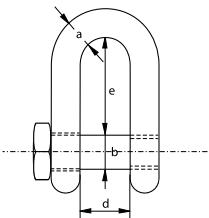

Fishing Shackles

Dee shackle with square head screw pin

- **Material:** mild steel
- **Safety factor:** MBL equals 5 x WLL
- **Finish:** painted blue
- **Certification:** 2.1 2.2

working load limit	diameter bow	diameter pin	diameter eye	width inside	length inside	weight each
t	a mm	b mm	c mm	d mm	e mm	kg
1.5	13	16	32	25	48	0.36
2.5	16	20	40	32	64	0.69
3	20	22	48	38	75	1.18
4	22	25	53	44	83	1.61

C

Mooring Shackles

Bow shackle with screw pin

- **Material:** mild steel, untreated, grade 3
- **Finish:** self coloured
- **Note:** not to be used for lifting applications
- **Certification:** 2.1

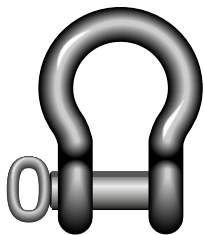

S-1165

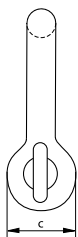
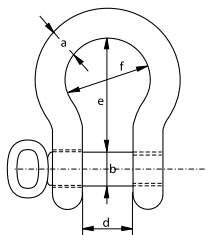

diameter bow	diameter pin	diameter eye	width inside	length inside	width bow	weight each
a mm	b mm	c mm	d mm	e mm	f mm	kg
32	32	74	64	134	96	4.2
38	38	89	76	160	114	7.8
45	45	104	90	189	135	12.5
50	50	111	100	210	155	17.4
65	65	145	130	273	195	35.6

C

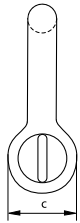
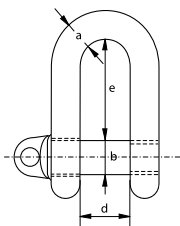
S-3351
G-3351

Shackles generally to DIN 82101 type A

Dee shackle with screw collar pin

- **Material:** bow and pin high tensile steel, grade 4
- **Safety Factor:** MBL equals 5 x WLL
- **Standard:** generally to DIN 82101 type A
- **Finish:** hot dipped galvanized or self coloured
- **Certification:** 2.1 2.2 CE
- **Note:** shackle no. 0.1 is electro-galvanized and will not have any markings as it is too small

no.	working load limit	diameter bow	diameter pin	diameter eye	width inside	length inside	weight each
	t	a mm	b mm	c mm	d mm	e mm	kg
0.1	0.1	5	5	10	7	15.5	0.02
0.16	0.16	6	6	12	8	18	0.02
0.25	0.25	8	8	16	11	24	0.05
0.4	0.4	10	10	20	14	30	0.1
0.6	0.63	12	12	24	17	36	0.18
1	1	13	16	32	21	49	0.3
1.6	1.6	16	20	40	27	61	0.57
2	2	20	22	44	30	67	0.98
2.5	2.5	22	24	48	33	73	1.3
3	3.15	25	27	54	38	83.5	1.85
4	4	28	30	60	42	91	2.53
5	5	32	36	72	47	111	4
6	6.3	36	39	78	53	119.5	5.3
8	8	41	45	90	60	139.5	7.9
10	10	44	48	96	66	147	10
12	12	49	52	104	73	158	13.5
16	16	55	60	120	81	185	19.2
20	20	61	68	136	90	211	28
25	25	67	72	144	100	221	34

C

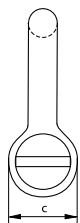
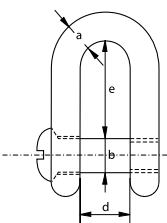
S-3352
G-3352

Shackles generally to DIN 82101 type B

Dee shackle with counter sunk screw pin

- **Material:** bow and pin high tensile steel, grade 4
- **Safety Factor:** MBL equals 5 x WLL
- **Standard:** generally to DIN 82101 type B
- **Finish:** hot dipped galvanized or self coloured
- **Certification:** 2.1 2.2 CE
- **Note:** shackle no. 0.1 is electro-galvanized and will not have any markings as it is too small

no.	working load limit	diameter bow	diameter pin	diameter eye	width inside	length inside	weight each
	t	a mm	b mm	c mm	d mm	e mm	kg
0.1	0.1	5	5	10	7	15.5	0.01
0.16	0.16	6	6	12	8	18	0.02
0.25	0.25	8	8	16	11	24	0.05
0.4	0.4	10	10	20	14	30	0.09
0.6	0.63	12	12	24	17	36	0.17
1	1	13	16	32	21	49	0.29
1.6	1.6	16	20	40	27	61	0.54
2	2	20	22	44	30	67	0.98
2.5	2.5	22	24	48	33	73	1.23
3	3.15	25	27	54	38	83.5	1.8
4	4	28	30	60	42	91	2.6
5	5	32	36	72	47	111	3.8
6	6.3	36	39	78	53	119.5	5.2
8	8	41	45	90	60	139.5	7.6
10	10	44	48	96	66	147	9.7

C

Shackles generally to DIN 82101 type C

Dee shackle with safety bolt

- **Material:** bow and pin high tensile steel, grade 4
- **Safety Factor:** MBL equals 5 x WLL
- **Standard:** generally to DIN 82101 type C
- **Finish:** hot dipped galvanized or self coloured
- **Certification:** 2.1 2.2 CE
- **Note** : with screw collar pin : up to size no. 25
: with hand-grip : from size no. 32

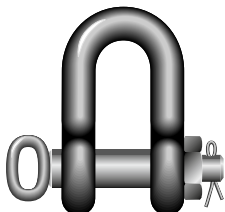
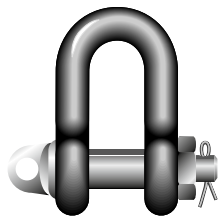

S-3356
G-3356

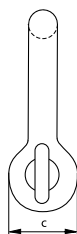
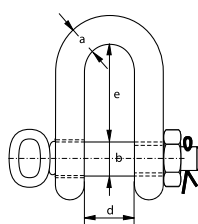
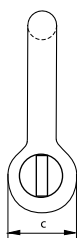
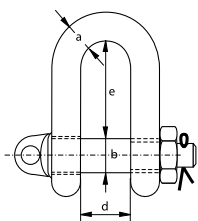

no.	working load limit	diameter bow	diameter pin	diameter eye	width inside	length inside	weight each
	t	a mm	b mm	c mm	d mm	e mm	kg
0.4	0.4	10	10	20	14	30	0.11
0.6	0.63	12	12	24	17	36	0.2
1	1	13	16	32	21	49	0.37
1.6	1.6	16	20	40	27	61	0.69
2	2	20	22	44	30	67	1.13
2.5	2.5	22	24	48	33	73	1.5
3	3.15	25	27	54	38	83.5	2.15
4	4	28	30	60	42	91	2.93
5	5	32	36	72	47	111	4.7
6	6.3	36	39	78	53	119.5	6.33
8	8	41	45	90	60	139.5	8.6
10	10	44	48	96	66	147	10.8
12	12	49	52	104	73	158	14.4
16	16	55	60	120	81	185	20.5
20	20	61	68	136	90	211	27.9
25	25	67	72	144	100	221	36
32	32	74	80	160	110	246	49
40	40	75	90	180	125	276	70
50	50	88	100	200	140	307	100
63	63	96	110	220	155	339	140
80	80	110	125	250	175	385.5	200
100	100	125	140	280	200	430	280

C



G-3161

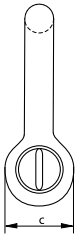
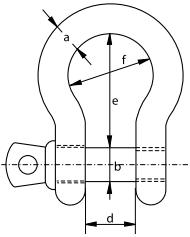

Yellow Pin Shackles

Bow shackle with screw collar pin

- **Material:** bow and pin high tensile steel, grade 6
- **Standard:** generally to US Fed. Spec. RR-C-271
- **Finish:** hot dipped galvanized
- **Certification:** 2.1 2.2 CE
- **Note:** import quality

working load limit	diameter bow	diameter pin	diameter eye	width inside	length inside	width bow	weight each
t	a mm	b mm	c mm	d mm	e mm	f mm	kg
0.33	5	6	14	9.5	22	15	0.03
0.5	6	8	16	12	29	20	0.05
0.75	8	10	19	13.5	31	21	0.08
1	10	11	23	17	37	26	0.14
1.5	11	13	27	19	43	29	0.2
2	13	16	30	20	48	33	0.33
3.25	16	19	38	27	60	43	0.62
4.75	19	22	46	32	71	50	1.07
6.5	22	25	53	36	84	58	1.62
8.5	25	28	61	43	95	68	2.28
9.5	28	32	68	46	108	74	3.36
12	32	35	76	51	119	82	4.31
13.5	35	38	84	57	133	92	6.14
17	38	42	92	60	146	98	7.81
25	45	50	106	73	177	127	12.61

C

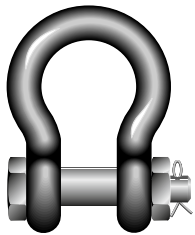

G-3163

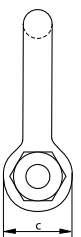
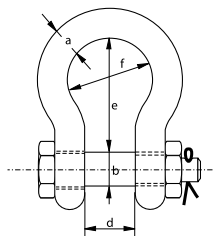

Yellow Pin Shackles

Bow shackle with safety bolt

- **Material:** bow and pin high tensile steel, grade 6
- **Standard:** generally to US Fed. Spec. RR-C-271
- **Finish:** hot dipped galvanized
- **Certification:** 2.1 2.2 CE
- **Note:** import quality

working load limit	diameter bow	diameter pin	diameter eye	width inside	length inside	width bow	weight each
t	a mm	b mm	c mm	d mm	e mm	f mm	kg
2	13	16	30	20	48	33	0.36
3.25	16	19	38	27	60	43	0.7
4.75	19	22	46	32	71	50	1.1
6.5	22	25	53	36	84	58	1.61
8.5	25	28	61	43	95	68	2.42
9.5	28	32	68	46	108	74	3.35
12	32	35	76	51	119	82	5.32
13.5	35	38	84	57	133	92	7.19
17	38	42	92	60	146	98	9.44
25	45	50	106	73	177	127	13.8

C

Yellow Pin Shackles

Dee shackle with screw collar pin

- **Material:** bow and pin high tensile steel, grade 6
- **Standard:** generally to US Fed. Spec. RR-C-271
- **Finish:** hot dipped galvanized
- **Certification:** 2.1 2.2 CE
- **Note:** import quality



G-3151

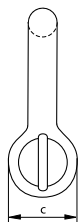
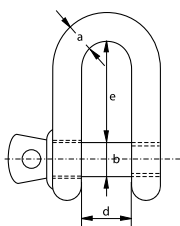

working load limit	diameter bow	diameter pin	diameter eye	width inside	length inside	weight each
t	a mm	b mm	c mm	d mm	e mm	kg
0.33	5	6	12	9.5	19	0.03
0.5	6	8	16	12	22	0.04
0.75	8	10	19	13.5	26	0.08
1	10	11	23	17	32	0.13
1.5	11	13	27	19	37	0.2
2	13	16	30	20	41	0.28
3.25	16	19	38	27	51	0.57
4.75	19	22	46	32	60	1.19
6.5	22	25	53	36	71	1.43
8.5	25	28	61	43	81	2.16
9.5	28	32	68	46	90	3.06
12	32	35	76	51	100	4.11
13.5	35	38	84	57	111	5.28
17	38	42	92	60	122	6.69
25	45	50	106	73	146	12.14

C

Yellow Pin Shackles

Dee shackle with safety bolt

- **Material:** bow and pin high tensile steel, grade 6
- **Standard:** generally to US Fed. Spec. RR-C-271
- **Finish:** hot dipped galvanized
- **Certification:** 2.1 2.2 CE
- **Note:** import quality

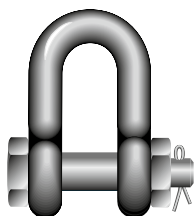

G-3153

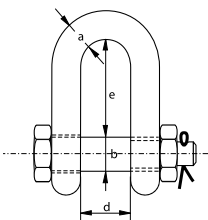

working load limit	diameter bow	diameter pin	diameter eye	width inside	length inside	weight each
t	a mm	b mm	c mm	d mm	e mm	kg
2	13	16	30	20	41	0.33
3.25	16	19	38	27	51	0.62
4.75	19	22	46	32	60	1.02
6.5	22	25	53	36	71	1.49
8.5	25	28	61	43	81	2.26
9.5	28	32	68	46	90	3.2
12	32	35	76	51	100	4.91
13.5	35	38	84	57	111	5.84
17	38	42	92	60	122	8.4
25	45	50	106	73	146	11.9

C



S-2751
G-2751

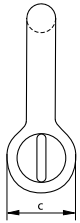
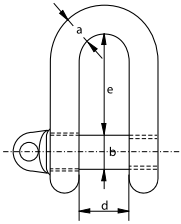

Shackles generally to B.S. 3032 table 2

Large dee shackle with screw collar pin

- **Material:** bow and pin alloy steel, EN 14a
- **Safety Factor:** MBL equals 4 x WLL
- **Standard:** generally to B.S. 3032 table 2
- **Finish:** hot dipped galvanized or self coloured
- **Certification:** 2.1 2.2 CE

working load limit	diameter bow	diameter pin	diameter eye	width inside	length inside	weight each
t	a mm	b mm	c mm	d mm	e mm	kg
0.25	6	10	19	13	25	0.11
0.5	10	13	25	19	38	0.17
0.75	13	16	32	28	54	0.35
1.5	16	19	38	32	64	0.66
2	19	22	44	38	73	1.02
3	22	25	51	44	83	1.57
3.75	25	28	57	51	95	2.3
5	28	32	64	54	105	3.2
6	32	35	70	60	114	4.3
7	35	38	76	67	127	5.4
9.5	38	45	83	70	137	6.8
11.25	42	48	89	76	146	8.7
13	44	51	95	83	156	11
14.25	48	54	108	92	178	14.3
16.25	51	57	114	98	187	20
18	54	60	121	105	197	26.4
20	57	64	127	108	210	28.3
25	64	73	146	121	235	35
30	70	79	159	133	260	49
35	76	86	171	146	279	63.6
40	79	89	178	149	292	71.7
50	89	102	203	171	330	101
65	102	114	229	191	375	151
80	114	127	254	219	419	215

C

Commercial Shackles

Bow shackle with screw collar pin

- **Material:** mild steel, untreated, grade 3
- **Finish:** electro-galvanized
- **Certification:** 2.1
- **Note:** not to be used for lifting applications



E-1161

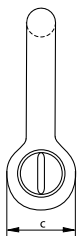
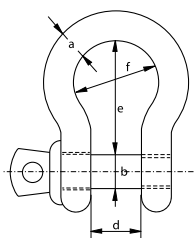

diameter bow	diameter pin	diameter eye	width inside	length inside	width bow	weight per 100 pcs
a mm	b mm	c mm	d mm	e mm	f mm	kg
5	5	10	10	20	15	1.4
6	6	12	12	24	18	2.4
8	8	16	16	32	24	5.4
10	10	20	20	40	30	10.6
11	11	22	22	44	33	16.4
12	12	24	24	48	36	19.4
14	14	28	28	56	42	44
16	16	32	32	64	48	44.2
19	19	38	38	76	57	82.8
22	22	44	44	88	66	116
25	25	50	50	100	75	168
28	28	56	56	112	84	232
32	32	64	64	128	96	382
38	38	76	76	152	114	623

C

Commercial Shackles

Bow shackle with square head screw pin

- **Material:** mild steel, untreated, grade 3
- **Finish:** self coloured
- **Certification:** 2.1
- **Note:** not to be used for lifting applications

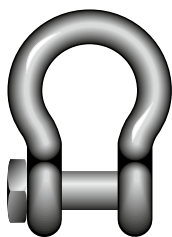

S-1164

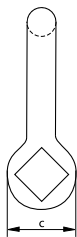
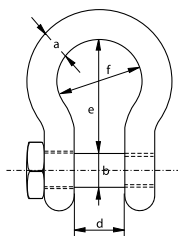

diameter bow	diameter pin	diameter eye	width inside	length inside	width bow	weight per 100 pcs
a mm	b mm	c mm	d mm	e mm	f mm	kg
6	6	12	12	24	18	2.7
8	8	16	16	32	24	6.4
10	10	20	20	40	30	12.5
11	11	22	22	44	33	16.6
12	12	24	24	48	36	21.6
14	14	28	28	56	42	34.3
16	16	32	32	64	48	51.2
19	19	38	38	76	57	100
22	22	44	44	88	66	133
25	25	50	50	100	75	195
28	28	56	56	112	84	275
32	32	64	64	128	96	410
38	38	76	76	152	114	686

C

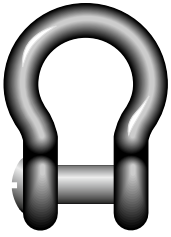

E-1162

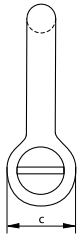
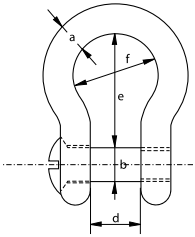

Commercial Shackles

Bow shackle with counter sunk screw pin

- **Material:** mild steel, untreated, grade 3
- **Finish:** electro-galvanized
- **Certification:** 2.1
- **Note:** not to be used for lifting applications

diameter bow	diameter pin	diameter eye	width inside	length inside	width bow	weight per 100 pcs
a mm	b mm	c mm	d mm	e mm	f mm	kg
8	8	16	16	32	24	6
10	10	20	20	40	30	11.6
11	11	22	22	44	33	15.5
12	12	24	24	48	36	20.1
14	14	28	28	56	42	31.9
16	16	32	32	64	48	47.6
19	19	38	38	76	57	93.1
22	22	44	44	88	66	124
25	25	50	50	100	75	182

C



E-1151

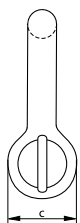
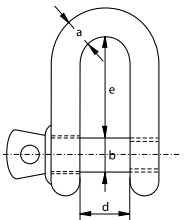

Commercial Shackles

Dee shackle with screw collar pin

- **Material:** mild steel, untreated, grade 3
- **Finish:** electro-galvanized
- **Certification:** 2.1
- **Note:** not to be used for lifting applications

diameter bow	diameter pin	diameter eye	width inside	length inside	weight per 100 pcs
a mm	b mm	c mm	d mm	e mm	kg
5	5	10	10	20	1.4
6	6	12	12	24	2.2
8	8	16	16	32	5.2
10	10	20	20	40	11.8
11	11	22	22	44	14
12	12	24	24	48	20.5
14	14	28	28	56	29.4
16	16	32	32	64	42.6
19	19	38	38	76	72.6
22	22	44	44	88	108
25	25	50	50	100	185
28	28	56	56	112	226
32	32	64	64	128	358
38	38	76	76	152	602

C

Commercial Shackles

Dee shackle with square head screw pin



S-1154

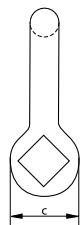
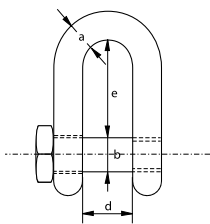

- **Material:** mild steel, untreated, grade 3
- **Finish:** self coloured
- **Certification:** 2.1
- **Note:** not to be used for lifting applications

diameter bow	diameter pin	diameter eye	width inside	length inside	weight per 100 pcs
a mm	b mm	c mm	d mm	e mm	kg
6	6	12	12	24	2.6
8	8	16	16	32	6.17
10	10	20	20	40	12
11	11	22	22	44	16
12	12	24	24	48	20.8
14	14	28	28	56	33.1
16	16	32	32	64	49.4
19	19	38	38	76	96.4
22	22	44	44	88	128
25	25	50	50	100	188
28	28	56	56	112	265
32	32	64	64	128	395
38	38	76	76	152	661

THIMBLES



Applications

Thimbles are used to protect steel wire rope, fibre rope or synthetic rope. They are available in various models and sizes. All indicated types of thimbles in this catalogue can be used in combination with the above mentioned types of ropes.

Range

To complement the Green Pin® assortment, Van Beest offers a wide range of thimbles, from standardized models to various types of commercial thimbles.

Design

Thimbles can be cold-rolled, hot-rolled or die-cast, depending on the specific type of thimble.

Finish

The finish can be self coloured, painted, electro-galvanized or hot dipped galvanized.

Certification

Specific details of certificate availability can be found on each product page. Please verify your certification requirements at the time of order.

Instructions for use

Thimbles must be regularly inspected in accordance with the standards given in the country of use. This is required because the products in use may be affected by wear, misuse, overloading which may lead to deformation and/or alteration of the steel structure.

Make sure that the (wire) rope fits properly into the groove of the thimble you use. The nominal size of the thimble represents the diameter of the (wire) rope for which it is intended to be used. If there is no thimble available with a nominal size that meets the size of your (wire) rope, the next larger size of thimble must be used.

Before use, check if the thimble is free from impurities, sharp edges, cracks or other irregularities which may damage the wire rope and therefore affect the performance of the wire rope.

C

Thimbles

Standard commercial

- **Material:** mild steel
- **Finish:** electro-galvanized
- **Certification:** 2.1



E-6110

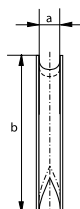
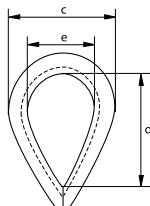

diameter rope	width groove	length	width	length inside	width inside	weight per 100 pcs
mm	a mm	b mm	c mm	d mm	e mm	kg
3	3	24	18	15	10	0.4
4	4	25	19	16	11	0.5
5	5	31	22	22	16	0.8
6	6	37	29	26	19	1.4
8	8	51	38	34	24	2.8
9	9	57	42	38	29	3
10	10	64	44	42	32	4.8
11	11	70	51	48	35	7.5
12	12	76	57	51	38	8
14	14	82	60	57	40	10
16	16	89	64	60	42	15
18	18	102	69	67	45	22
20	20	115	79	76	51	25
22	22	127	89	83	54	32
24	24	140	102	88	64	46
26	26	152	105	102	68	66
28	28	165	115	110	73	77
30	30	178	121	115	79	80
32	32	203	133	140	93	130

C

Thimbles

Heavy duty stub-end

- **Material:** mild steel
- **Finish:** hot dipped galvanized
- **Certification:** 2.1



G-6120

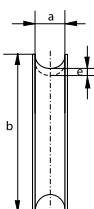
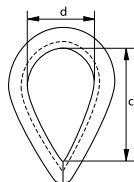

diameter rope	width groove	length	length inside	width inside	thickness back	weight per 100 pcs
mm	a mm	b mm	c mm	d mm	e mm	kg
8	9	51	37	23	4	6
10	11	64	53	31	4	7
12	13	76	60	36	5	14
14	15	89	68	46	6	22
16	17	102	79	51	6	24
18	19	114	90	55	8	43
20	21	127	98	62	9	65
22	23	140	112	67	10	93
24	25	152	119	72	10	102
28	29	178	135	82	10.5	135
32	33	203	163	102	10.5	162
36	37	229	185	117	12	363
40	42	254	205	122	12	376
44	46	280	220	133	15	608
50	52	305	221	143	20	960
56	58	356	252	163	20	1400
64	67	407	286	185	20	1700



G-6128

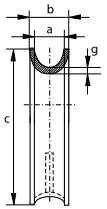
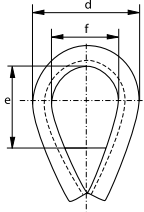

Thimbles

Heavy duty stub-end reinforced with welded fillet plate

- **Material:** mild steel
- **Finish:** hot dipped galvanized reinforced with a welded fillet plate
- **Certification:** 2.1

width groove	width overall	length	width	length inside	width inside	thickness back	weight per piece
a mm	b mm	c mm	d mm	e mm	f mm	g mm	kg
35	55	220	150	100	80	10	3.2
40	65	245	160	120	90	12	5.1
50	80	290	200	125	110	16	9.2
62	100	360	250	160	140	20	17.4
72	115	390	265	175	160	20	19.4
85	125	470	300	245	190	20	29
100	150	540	370	290	200	25	39
115	165	570	380	300	210	25	52

For shackle

group	width groove								
	a mm								
	35	40	50	62	72	85	100	115	
G-4161	17, 25	25	35, 42.5	55	85				
G-4163	17, 25	25	35, 42.5	55	85				
G-4151	17, 25	25	35, 42.5	55	85				
G-4153	17, 25	25	35, 42.5	55	85				
P-6036						120, 150	150, 200		
G-6038						120, 150	150, 200		
P-6033	30	30	40, 55	75	125	125			
G-5263	30, 40	40		85	120	150, 175	175		
G-5163	17, 25	25	35, 42.5	55	85				
P-6031						120, 150	150, 200		
G-4263	4.75 ~ 25	6.5 ~ 25	9.5 ~ 30	16 ~ 55	25 ~ 75	30 ~ 75	55, 75	75	
P-5363	17, 25	25	35, 42.5	55	85				
P-5365	17, 25	25	35, 42.5	55	85	120, 150	150, 200		
P-5367	17, 25	25	35, 42.5	55	85	120, 150	150		
G-4164	17, 25	25							
G-4154	17, 25	25							
G-4169	17								
G-4159	17								

C

Thimbles

Generally to DIN 6899 (B)

- **Material:** mild steel
- **Standard:** generally to DIN 6899 (B)
- **Finish:** thimbles for rope diameters up to and including 6 mm are electro-galvanized, other diameters are hot dipped galvanized
- **Certification:** 2.1



E-6131
G-6131

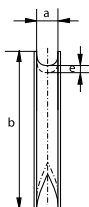
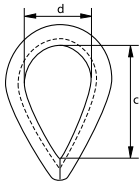

diameter rope	width groove	length	length inside	width inside	thickness back	weight per 100 pcs
mm	a mm	b mm	c mm	d mm	e mm	kg
2.5	3	22	19	12	1.6	0.6
3.5	4	26	21	13	1.6	0.8
4	5	32	23	14	1.9	1
5	6	38	25	16	2.4	2
6	7	44	28	18	2.4	2
7	8	51	32	20	2.8	2.7
9	10	57	38	24	3.1	4.1
11	12	64	45	28	3.3	6.9
13	13	70	48	30	3.3	7.2
13	14	76	51	32	3.7	10.2
15	16	83	58	36	3.8	16.4
16	17	89	61	38	4.7	19
17	18	95	64	40	4.7	20.3
18	20	102	72	45	5.7	27.3
20	22	114	80	50	5.7	30.8
22	24	127	90	56	6.5	44.8
24	26	140	99	62	6.8	59.2
26	28	152	112	70	8	72
28	30	165	120	75	8	104
30	32	178	128	80	8	115
32	34	203	152	95	8.5	153
34	36	216	160	100	8.5	176
36	38	229	176	110	8.5	176
38	40	241	184	115	10.5	292
40	42	254	192	120	10.5	320
42	45	305	240	150	10.5	364
47	50	360	265	160	12	535
57	60	380	275	170	12	790
63	65	420	300	180	13	830
72	75	460	350	200	15	1200
87	90	500	370	210	18	2600
97	100	550	380	220	20	3050



S-6134

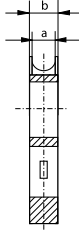
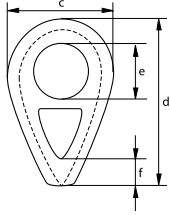

Thimbles

According to DIN 3091

- **Material:** cast mild steel, (GTW 40)
- **Standard:** according to DIN 3091
- **Finish:** self coloured
- **Certification:** 2.1
- **Note:** the diameter (e) of the thimble for diameter wire rope 72 mm is 140 mm

diameter rope	width groove	width overall	width	length	diameter	length	weight per 100 pcs
mm	a mm	b mm	c mm	d mm	e mm	f mm	kg
8	9	15	40	66	14	-	18
10	11	17.5	50	82	18	-	32
12	13	20	60	98	21	-	52
14	16	23.5	70	114	25	-	80
16	18	26	80	130	28	16	90
18	20	28.5	90	145	31	18	121
20	22	31	100	161	35	20	161
22	24	33.5	110	177	38	22	211
24	26	36	120	193	41	24	271
26	29	39.5	130	209	44	26	355
28	31	42	140	224	47	28	420
32	35	47	160	256	53	32	630
36	40	53	180	288	59	36	884
40	44	58	200	320	65	40	1100
44	48	63	220	352	70	44	1500
48	53	69	240	384	76	48	2000
52	57	74	260	416	81	52	2500
56	62	80	280	448	86	56	3200
64	70	90	320	512	95	64	4600
72	79	101	360	576	140	72	6600

C

Thimbles

Generally to DIN 3090

- **Material:** mild steel
- **Standard:** generally to DIN 3090
- **Finish:** for diameter 4 and 6 mm electro-galvanized
other diameters hot dipped galvanized
- **Certification:** 2.1



E-6135
G-6135

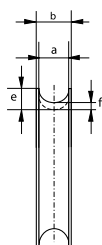
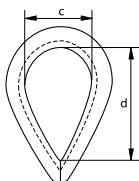

diameter wire rope	width groove	width overall	width inside	length inside	thickness	thickness back	weight per 100 pcs
mm	a mm	b mm	c mm	d mm	e mm	f mm	kg
4	5	9	10	20	5.1	2.1	1.4
6	7	12	15	30	7.1	2.6	3
8	9	13	20	40	11	4	7.1
10	11	16	25	50	14	5	17
12	13	19	30	60	16	6	24
14	16	22	35	70	17	7	31
16	18	25	40	80	19	8	50
18	20	27	45	90	21	9	62
20	22	32	50	100	23	10	90
22	24	33	55	110	24	10	100
24	26	37	60	120	27	11	130
26	29	46	65	130	30	12	220
28	31	50	70	140	33	12	240
32	35	55	80	160	38	14	216
36	40	60	90	180	42	16	430
40	44	65	100	200	46	18	570
44	48	70	110	220	53	20	850
48	53	75	120	240	58	22	1120
52	57	80	130	260	64	25	1530
56	62	85	140	280	67	25	2148
60	66	90	150	300	70	25	2300
64	70	95	160	320	78	30	3500
68	75	100	170	340	81	30	3700
72	79	105	180	360	84	30	4100
76	84	115	190	380	87	30	4600
80	88	120	200	400	90	30	5400



Thimbles

Generally to EN 13411-1

- **Material:** mild steel
- **Standard:** generally to EN 13411-1 formerly BS 464
- **Finish:** hot dipped galvanized
- **Certification:** 2.1



G-6170

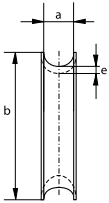
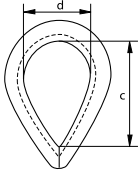

diameter rope		width groove	length	length inside	width inside	thickness back	weight per 100 pcs
inch	mm	a mm	b mm	c mm	d mm	e mm	kg
³ / ₁₆	5	5.5	44	28	19	3	3.5
¹ / ₄	7	6	48	30	20	3.5	2.8
⁵ / ₁₆	8	8	54	33	22	4	5.7
³ / ₈	10	10	64	38	25	4.8	8
⁷ / ₁₆	11	13	73	41	29	4.8	14.2
¹ / ₂	13	14	80	44	32	5.6	18
⁹ / ₁₆	15	15	80	44	32	5.6	18.9
⁵ / ₈	16	17	98	59	41	7.9	22.4
¹¹ / ₁₆	17	19	108	67	44	7.9	39.7
³ / ₄	19	20	124	73	51	9.5	45.6
¹³ / ₁₆	21	21	124	73	51	9.5	62.4
⁷ / ₈	22	23	133	83	57	9.5	61.5
¹⁵ / ₁₆	24	25	146	92	64	10.3	106
1	25	27	162	108	70	10.3	97.3
1 ¹ / ₈	28	29	178	111	76	12.7	151
1 ¹ / ₄	32	33	197	133	95	12.7	204
1 ³ / ₈	35	38	229	152	105	15.9	318
1 ¹ / ₂	38	41	254	165	114	17.5	363
1 ⁵ / ₈	42	46	254	165	114	17.5	499
1 ³ / ₄	45	51	286	178	127	25.4	556
1 ⁷ / ₈	47	60	318	191	133	28.6	-
2	50	64	330	203	140	28.6	-
2 ¹ / ₈	54	64	330	203	140	28.6	-
2 ¹ / ₄	57	67	356	216	146	30.2	-
2 ¹ / ₂	65	70	413	241	159	31.8	-
2 ³ / ₄	70	86	502	273	203	41.3	-

C

Thimbles

Generally to US Fed. Spec. FF-T-276b type III

- **Material:** mild steel
- **Standard:** generally to US Federal Specification FF-T-276b type III and generally to EN 13411-1
- **Finish:** hot dipped galvanized
- **Certification:** 2.1



G-6142

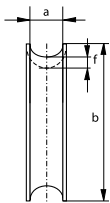
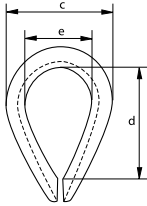

diameter rope	width groove	length	width	length inside	width inside	thickness back	weight per 100 pcs
mm	a mm	b mm	c mm	d mm	e mm	f mm	kg
6	7	55.5	38	41	22	1.6	2.7
8	9	63.5	46	47.5	27	2	5.1
9	10	73	54	54	28.5	2.8	9.1
11	12	82.5	60	60	32	3.2	13.9
13	13.5	92	70	70	38	3.6	19.9
14	15	92	68	70	38	3.6	20.5
16	16.5	108	79	82.5	44.5	4	29.8
19	20	127	97	95	51	5.5	60.8
22	24	140	108	108	57	5.5	80.4
25	27	156	125	114	63.5	6.3	109
28 - 32	30	178	149	130	73	6.3	147
32 - 35	33	205	173	159	89	12.7	366
35 - 38	36.5	229	181	165	89	12.7	478
41	43.5	286	206	203	102	12.7	731
45	47	310	216	229	114	12.7	778
48 - 51	50	384	264	305	152	12.7	1150
57	59.5	435	302	356	178	12.7	1935
64	66	464	311	378	178	19	2640
76	78.5	514	356	419	200	19	3850

In inch

diameter rope	width groove	length	width	length inside	width inside	thickness back	weight per 100 pcs
inch	a inch	b inch	c inch	d inch	e inch	f inch	lbs
1/4	9/32	2 3/16	1 1/2	1 5/8	7/8	1/16	5.9
5/16	11/32	2 1/2	1 13/16	1 7/8	1 1/16	5/64	11.2
3/8	13/32	2 7/8	2 1/8	2 1/8	1 1/8	7/64	20.1
7/16	15/32	3 1/4	2 3/8	2 3/8	1 1/4	1/8	30.6
1/2	17/32	3 5/8	2 3/4	2 3/4	1 1/2	9/64	43.9
9/16	19/32	3 5/8	2 11/16	2 3/4	1 1/2	9/64	45.2
5/8	21/32	4 1/4	3 1/8	3 1/4	1 3/4	5/32	65.7
3/4	25/32	5	3 13/16	3 3/4	2	7/32	134
7/8	15/16	5 1/2	4 1/4	4 1/4	2 1/4	7/32	177
1	1 1/16	6 1/8	4 15/16	4 1/2	2 1/2	1/4	241
1 1/8 - 1 1/4	1 3/16	7	5 7/8	5 1/8	2 7/8	1/4	324
1 1/4 - 1 3/8	1 5/16	8 1/16	6 13/16	6 1/4	3 1/2	1/2	807
1 3/8 - 1 1/2	1 7/16	9	7 1/8	6 1/2	3 1/2	1/2	1054
1 5/8	1 23/32	11 1/4	8 1/8	8	4	1/2	1612
1 3/4	1 27/32	12 3/16	8 1/2	9	4 1/2	1/2	1715
1 7/8 - 2	1 31/32	15 1/8	10 3/8	12	6	1/2	2535
2 1/4	2 11/32	17 1/8	11 7/8	14	7	1/2	4266
2 1/2	2 19/32	18 1/4	12 1/4	14 7/8	7	3/4	5820
3	3 3/32	20 1/4	14	16 1/2	7 7/8	3/4	8488



Thimbles

Pennant line type



G-6151

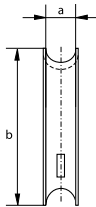
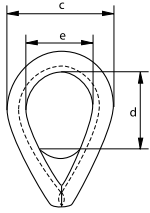

- **Material:** mild steel
- **Finish:** hot dipped galvanized produced with a welded fillet plate
- **Certification:** 2.1

diameter wire rope	width groove	length	width	length inside	width inside	weight each
mm	a mm	b mm	c mm	d mm	e mm	kg
16	17	102	75	50	50	0.4
18	19	114	85	50	53	0.5
20	21	127	100	60	60	0.8
22	23	140	110	60	65	0.9
24	25	152	115	70	70	1
28	30	178	135	75	80	1.7
30	33	203	155	80	100	2.5
36	38	229	175	110	115	4
40	41	254	190	120	120	4.5
44	46	279	210	120	130	7
50	52	305	225	140	140	8.3
56	60	356	240	150	150	12.5
64	70	432	290	185	180	19.5
76	81	483	320	225	220	29
82	92	559	375	280	240	35
90	105	610	410	280	250	42
120	120	660	450	280	280	58

C

Thimbles

Tubular type

- Material: mild steel
- Finish: painted
- Certification: 2.1



P-6190

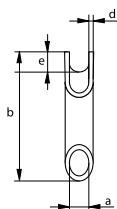
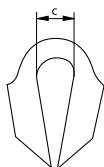

diameter wire rope	diameter	length	width inside	thickness	height	weight each
mm	a mm	b mm	c mm	d mm	e mm	kg
10	12	90	23	4	8	0.23
12	15	105	27	5	10	0.4
14	17	115	27	5	10	0.5
16	19	120	32	5	12	0.6
18	22	140	35	5	15	0.75
22	25	180	45	6	16	1.4
24	28	180	45	7	16	1.75
26	30	195	47	7	18	2
32	35	215	60	7	22	2.5
36	40	212	70	9	36	3
38	45	260	70	7	27	3.5
44	50	280	75	7	28	4.2

C

Thimbles

Tubular type with welded plate

- Material: mild steel
- Finish: painted
- Certification: 2.1



P-6195

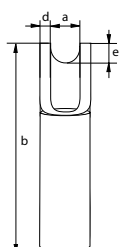
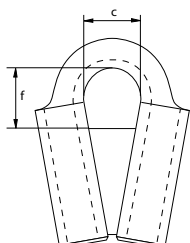

diameter wire rope	width groove	length	width inside	thickness	height	length inside	weight each
mm	a mm	b mm	c mm	d mm	e mm	f mm	kg
10	12	84	23	4	8	24	0.26
12	15	95	27	5	10	31	0.42
14	17	100	27	5	10	38	0.48
16	19	112	32	5	12	46	0.61
18	22	125	35	5	15	47	0.95
22	25	150	45	6	16	61	1.33
24	28	157	45	7	16	56	1.67
26	30	170	47	7	18	68	1.96
32	35	190	60	7	22	73	2.43
36	40	212	70	9	26	80	4.32
38	45	228	70	7	27	94	3.67

WIRE ROPE CLIPS



Applications

Wire rope clips are used on wire rope eye-loop connections or complete loops, end-to-end connections where socketing or splicing is not feasible or when a temporary joint is required.

Range

Green Pin® offers a wide range of wire rope clips in specifically standardized models such as EN 13411-5 and DIN wire rope clips. Van Beest also offers a wide range of other wire rope clips to complement the Green Pin® assortment.

Design

Green Pin® wire rope clips are drop forged and have a bridge with grooves to tighten the wire rope properly in the clip; the DIN wire rope clips have a malleable base, without grooves.

Wire rope clips are generally marked with:

- manufacturer's symbol - e.g. GP
- wire rope diameter in mm or inches - e.g. 13 or 1/2"
- traceability code - e.g. A1

Finish

The finish can be electro-galvanized or hot dipped galvanized.

Certification

Specific details of certificate availability can be found on each product page. Please verify your certification requirements with Green Pin® at the time of order.

Instructions for use

Wire rope clips should be inspected before use to ensure that:

- all markings are legible;
- a wire rope clip with the correct dimensions has been selected;
- the nuts or any other locking system cannot vibrate out of position;
- the wire rope clip is free from nicks, gouges and cracks;
- never modify, repair or reshape a wire rope clip by machining, welding, heating or bending as this may affect their performance.

The wire rope clip should be fitted to the wire rope as shown in below figures. The bridge of the wire rope clip should always be placed on the load bearing part of the rope. The U-bolt of the clip should be placed on the rope tail, also known as the dead end of the rope. Turn back enough wire rope length so that the required minimum number of clips can be installed according to the instructions below.

The first clip must be placed one bridge width from the turned-back rope tail or dead end of the rope, according to figure 1. Tighten the nuts to the specified torque.

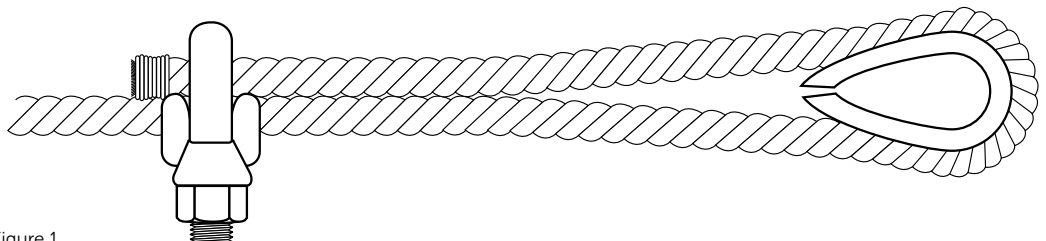

Figure 1

The second clip must be placed immediately against the thimble. Take care that the correct tightening of the clip does not damage the outer wires of the wire rope (figure 2). Tighten the nuts firmly but not yet to the specified torque.

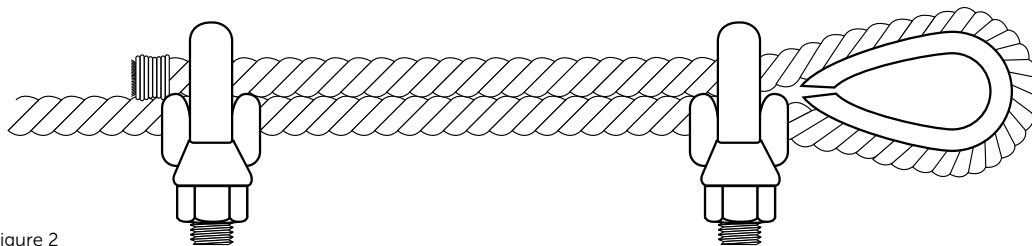

Figure 2

The following clips should be placed on the wire rope between the first and second clip in such a way that they are separated by at least 1½ times the clip-width with a maximum of 3 times the clip-width, according to figure 3.

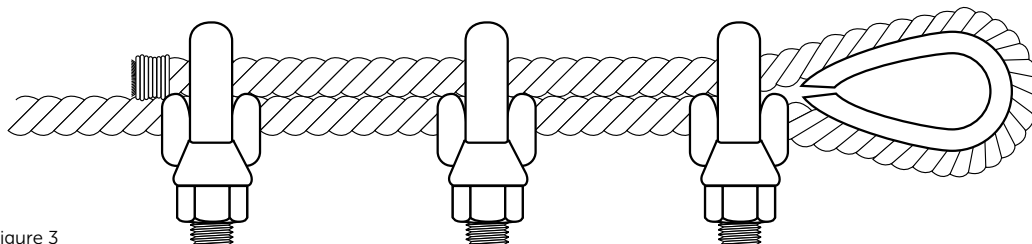

Figure 3

Apply light tension on the rope and tighten all nuts evenly, alternating until reaching the specified torque. After assembly and before the rope is taken into service, the nuts must be tightened further to the prescribed torque. After the load has been applied to the assembly for the first time, the torque value must be checked and corrected if necessary. Re-tightening of the nuts must be done at 10.000 cycles (heavy usage), 20.000 cycles (moderate usage) or 50.000 cycles (light usage). If cycles are unknown, a competent person could fix a time period, e.g. every 3 months, 6 months, annually.

The torque values and the minimum number of clips to be applied for a particular rope size are given in the following tables.

diameter wire rope inch	diameter wire rope mm	min. no of clips required	length of rope to turn back mm	torque value Nm	torque value Ft.Lbs
1/8	3 - 4	2	85	6.1	4.5
3/16	5	2	95	10.2	7.5
1/4	6 - 7	2	120	20.3	15
5/16	8	3	133	40.7	30
3/8	9 - 10	3	165	61	45
7/16	11	3	178	88	65
1/2	12 - 13	3	292	88	65
9/16	14 - 15	3	305	129	95
5/8	16	3	305	129	95
3/4	18 - 20	4	460	176	130
7/8	22	4	480	305	225
1	24 - 26	5	660	305	225
1 1/8	28 - 30	6	860	305	225
1 1/4	32 - 34	7	1120	488	360
1 3/8	36	7	1120	488	360
1 1/2	38 - 40	8	1370	488	360
1 5/8	41 - 42	8	1470	583	430
1 3/4	44 - 46	8	1550	800	590
2	48 - 52	8	1800	1017	750
2 1/4	56 - 58	8	1850	1017	750
2 1/2	62 - 65	9	2130	1017	750
2 3/4	68 - 72	10	2540	1017	750
3	75 - 78	10	2690	1627	1200

Table 1, Green Pin® wire rope clips generally to EN 13411-5 Type B, required number and torque value

diameter wire rope	min. no of clips required	torque value	torque value
mm		Nm	Ft.Lbs
5	3	2	1.5
6.5	3	3.5	2.6
8	4	6	4.4
10	4	9	6.6
12	4	20	14.8
13	4	33	24.3
14	4	33	24.3
16	4	49	36
19	5	68	50
22	5	107	79
26	5	147	108
30	6	212	156
34	6	296	218
40	6	363	268

Table 2, Wire rope clips generally to EN 13411-5 Type A, required number and torque value

The efficiency of a wire rope termination made with wire rope clips depends on the correct placement of the clips on the rope and on correct fitting and tightening of the clips. With inadequately tightened nuts or with an insufficient number of wire rope clips the rope end may slide through the clips during use.

The fitting of the clips on the ropes may be affected by various circumstances, such as:

- the nut may be tight on the thread, yet not tight against the bridge;
- contamination of the thread by dirt, oil or corrosion products, which may prevent correct tightening of the nut.

Forged wire rope clips provide greater bearing surface and more consistent strength than malleable cast iron clips.

Suitable applications of wire rope clips to EN 13411-5 standards include suspending static loads and single use lifting operations which have been assessed by a competent person taking into account appropriate safety factors.

Wire rope clips should not be used in following applications:

- hoist ropes in mines;
- rope drives for cranes in steel works and rolling mills;
- permanent fastening of ropes in other rope drives;
- rope terminations for load suspension devices in the operation of lifting appliances, except in the case of lifting tackles where these are produced for a special application and used only once.

Wire rope clips must be regularly inspected in accordance with the safety standards given in the country of use. This is required because the products in use may be affected by wear, misuse, overloading etc. which may lead to deformation and alteration of the material structure. Inspection should take place at least every six months and more frequently when the products are used in severe operating conditions.



Green Pin® Wire Rope Clip

Wire rope clip generally to EN 13411-5 Type B

- **Material:** bridge: drop forged high tensile steel SAE 1045
U-bolt: SAE 1015
- **Standard:** EN 13411-5 Type B
formerly U.S. Federal Specification FF-C-450D
- **Finish:** hot dipped galvanized
U-bolt and/or nuts for diameter bow 5, 6, 8 and 10 are electro galvanized
- **Certification:** 2.1

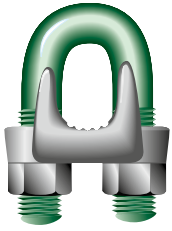

G-6240

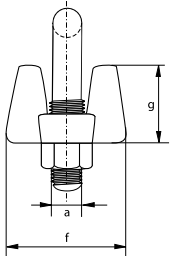
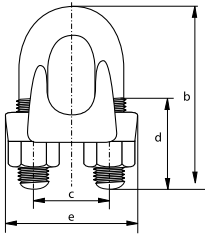

diameter wire rope	diameter	length bow	width inside	length thread	length base	thickness base	height base	weight per 100 pcs
mm	a mm	b mm	c mm	d mm	e mm	f mm	g mm	kg
3 - 4	5	24	12	11	24	21	10	2
5	6	31	15	13	29	24	13	4
6 - 7	8	34	19	13	37	30	18	8
8	10	45	22	19	43	33	19	14
9 - 10	11	49	26	19	49	42	25	19
11	12	60	30	25	58	46	26	31
12 - 13	13	61	30	25	58	48	31	34
14 - 15	14	72	33	32	63	52	31	36
16	14	74	33	32	64	54	36	45
18 - 20	16	86	38	37	72	57	38	68
22	19	98	45	41	80	62	40	108
24 - 26	19	108	48	46	88	67	47	113
28 - 30	19	117	51	51	91	73	48	140
32 - 34	22	130	59	54	105	79	56	207
36	22	140	60	59	108	79	58	234
38 - 40	22	147	66	60	112	85	64	266
41 - 42	25	161	70	67	121	92	67	329
44 - 46	29	174	78	70	134	97	76	441
48 - 52	32	195	86	78	150	113	85	603
56 - 58	32	213	98	81	162	116	100	707
62 - 65	32	227	105	87	168	119	113	806
68 - 72	32	243	112	91	174	127	124	1000
75 - 78	38	271	121	98	194	135	136	1440

In inch

diameter wire rope	diameter	length bow	width inside	length thread	length base	thickness base	height base	weight per 100 pcs
inch	a inch	b inch	c inch	d inch	e inch	f inch	g inch	lbs
1/8	3/16	15/16	15/32	7/16	15/16	13/16	13/32	4.4
3/16	1/4	1 7/32	19/32	1/2	1 5/32	15/16	1/2	8.8
1/4	5/16	1 11/32	3/4	1/2	1 15/32	1 3/16	23/32	17.6
5/16	13/32	1 25/32	7/8	3/4	1 11/16	1 5/16	3/4	28.7
3/8	7/16	1 15/16	1 1/32	3/4	1 15/16	1 21/32	31/32	42
7/16	15/32	2 3/8	1 3/16	31/32	2 9/32	1 13/16	1 1/32	73
1/2	1/2	2 13/32	1 3/16	31/32	2 9/32	1 7/8	1 7/32	75
9/16	9/16	2 27/32	1 5/16	1 1/4	2 15/32	2 1/16	1 7/32	99
5/8	9/16	2 29/32	1 5/16	1 1/4	2 17/32	2 1/8	1 13/32	99
3/4	5/8	3 3/8	1 1/2	1 15/32	2 27/32	2 1/4	1 1/2	150
7/8	3/4	3 27/32	1 25/32	1 5/8	3 3/32	2 7/16	1 9/16	238
1	3/4	4 1/4	1 7/8	1 13/16	3 15/32	2 5/8	1 7/8	249
1 1/8	3/4	4 19/32	2	2	3 19/32	2 7/8	1 7/8	309
1 1/4	7/8	5 1/8	2 5/16	2 1/8	4 1/8	3 1/8	2 7/32	456
1 3/8	7/8	5 1/2	2 3/8	2 5/16	4 1/4	3 1/8	2 9/32	516
1 1/2	7/8	5 25/32	2 19/32	2 3/8	4 13/32	3 11/32	2 17/32	560
1 5/8	31/32	6 11/32	2 3/4	2 5/8	4 3/4	3 5/8	2 5/8	725
1 3/4	1 5/32	6 27/32	3 1/16	2 3/4	5 9/32	3 13/16	3	972
2	1 1/4	7 11/16	3 3/8	3 1/16	5 29/32	4 7/16	3 11/32	1329
2 1/4	1 1/4	8 3/8	3 27/32	3 3/16	6 3/8	4 9/16	3 15/16	1559
2 1/2	1 1/4	8 15/16	4 1/8	3 7/16	6 5/8	4 11/16	4 7/16	1777
2 3/4	1 1/4	9 9/16	4 13/32	3 19/32	6 27/32	5	4 7/16	2238
3	1 1/2	10 21/32	4 3/4	3 27/32	7 5/8	5 5/16	5 11/32	3245

C

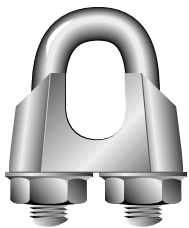

E-6260

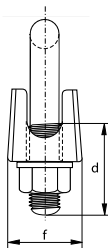
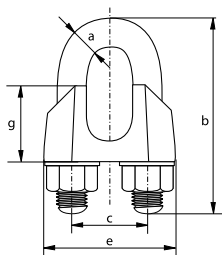

Wire Rope Clip

Generally to EN 13411-5 Type A

- **Material:** bridge: malleable steel
U-bolt: mild steel
- **Standard:** EN 13411-5 Type A
formerly DIN 1142
- **Finish:** electro-galvanized
- **Certification:** 2.1

diameter wire rope	diameter a	length bow b	width inside c	length thread d	length base e	thickness base f	height base g	weight per 100 pcs
mm	mm	mm	mm	mm	mm	mm	mm	kg
5	5	25	12	14	25	13	13	2
6.5	6	32	14	17	30	16	14	4
8	8	41	18	20	39	20	18	8.2
10	8	46	20	24	40	20	21	8.4
12	10	56	24	28	50	25	24	17
13	12	64	29	29	55	28	29	27.5
14	12	66	28	31	59	30	28	28.6
16	14	76	34	35	64	32	35	43
19	14	83	37	36	68	33	40	49
22	16	96	41	40	74	34	44	68
26	20	111	46	50	84	38	51	111
30	20	127	54	55	95	41	59	140
34	22	141	60	60	105	45	67	202
40	24	159	68	65	117	49	77	268

C

Wire Rope Clip

Generally to DIN 741



E-6220

- **Material:** bridge: casted
U-bolt: mild steel
- **Standard:** formerly DIN 741
- **Finish:** electro-galvanized
- **Certification:** 2.1

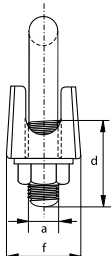
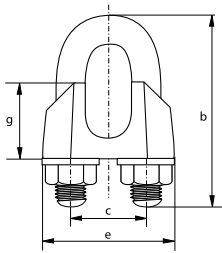

diameter wire rope	diameter	length bow	width inside	length thread	length base	thickness base	height base	weight per 100 pcs
mm	a mm	b mm	c mm	d mm	e mm	f mm	g mm	kg
3	4	20	9	12	21	10	10	1.4
5	5	24	11	13	23	11	10	1.5
6	5	28	13	15	26	12	11	1.6
8	6	34	16	19	30	14	15	4.1
10	8	42	19	22	34	18	17	6
11	8	44	20	22	36	19	18	7
13	10	55	24	30	42	23	21	11.8
14	10	57	25	30	44	23	22	12.4
16	12	63	29	33	50	26	26	21
19	12	75	32	38	54	29	30	23.6
22	14	85	37	44	61	33	34	23.8
26	14	95	41	45	65	35	37	41
30	16	110	48	50	74	37	43	62
34	16	120	52	55	80	42	50	75
40	16	140	58	60	88	45	55	104
45	18	163	65	75	97	49	60	134
50	20	170	72	77	106	51	65	175

SLEEVES



Applications

Sleeves are used to create loop ends on wire rope slings. They are available in two types and in various sizes.

Range

Van Beest offers a wide range of sleeves in aluminium and carbon steel to complement the Green Pin® assortment.

Design

Aluminium wire rope sleeves are manufactured according to DIN 3093 A. For safety during fabrication and application they are of seamless construction. Prescon carbon steel sleeves are manufactured from carbon steel. They include the Swaging Verification System, in which the colour intensity changes after swaging. This system helps the sling manufacturer to determine whether or not the sleeve has been pressed. The sleeves are of seamless construction and fit industry standard dies.

Finish

Aluminium sleeves are self coloured. The smaller dimensions of Prescon sleeves (up to and including 16 mm) are colour coded, larger dimensions are self coloured.

Certification

Specific details of certificate availability can be found on each product page. Please verify your certification requirements at the time of order.

Instructions for use

For Aluminium sleeves, please refer to EN 13411-3. Prescon sleeves are recommended for use with 6 x 19 or 6 x 37 IPS or XIP (EIP), RRL, FC, or IWRC wire rope. After creating a loop end multiple progressive pressings are required to prevent flash, which will develop into a permanent mark or possibly a crack in the sleeve. A light oil lubricant should be applied to each die before pressing. The sleeve must be cleaned after the swaging operation to stimulate effective colour change. Colour change is not an indication for proper swaging, only an indication that the sleeve has been pressed. Proper swaging practices are the sling manufacturer's responsibility. Before using sleeves with other type lay, construction or grade of wire rope, it is recommended that the termination be proof loaded to prove the adequacy of the assembly. Regular inspection of the swaging machine, dies etc. must be conducted to ensure that the equipment continues to meet required standards.

C

Prescon sleeves

For wire rope

- **Material:** special carbon steel
- **Finish:** up to and including size 16 mm colour coded
sizes above 16 mm self coloured
- **Certification:** 2.1



S-6500

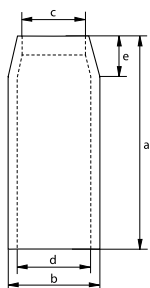

diameter wire rope	length	diameter outside	diameter inside	diameter inside	length	diameter outside pressed	weight per 100 pcs
mm	a mm	b mm	c mm	d mm	e mm	mm	kg
6	25.4	16.7	8.3	11.9	7.1	12.7	2.15
8	38.1	23	11.1	15.5	11.1	18.5	6.5
10	38.1	23	11.9	16.7	11.1	18.5	5.5
11	51	31	14.3	21.4	15.1	24.9	11.3
13	51	31	15.9	23	15.1	24.9	12.5
14	70	37	17.5	26.2	17.9	30.5	19.5
16	70	37	19.1	27.8	17.9	30.5	25.9
19	81	43.6	23.4	32.5	21.8	35.8	39.9
22	90	51.6	26.2	38.9	25.4	41.4	62
25	102	58	29.4	43.7	28.6	47.8	85
28	122	64	32.5	49.2	31.8	53	118
32	132	71	36.5	55	35.7	58	154
34 - 35	148	76	39.7	60	39.7	62	195
37 - 38	159	83	42.9	66.7	42.9	67	227
44 - 45	184	102	49.2	79	50	77	367
50 - 52	216	111	57	92	57	89	510
56 - 57	243	128	64	102	64	103	862
62 - 64	267	140	70	114	71	113	1043
68 - 70	292	146	76	121	79	118	1270
75 - 76	305	152	83	127	86	124	1334
87 - 89	356	178	98	148	100	145	2105
93 - 95	381	191	103	160	108	156	2495
100 - 102	406	206	111	173	114	180	3130
112 - 114	457	232	124	194	129	187	4536

C



A-6550

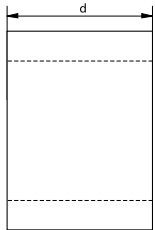
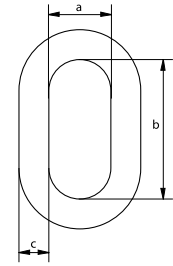

Aluminium sleeves

For wire rope

- **Material:** aluminium
- **Standard:** EN 13411-3 formerly DIN 3093 A
- **Finish:** self coloured
- **Certification:** 2.1

size	diameter	width	thickness	length	weight per 1000 pcs
	a mm	b mm	c mm	d mm	kg
1	1.2	2.4	0.65	5	0.1
1.5	1.7	3.4	0.75	6	0.21
2	2.2	4.4	0.85	7	0.24
2.5	2.7	5.4	1.05	9	0.5
3	3.3	6.6	1.25	11	0.84
3.5	3.8	7.6	1.5	13	1.32
4	4.4	8.8	1.7	14	2
4.5	4.9	9.8	1.9	16	2.61
5	5.5	11.0	2.1	18	5
6	6.6	13.2	2.5	21	5
6.5	7.2	14.4	2.7	23	7.55
7	7.8	15.6	2.9	25	9.53
8	8.8	17.6	3.3	28	15
9	9.9	19.8	3.7	32	19.8
10	10.9	21.8	4.1	35	25
11	12.1	24.2	4.5	39	35.8
12	13.2	26.4	4.9	42	45.8
13	14.2	28.4	5.4	46	59.7
14	15.3	30.6	5.8	49	73.5
16	17.5	35.0	6.7	56	111
18	19.6	39.2	7.6	63	159
20	21.7	43.4	8.4	70	220
22	24.3	48.6	9.2	77	280
24	26.4	52.8	10.0	84	376
26	28.5	57.0	10.9	91	481
28	31.0	62.0	11.7	98	603
30	33.1	66.2	12.5	105	735
32	35.2	70.4	13.4	112	897
34	37.8	75.6	14.2	119	1080
36	39.8	79.6	15.0	126	1275
38	41.9	83.8	15.8	133	1490
40	44.0	88.0	16.6	140	1734
42	46.2	92.4	17.5	147	1940
44	48.4	96.8	18.3	154	2314
46	50.6	101.2	19.2	161	2557
48	52.8	105.6	20.0	168	3010
50	55.0	110.0	20.8	175	3400
52	57.2	114.4	21.6	182	3813
54	59.4	118.8	22.5	189	4120
56	61.6	123.2	23.3	196	4772
58	63.8	127.6	24.2	203	5200
60	66.0	132.0	25.0	210	5880

EN 13411-3 Table A.2 - Ferrule size numbers

Rope diameter			Ferrule size number			
			Case 1	Case 2	Case 3	Case 4
			single layer round strand ropes with FC and cable laid ropes $C^* \geq 0,283$	single layer round strand ropes with IWRC and rotation-resistant round strand ropes $C^* \leq 0,487$	single layer round strand ropes with IWRC, rotation-resistant ropes and parallel-closed ropes $0,487 < C^* \leq 0,613$	spiral strands 2 ferrules $C^* \leq 0,613$
Nominal	Measured					
d	from	to				
mm	mm	mm				
2.5	2.5	2.7	2.5	3	-	-
3	2.8	3.2	3	3.5	-	-
3.5	3.3	3.7	3.5	4	-	-
4	3.8	4.3	4	4.5	-	5
4.5	4.4	4.8	4.5	5	-	6
5	4.9	5.4	5	6	-	6.5
6	5.5	5.9	6	6.5	-	7
	6	6.4			7	
6.5	6.5	6.9	6.5	7	8	8
7	7	7.4	7	8	9	9
8	7.5	7.9	8	9	9	10
	8	8.4			10	
9	8.5	8.9	9	10	10	11
	9	9.5			11	
10	9.6	9.9	10	11	11	12
	10	10.5			12	
11	10.6	10.9	11	12	12	13
	11	11.6			13	
12	11.7	11.9	12	13	13	14
	12	12.6			14	
13	12.7	12.9	13	14	14	16
	13	13.7			16	
14	13.8	13.9	14	16	16	18
	14	14.7			18	
16	14.8	15.9	16	18	18	20
	16	16.8			20	
18	16.9	17.9	18	20	20	22
	18	18.9			22	
20	19	19.9	20	22	22	24
	20	21			24	
22	21.1	21.9	22	24	24	26
	22	23.1			26	
24	23.2	23.9	24	26	26	28
	24	25.2			28	
26	25.3	25.9	26	28	28	30
	26	27.3			30	
28	27.4	27.9	28	30	30	32
	28	29.4			32	
30	29.5	29.9	30	32	32	34
	30	31.5			34	
32	31.6	31.9	32	34	34	36
	32	33.6			36	
34	33.7	33.9	34	36	36	38
	34	35.7			38	
36	35.8	35.9	36	38	38	40
	36	37.8			40	
38	37.9	37.9	38	40	40	44
	38	39.9			44	
40	40	42	40	44	48	48
44	42.1	43.9	44	48	48	48
	44	46.2			52	
48	46.3	47.9	48	52	52	52
	48	50.4			56	
52	50.5	51.9	52	56	56	60
	52	54.6			60	
56	54.7	55.9	56	60	-	-
	56	58.8			-	
60	58.9	59.9	60	-	-	-
	60	63		-		

* for metallic cross-sectional area factor C refer to EN 12385 parts 4, 5 & 10

SOCKETS



Applications

Sockets are used as a connection to attach steel wire rope to a fixed point. This may be an anchoring system for tubes or pipes, anchor wires for dredging materials, anchor cables for oil platforms, fastening points for towing cables or for fastening cables in constructions such as bridges, roofs etc. Sockets are designed for in-line use only. Sockets are the strongest steel wire rope end fittings available. If they are assembled in the proper way they meet or exceed the breaking strength of the steel wire rope.

Range

Green Pin® offers a wide range of socket types in various sizes and shapes.

Design

Green Pin® open- and closed spelter sockets and Green Pin® open wedge sockets are made from cast high tensile steel.

These sockets are generally marked with:

- manufacturer's symbol - e.g. GP
- wire rope diameter in mm and inches - e.g. 20-22 and 7/8"
- traceability code - e.g. A01
- socket number - e.g. 104

Swage sockets are drop forged from special bar quality carbon steel C-1035 and spheroidized annealed to make them suitable for cold swaging.

Finish

Green Pin® open- and closed spelter sockets and open wedge sockets are galvanized. Swage sockets are self coloured.

Certification

Specific details of certificate availability can be found on each product page. Please verify your certification requirements at the time of order.

Instructions for use

1) Open spelter sockets – closed spelter sockets

In the past melted zinc was poured into the sockets to fix the steel wire rope; nowadays resins are used for this purpose.

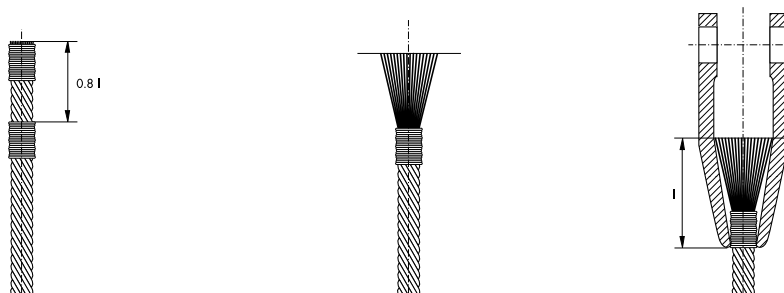

Figure 1

- brooming is done after the wire rope has been placed into the socket;
- when using resins always exactly follow the instructions given by the manufacturer carefully;
- socketing must be done by specialists in a certified sling shop.

2) Open wedge sockets

The wedge and body act as a vice which grips the wire rope and locks it in place. Green Pin® wedge sockets may be used within the range of wire rope diameters as shown in the table further on in the catalogue.

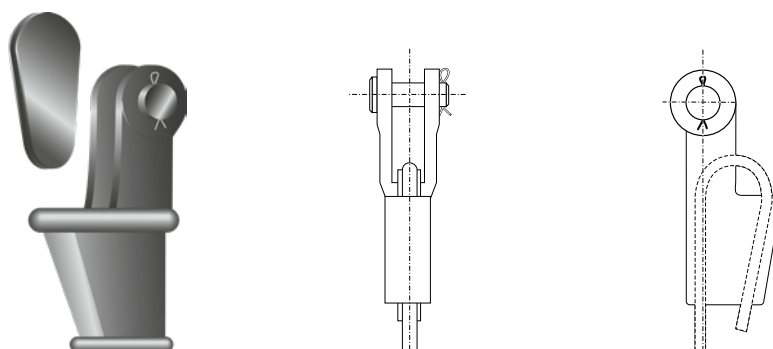

Figure 2

When using open wedge sockets the following precautions should be taken:

- before use always inspect the socket, the wedge and the pin;
- use only with standard 6-8 strand wire rope;
- always be sure that socket and wedge have the correct size for the wire rope diameter;
- the loaded part of the steel wire rope should be mounted in the centre line of the pin;
- when installing the wire rope, always pre-load the wedge with the wire rope in place;
- never weld the tail; the tail should have a length of at least 6 times the wire rope diameter with a minimum of 150 mm. Secure the dead end of the rope with a wire rope clip as shown in figure 3;
- before applying the first load always use a hammer to seat the wedge and rope into the socket as deep as possible;
- check the assembly regularly; re-tighten or re-position if necessary;
- never side load a wedge socket as it has not been designed for that purpose;
- load may slip if the connection is not properly installed;
- the efficiency of a wire rope - wedge socket connection is 80% of the minimum breaking load of the wire, but is limited to the minimum breaking load of the socket;
- only use the original wedge supplied by the manufacturer of the socket and be sure it is suitable for the diameter of the rope used;
- never use a wedge from any other supplier than the original socket supplier as the dimensions will not match.

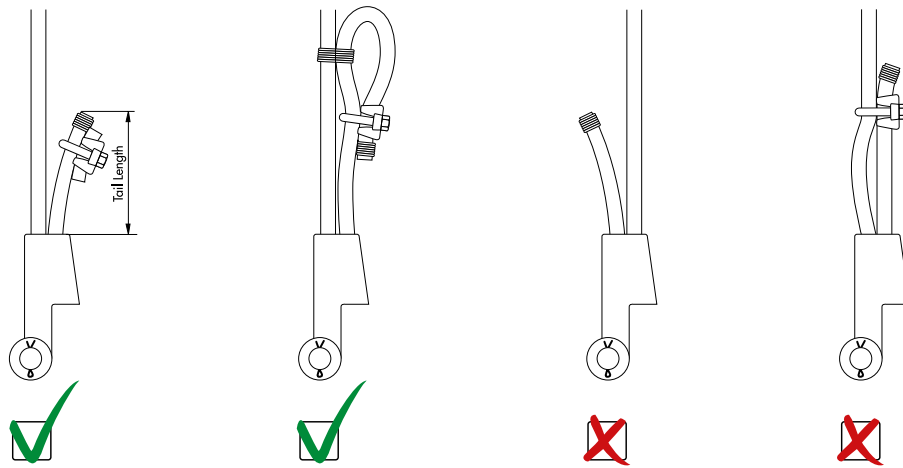

Figure 3

3) Swage sockets

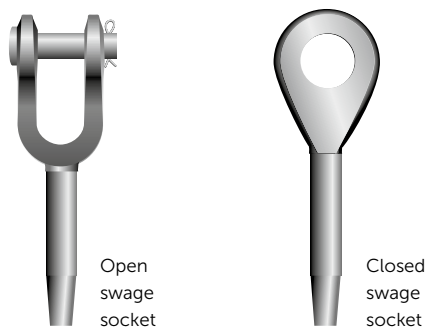

Figure 4

Swage Sockets are recommended for use on 6 x 19 or 6 x 37 IPS or XIP (EIP), XXIP (EEIP), RRL, FC, or IWRC wire ropes. They are also approved for use on galvanized bridge rope. Before using swage socket assemblies, it is recommended that the termination be proof loaded to prove the adequacy of the assembly. Always swage under supervision of a specialist from a certified sling shop.

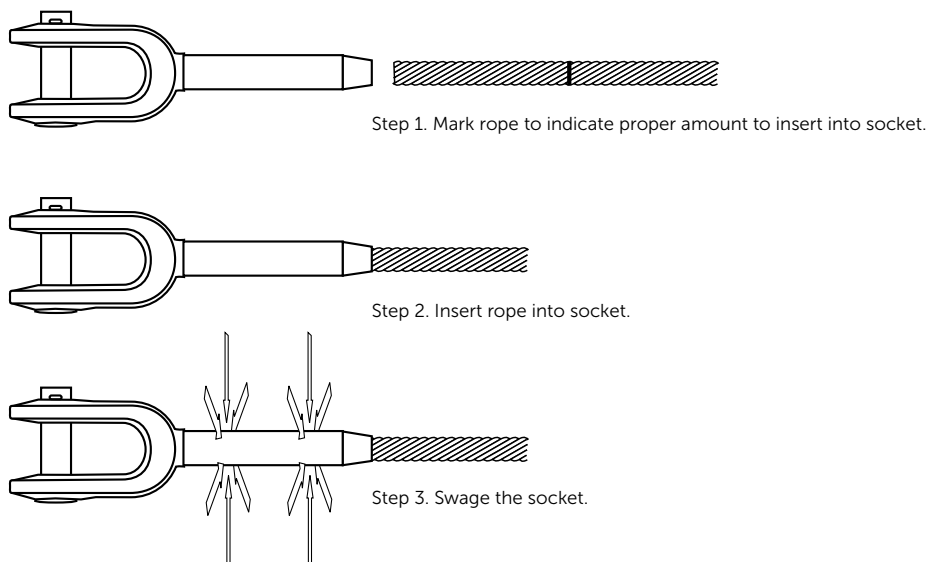

Figure 5

INFO

For more instructions on swaging we refer to the swaging instruction (PI-03-14 in the FAQ section) on our website.

Sockets must be regularly inspected in accordance with the safety standards given in the country of use. This is required because the products in use may be affected by wear, misuse, overloading etc. which may lead to deformation and alteration of the material structure. Inspection should take place at least every six months and more frequently when the sockets are used in severe operating conditions.



Green Pin® Closed Spelter Socket

- **Material:** high tensile steel
- **Finish:** hot dipped galvanized
- **Temperature Range:** -20°C up to +200°C
- **Certification:** 2.1 2.2 3.1 CE



G-6411

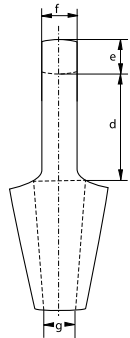
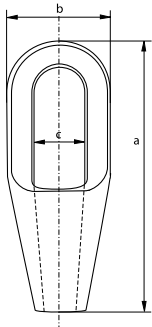

number	minimum breaking load	diameter wire rope	length	width	width inside bow	length inside bow	thickness bow	thickness bow	opening	weight each
	t	mm	a mm	b mm	c mm	d mm	e mm	f mm	g mm	kg
296	8	6 - 7	101	37	22	40	11	13	9	0.3
297	12	8 - 10	119	43	25	48	14	17.5	12	0.5
298	20	11 - 13	140	52	30	58	18	23.5	15	0.75
299	25	14 - 16	162	68	37	66	21	26	17.5	1.5
200	40	18 - 19	194	76	42	78	27	32	21.5	2.4
201	55	20 - 22	224	92	47	90	33	38	24	3.6
204	75	23 - 26	253	104	57	103	36	44	28	5.8
207	90	27 - 30	282	114	63	116	39	51	32	7
212	125	31 - 36	312	127	70	130	43	57	38	10.5
215	150	37 - 39	358	136	79	155	51	63	41	13
217	170	40 - 42	390	146	83	171	54	70	44	17
219	225	43 - 48	443	171	93	198	55	76	51	26
222	280	49 - 54	502	193	100	224	62	82	57	37.5
224	360	55 - 60	548	216	112	247	73	92	63	50
226	425	61 - 68	597	241	140	270	79	102	73	65
227	460	69 - 75	644	273	159	286	79	124	79	94
228	560	76 - 80	686	292	171	298	83	133	86	115
229	625	81 - 86	743	311	184	311	102	146	92	145
230	720	87 - 93	788	330	197	330	102	159	99	168
231	875	94 - 102	845	362	216	356	108	178	108	210
233	1200	108 - 115	1000	405	235	425	125	190	125	330
240	1300	120 - 130	1150	450	260	525	125	200	143	500

In inch

number	minimum breaking load	diameter wire rope	length	width	width inside bow	length inside bow	thickness bow	thickness bow	opening	weight each
	t	inch	a inch	b inch	c inch	d inch	e inch	f inch	g inch	lbs
296	8	1/4	3 31/32	1 1/2	7/8	1 19/32	7/16	1/2	11/32	0.66
297	12	3/8	4 11/16	1 23/32	1	1 29/32	9/16	11/16	15/32	1.10
298	20	7/16 - 1/2	5 17/32	2 1/32	1 3/16	2 9/32	23/32	15/16	19/32	1.54
299	25	9/16 - 5/8	6 11/32	2 11/16	1 1/2	2 19/32	13/16	1 1/32	11/16	3.31
200	40	3/4	7 5/8	3	1 11/16	3 3/32	1 3/32	1 9/32	27/32	5.29
201	55	7/8	8 13/16	3 5/8	1 7/8	3 9/16	1 5/16	1 17/32	15/16	7.94
204	75	1	9 31/32	4 3/32	2 1/4	4 1/32	1 7/16	1 3/4	1 1/8	12.79
207	90	1 1/8	11 1/8	4 1/2	2 1/2	4 9/16	1 9/16	2	1 9/32	15.43
212	125	1 1/4 - 1 3/8	12 9/32	5	2 3/4	5 1/8	1 23/32	2 1/4	1 17/32	23.1
215	150	1 1/2	14 3/32	5 11/32	3 1/8	6 3/32	2	2 1/2	1 5/8	28.7
217	170	1 5/8	15 11/32	5 3/4	3 9/32	6 23/32	2 1/8	2 3/4	1 3/4	37.5
219	225	1 3/4 - 1 7/8	17 1/2	6 23/32	3 11/16	7 25/32	2 5/32	3	2	57.3
222	280	2 - 2 1/8	19 25/32	7 19/32	3 15/16	8 13/16	2 7/16	3 1/4	2 1/4	82.7
224	360	2 1/4 - 2 3/8	21 19/32	8 17/32	4 3/8	9 3/4	2 7/8	3 5/8	2 1/2	110.2
226	425	2 1/2 - 2 5/8	23 17/32	9 17/32	5 17/32	10 5/8	3 1/8	4	2 7/8	143.3
227	460	2 3/4 - 2 7/8	25 11/32	10 3/4	6 1/4	11 9/32	3 1/8	4 7/8	3 1/8	207.2
228	560	3 - 3 1/8	27	11 17/32	6 23/32	11 3/4	3 9/32	5 1/4	3 3/8	254
229	625	3 1/4 - 3 3/8	29 1/4	12 1/4	7 1/4	12 1/4	4	5 3/4	3 5/8	320
230	720	3 1/2 - 3 5/8	31	13	7 3/4	13	4	6 1/4	3 29/32	370
231	875	3 3/4 - 4	33 9/32	14 1/4	8 17/32	14	4 1/4	7	4 1/4	463
233	1200	4 1/4 - 4 1/2	39 3/8	15 15/16	9 9/32	16 3/4	4 29/32	7 1/2	4 29/32	728
240	1300	4 3/4 - 5	45 9/32	17 3/4	10 1/4	20 11/16	4 29/32	7 7/8	5 5/8	1102





Green Pin® Open Spelter Socket CP

Open spelter socket with cotter pin

- **Material:** high tensile steel
- **Finish:** hot dipped galvanized
- **Temperature Range:** -20°C up to +200°C
- **Certification:** 2.1 2.2 3.1 CE

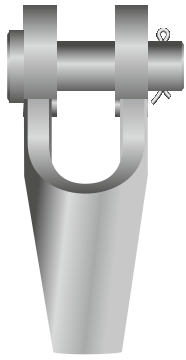

G-6412

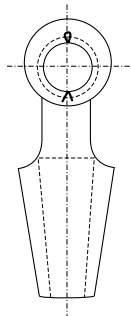
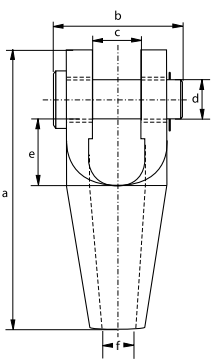

number	minimum breaking load	diameter wire rope	length	width	width inside	diameter pin	length inside	opening	weight each
	t	mm	a mm	b mm	c mm	d mm	e mm	f mm	kg
196	8	6 - 7	109	51	19	16	33	9	0.4
197	12	8 - 10	124	62	21	21	34	12	0.7
198	20	11 - 13	143	66	26	25	37	15	1
199	25	14 - 16	172	82	33	30	49	18	1.8
100	40	18 - 19	205	95	38	35	58	21	3
104	55	20 - 22	235	110	44	41	68	24	4.6
108	75	23 - 26	275	130	51	51	75	28	8
111	90	27 - 30	306	144	57	57	85	32	11
115	125	31 - 36	338	155	63	64	95	38	16
118	150	37 - 39	394	178	76	70	127	41	22
120	170	40 - 42	418	187	76	76	127	44	27
125	225	43 - 48	468	213	89	89	134	51	41
128	280	49 - 54	552	240	101	95	181	57	64
130	360	55 - 60	598	270	113	108	196	63	88
132	425	61 - 68	654	303	127	121	213	73	125
135	460	69 - 75	696	349	133	127	216	79	155
138	560	76 - 80	737	371	146	133	220	86	187
140	625	81 - 86	788	391	159	140	228	92	230
142	720	87 - 93	852	411	171	152	242	99	265
144	875	94 - 102	914	447	191	178	254	108	400
146	1200	108 - 115	1160	489	206	193	369	125	660

In inch

number	minimum breaking load	diameter wire rope	length	width	width inside	diameter pin	length inside	opening	weight each
	t	inch	a inch	b inch	c inch	d inch	e inch	f inch	lbs
196	8	1/4	4 9/32	2	3/4	5/8	1 5/16	11/32	0.88
197	12	3/8	4 7/8	2 7/16	13/16	13/16	1 11/32	15/32	1.54
198	20	7/16 - 1/2	5 5/8	2 19/32	1 1/32	1	1 1/2	19/32	2.20
199	25	9/16 - 5/8	6 3/4	3 1/4	1 5/16	1 3/16	1 15/16	23/32	3.97
100	40	3/4	8 3/32	3 3/4	1 17/32	1 3/8	2 9/32	13/16	6.61
104	55	7/8	9 9/32	4 5/16	1 3/4	1 5/8	2 11/16	15/16	10.14
108	75	1	10 13/16	5 1/8	2	2	2 15/16	1 1/8	17.64
111	90	1 1/8	12 1/32	5 11/16	2 1/4	2 1/4	3 11/32	1 9/32	24.3
115	125	1 1/4 - 1 3/8	13 5/16	6 3/32	2 1/2	2 17/32	3 3/4	1 17/32	35.3
118	150	1 1/2	15 17/32	7	3	2 3/4	5	1 5/8	48.5
120	170	1 5/8	16 1/2	7 11/32	3	3	5	1 3/4	59.5
125	225	1 3/4 - 1 7/8	18 7/16	8 3/8	3 17/32	3 17/32	5 9/32	2	90.4
128	280	2 - 2 1/8	21 3/4	9 1/2	3 31/32	3 3/4	7 1/8	2 1/4	141.1
130	360	2 1/4 - 2 3/8	23 9/16	10 5/8	4 7/16	4 1/4	7 23/32	2 1/2	194
132	425	2 1/2 - 2 5/8	25 3/4	11 15/16	5	4 3/4	8 3/8	2 7/8	276
135	460	2 3/4 - 2 7/8	27 3/8	13 3/4	5 1/4	5	8 17/32	3 1/8	342
138	560	3 - 3 1/8	29	14 19/32	5 3/4	5 1/4	8 11/16	3 3/8	412
140	625	3 1/4 - 3 3/8	31	15 3/8	6 1/4	5 17/32	9	3 5/8	507
142	720	3 1/2 - 3 5/8	33 9/16	16 3/16	6 23/32	5 31/32	9 9/16	3 29/32	584
144	875	3 3/4 - 4	35 31/32	17 5/8	7 17/32	7	10	4 1/4	882
146	1200	4 1/4 - 4 1/2	45 11/16	19 9/32	8 1/8	7 19/32	14 17/32	4 29/32	1455

CAD



Green Pin® Open Spelter Socket BN

Open spelter socket with safety bolt

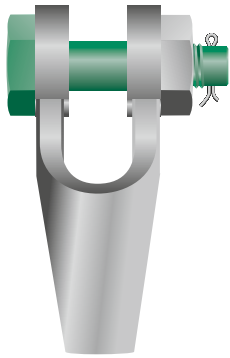

G-6422

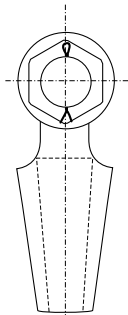
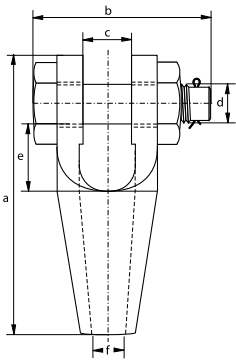

- **Material:** high tensile steel
- **Finish:** hot dipped galvanized
- **Temperature Range:** -20°C up to +200°C
- **Certification:** 2.1 2.2 3.1 CE

number	minimum breaking load	diameter wire rope	length	width	width inside	diameter pin	length inside	opening	weight each
	t	mm	a mm	b mm	c mm	d mm	e mm	f mm	kg
196	8	6 - 7	109	69	19	16	33	9	0.4
197	12	8 - 10	124	83	21	20	35	12	0.8
198	20	11 - 13	143	101	26	25	37	15	1.3
199	25	14 - 16	172	124	33	30	49	18	2.3
100	40	18 - 19	205	138	38	35	58	21	3.7
104	55	20 - 22	235	148	44	41	68	24	4.6
108	75	23 - 26	275	176	51	50	76	28	9.7
111	90	27 - 30	306	193	57	57	85	32	13.6
115	125	31 - 36	338	210	63	63	96	38	16
118	150	37 - 39	394	230	76	70	127	41	26.9
120	170	40 - 42	418	244	76	77	126	44	32

In inch

number	minimum breaking load	diameter wire rope	length	width	width inside	diameter pin	length inside	opening	weight each
	t	inch	a inch	b inch	c inch	d inch	e inch	f inch	lbs
196	8	1/4	4 9/32	2 23/32	3/4	5/8	1 5/16	11/32	0.88
197	12	3/8	4 7/8	3 9/32	13/16	25/32	1 3/8	15/32	1.76
198	20	7/16 - 1/2	5 5/8	3 31/32	1 1/32	1	1 1/2	19/32	2.87
199	25	9/16 - 5/8	6 3/4	4 7/8	1 5/16	1 3/16	1 15/16	23/32	5.07
100	40	3/4	8 3/32	5 7/16	1 17/32	1 3/8	2 9/32	13/16	8.16
104	55	7/8	9 9/32	5 13/16	1 3/4	1 5/8	2 11/16	15/16	10.14
108	75	1	10 13/16	6 29/32	2	1 31/32	3	1 1/8	21.38
111	90	1 1/8	12 1/32	7 19/32	2 1/4	2 1/4	3 11/32	1 9/32	30.0
115	125	1 1/4 - 1 3/8	13 5/16	8 9/32	2 1/2	2 1/2	3 25/32	1 17/32	35.3
118	150	1 1/2	15 17/32	9 3/32	3	2 3/4	5	1 5/8	59.3
120	170	1 5/8	16 1/2	9 5/8	3	3 1/32	4 15/16	1 3/4	70.5

CAD



Green Pin® Open Wedge Socket CP

Open wedge socket with cotter pin



G-6413

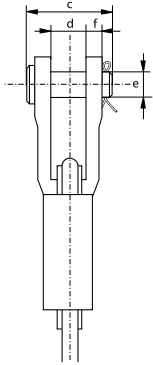
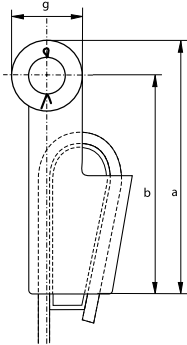

- **Material:** high tensile steel
- **Standard:** generally to EN 13411-6
- **Finish:** hot dipped galvanized
- **Temperature Range:** -20°C up to +200°C
- **Certification:** 2.1 2.2 3.1 CE

number	minimum breaking load	diameter wire rope	length	length to center pin	width	width inside	diameter pin	thickness side plates	diameter eye	weight each
	t	mm	a mm	b mm	c mm	d mm	e mm	f mm	g mm	kg
0.25	8	7 - 8	128	110	51	18	16	9	36	0.8
0.5	12	9 - 10	165	142	62	20.5	21	11	46	1.5
1	20	11 - 13	175	146	66	25	25	12	57	2.4
2	25	14 - 16	211	176	82	31	30	15	70	4
3	40	18 - 19	252	212	95	38	35	16	80	7.4
4	55	20 - 22	288	240	110	44	41	19	95	11
5	75	24 - 26	329	274	130	51	51	22	110	16
6	90	27 - 29	375	310	144	57	57	25	130	22
7	110	30 - 32	423	350	155	63	64	28	146	31
8	125	34 - 36	474	400	163	69	64	28	148	39
9	150	37 - 39	527	450	178	76	70	30	153	48
10	170	40 - 42	580	500	187	76	76	33	160	64
11	225	43 - 48	650	550	226	89	89	39	186	96
12	280	49 - 52	745	640	240	101	95	46	194	130
13	360	54 - 58	785	660	275	114	108	54	230	180
14	425	60 - 66	970	835	300	127	121	60	250	275
15	460	72 - 78	1150	1000	355	146	133	76	270	440
16	625	81 - 86	1252	1100	375	159	140	79	300	510

In inch

number	minimum breaking load	diameter wire rope	length	length to center pin	width	width inside	diameter pin	thickness side plates	diameter eye	weight each
	t	inch	a inch	b inch	c inch	d inch	e inch	f inch	g inch	lbs
0.25	8	5/16	5 1/32	4 5/16	2	23/32	5/8	11/32	1 7/16	1.76
0.5	12	3/8	6 1/2	5 19/32	2 7/16	13/16	13/16	7/16	1 13/16	3.31
1	20	1/2	6 7/8	5 3/4	2 19/32	1	1	15/32	2 1/4	5.29
2	25	5/8	8 5/16	6 29/32	3 1/4	1 1/4	1 3/16	19/32	2 3/4	8.82
3	40	3/4	9 15/16	8 11/32	3 3/4	1 17/32	1 3/8	5/8	3 5/32	16.31
4	55	7/8	11 11/32	9 1/2	4 5/16	1 3/4	1 5/8	3/4	3 3/4	24.3
5	75	1	12 15/16	10 25/32	5 1/8	2	2	7/8	4 5/16	35.3
6	90	1 1/8	14 3/4	12 3/16	5 11/16	2 1/4	2 1/4	1	5 1/8	48.5
7	110	1 1/4	16 11/16	13 25/32	6 3/32	2 1/2	2 17/32	1 1/8	5 3/4	68.3
8	125	1 3/8	18 11/16	15 3/4	6 3/8	2 23/32	2 17/32	1 1/8	5 13/16	86.0
9	150	1 1/2	20 3/4	17 3/4	7	3	2 3/4	1 3/16	6	105.8
10	170	1 5/8	22 13/16	19 23/32	7 11/32	3	3	1 5/16	6 9/32	141.1
11	225	1 3/4 - 1 7/8	25 19/32	21 11/16	8 29/32	3 17/32	3 17/32	1 9/16	7 5/16	212
12	280	2	29 5/16	25 3/16	9 1/2	3 31/32	3 3/4	1 13/16	7 5/8	287
13	360	2 1/4	30 7/8	25 31/32	10 13/16	4 1/2	4 1/4	2 1/8	9 3/32	397
14	425	2 1/2	38 5/32	32 7/8	11 13/16	5	4 3/4	2 11/32	9 7/8	606
15	460	3	45 9/32	39 3/8	13 31/32	5 3/4	5 1/4	3	10 5/8	970
16	625	3 1/4 - 3 3/8	49 5/16	43 5/16	14 3/4	6 1/4	5 17/32	3 1/8	11 13/16	1124

CAD



Green Pin® Open Wedge Socket BN

Open wedge socket with safety bolt



G-6423

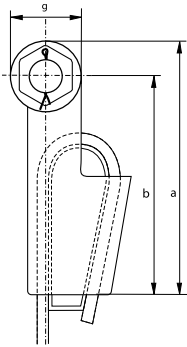

- **Material:** high tensile steel
- **Standard:** generally to EN 13411-6
- **Finish:** hot dipped galvanized
- **Temperature Range:** -20°C up to +200°C
- **Certification:** 2.1 2.2 3.1 CE

number	minimum breaking load	diameter wire rope	length	length to center pin	width	width inside	diameter pin	thickness side plates	diameter eye	weight each
	t	mm	a mm	b mm	c mm	d mm	e mm	f mm	g mm	kg
0.25	8	7 - 8	128	110	69	18	16	9	36	0.8
0.5	12	9 - 10	165	142	83	20.5	20	11	46	1.5
1	20	11 - 13	175	146	101	25	25	12	57	2.4
2	25	14 - 16	211	176	124	31	30	15	70	4.8
3	40	18 - 19	252	212	138	38	35	16	80	8.3
4	55	20 - 22	288	240	148	44	41	19	95	11
5	75	24 - 26	329	274	176	51	50	22	110	17.9
6	90	27 - 29	375	310	193	57	57	25	130	21
7	110	30 - 32	423	350	210	63	63	28	146	33
8	125	34 - 36	474	400	216	69	65	28	148	42
9	150	37 - 39	527	450	230	76	70	30	153	52
10	170	40 - 42	580	500	244	76	77	33	160	73

In inch

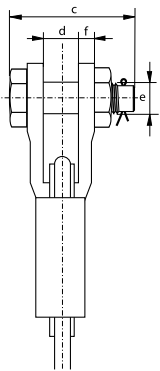

number	minimum breaking load	diameter wire rope	length	length to center pin	width	width inside	diameter pin	thickness side plates	diameter eye	weight each
	t	inch	a inch	b inch	c inch	d inch	e inch	f inch	g inch	lbs
0.25	8	5/16	5 1/32	4 5/16	2 23/32	23/32	5/8	11/32	1 7/16	1.76
0.5	12	3/8	6 1/2	5 19/32	3 9/32	13/16	25/32	7/16	1 13/16	3.31
1	20	1/2	6 7/8	5 3/4	3 31/32	1	1	15/32	2 1/4	5.29
2	25	5/8	8 5/16	6 29/32	4 7/8	1 1/4	1 3/16	19/32	2 3/4	10.58
3	40	3/4	9 15/16	8 11/32	5 7/16	1 17/32	1 3/8	5/8	3 5/32	18.3
4	55	7/8	11 11/32	9 1/2	5 13/16	1 3/4	1 5/8	3/4	3 3/4	24.3
5	75	1	12 15/16	10 25/32	6 29/32	2	1 31/32	7/8	4 5/16	39.5
6	90	1 1/8	14 3/4	12 3/16	7 19/32	2 1/4	2 1/4	1	5 1/8	46.3
7	110	1 1/4	16 11/16	13 25/32	8 9/32	2 1/2	2 1/2	1 1/8	5 3/4	72.8
8	125	1 3/8	18 11/16	15 3/4	8 17/32	2 23/32	2 9/16	1 1/8	5 13/16	92.6
9	150	1 1/2	20 3/4	17 3/4	9 3/32	3	2 3/4	1 3/16	6	114.6
10	170	1 5/8	22 13/16	19 23/32	9 5/8	3	3 1/32	1 5/16	6 9/32	160.9

CAD



Green Pin® Short Bow Socket

Closed spelter socket

- **Material:** cast alloy steel
- **Finish:** hot dipped galvanized
- **Certification:** 2.1 2.2 3.1 CE



G-6416

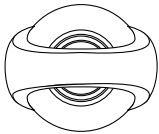
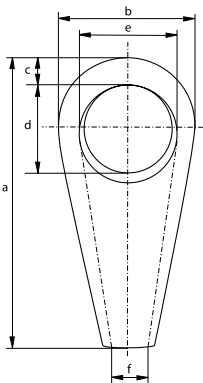

minimum breaking load	rope size	length	width	thicknes bow	length eye	width eye	opening	weight each
t	mm	a mm	b mm	c mm	d mm	e mm	f mm	kg
140	31-36	262	132	38	83	75	39	7
160	37-42	305	152	40	103	92	44	10
200	43-48	356	178	48	120	112	51	16
250	49-54	390	200	54	132	120	59	21
320	55-60	440	220	62	148	135	64	28
400	61-68	498	250	68	165	150	73	44
500	69-75	540	274	75	178	164	79	53
600	76-80	585	295	76	195	175	89	70
700	81-86	625	320	82	216	194	92	81
800	87-93	670	350	92	220	202	99	112
900	94-102	700	375	100	235	215	108	130
1000	108-115	800	410	110	270	240	120	182

In inch

minimum breaking load	rope size	length	width	thicknes bow	length eye	width eye	opening	weight each
t	inch	a inch	b inch	c inch	d inch	e inch	f inch	lbs
140	1 1/4 - 1 3/8	10 5/16	5 3/16	1 1/2	3 9/32	2 15/16	1 17/32	15.4
160	1 1/2 - 1 5/8	12	5 31/32	1 9/16	4 1/16	3 5/8	1 23/32	22.1
200	1 3/4 - 1 7/8	14 1/32	7	1 7/8	4 23/32	4 13/32	2	35.3
250	2 - 2 1/8	15 11/32	7 7/8	2 1/8	5 3/16	4 23/32	2 5/16	46.3
320	2 1/4 - 2 3/8	17 5/16	8 21/32	2 7/16	5 13/16	5 5/16	2 17/32	61.7
400	2 1/2 - 2 5/8	19 19/32	9 27/32	2 11/16	6 1/2	5 29/32	2 7/8	97
500	2 3/4 - 2 7/8	21 1/4	10 25/32	2 15/16	7	6 15/32	3 1/8	116.9
600	3 - 3 1/8	23 1/32	11 5/8	3	7 11/16	6 7/8	3 1/2	154.3
700	3 1/4 - 3 3/8	24 19/32	12 19/32	3 7/32	8 1/2	7 5/8	3 5/8	178.6
800	3 1/2 - 3 5/8	26 3/8	13 25/32	3 5/8	8 21/32	7 15/16	3 29/32	246.9
900	3 3/4 - 4	27 9/16	14 3/4	3 15/16	9 1/4	8 15/32	4 1/4	286.6
1000	4 1/4 - 4 1/2	31 1/2	16 5/32	4 11/32	10 5/8	9 7/16	4 23/32	401.3

Green Pin® Open Swage Socket CP

Open type swage socket with cotter pin

- **Material:** drop forged steel C-1035
- **Finish:** self coloured
- **Certification:** 2.1



S-6414

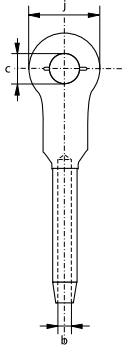
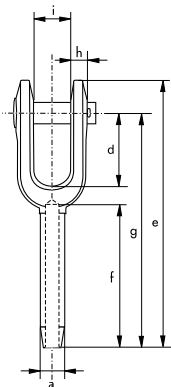

diameter rope	diameter before swage	diameter after swage		diameter inside	diameter pin	length	length	length	length	thickness	width inside	width eye	weight each
		min	max										
mm	a	a	a	b	c	d	e	f	g	h	i	j	kg
6	13	10.9	11.7	7	17	38	121	54	102	8	17	35	0.25
8	20	17.2	18.0	9	21	44	159	81	135	10	21	41	0.57
10	20	17.2	18.0	10	21	44	159	81	135	10	21	41	0.56
11	25	22.0	23.1	12	25	51	198	108	169	13	25	51	1.11
13	25	22.0	23.1	14	25	51	198	108	169	13	25	51	1.08
14	32	28.3	29.5	15	30	57	243	135	206	16	32	63	2.11
16	32	28.3	29.5	17	30	57	243	135	206	16	32	63	2.06
19	39	34.7	36.1	20	35	70	297	162	254	19	38	76	3.68
22	43	37.8	39.4	24	41	83	346	189	295	23	44	86	5.38
25	50	44.2	45.7	27	51	95	397	216	340	26	51	102	5.45
28	57	50.5	52.1	30	57	108	444	243	381	30	57	114	12
32	64	56.9	58.4	34	64	121	494	270	419	30	63	127	16.2
35	71	63.2	65.0	37	64	133	540	297	460	33	63	133	20.5
38	78	69.6	71.4	40	70	146	591	324	502	37	76	146	29.5
44	86	75.9	77.7	47	89	171	689	378	584	43	89	178	42.2
51	100	88.6	90.4	54	95	203	798	432	679	46	102	203	65.8
57	113	100.3	102.1	60	108	171	835	486	705	65	114	222	93.4
63	125	110.5	112.3	67	108	171	879	498	749	65	114	222	103
76	151	133.1	134.9	80	133	219	1045	603	905	76	146	241	181

In inch

diameter rope	diameter before swage	diameter after swage		diameter inside	diameter pin	length	length	length	length	thickness	width inside	width eye	weight each
		min	max										
inch	a	a	a	b	c	d	e	f	g	h	i	j	lbs
1/4	0.495	0.428	0.460	0.272	11/16	1 1/2	4 3/4	2 1/8	4	5/16	11/16	1 3/8	0.57
5/16	0.770	0.678	0.710	0.339	13/16	1 3/4	6 1/4	3 3/16	5 5/16	13/32	13/16	1 5/8	1.25
3/8	0.770	0.678	0.710	0.406	13/16	1 3/4	6 1/4	3 3/16	5 5/16	13/32	13/16	1 5/8	1.20
7/16	0.982	0.865	0.910	0.484	1	2	7 13/16	4 1/4	6 11/16	1/2	1	2	2.45
1/2	0.982	0.865	0.910	0.547	1	2	7 13/16	4 1/4	6 11/16	1/2	1	2	2.40
9/16	1.257	1.115	1.160	0.609	1 3/16	2 1/4	9 9/16	5 5/16	8 1/8	5/8	1 1/4	2 1/2	4.80
5/8	1.257	1.115	1.160	0.672	1 3/16	2 1/4	9 9/16	5 5/16	8 1/8	5/8	1 1/4	2 1/2	4.50
3/4	1.545	1.365	1.420	0.796	1 3/8	2 3/4	11 11/16	6 3/8	10	3/4	1 1/2	3	7.80
7/8	1.700	1.490	1.550	0.938	1 5/8	3 1/4	13 5/8	7 7/16	11 5/8	15/16	1 3/4	3 3/8	11.8
1	1.975	1.740	1.800	1.062	2	3 3/4	15 5/8	8 1/2	13 3/8	1 1/32	2	4	17.8
1 1/8	2.245	1.990	2.050	1.188	2 1/4	4 1/4	17 1/2	9 9/16	15	1 3/16	2 1/4	4 1/2	28.9
1 1/4	2.525	2.240	2.300	1.328	2 1/2	4 3/4	19 7/16	10 5/8	16 1/2	1 3/16	2 1/2	5	36.2
1 3/8	2.800	2.490	2.560	1.453	2 1/2	5 1/4	21 1/4	11 11/16	18 1/8	1 5/16	2 1/2	5 1/4	47.7
1 1/2	3.075	2.740	2.810	1.578	2 3/4	5 3/4	23 1/4	12 3/4	19 3/4	1 7/16	3	5 3/4	64.4
1 3/4	3.385	2.990	3.060	1.859	3 1/2	6 3/4	27 1/8	14 7/8	23	1 11/16	3 1/2	7	93.4
2	3.935	3.490	3.560	2.109	3 3/4	8	31 7/16	17	26 3/4	1 13/16	4	8	148
2 1/4	4.450	3.950	4.020	2.360	4 1/4	6 3/4	32 7/8	19 1/8	27 3/4	2 9/16	4 1/2	8 3/4	173
2 1/2	4.930	4.350	4.420	2.657	4 1/4	6 3/4	34 5/8	19 5/8	29 1/2	2 9/16	4 1/2	8 3/4	233
3	5.960	5.240	5.310	3.166	5 1/4	8 5/8	41 1/8	23 3/4	35 5/8	3	5 3/4	9 1/2	382

CAD



Green Pin® Closed Swage Socket

Closed type

- **Material:** drop forged steel C-1035
- **Finish:** self coloured
- **Certification:** 2.1



S-6415

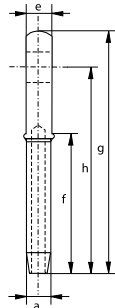
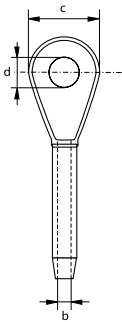

diameter rope	diameter before swage	diameter after swage		diameter inside	diameter	diameter eye	thickness	length	length	length	weight each
		min	max								
mm	a	a	a	b	c	d	e	f	g	h	kg
6	13	10.9	11.7	7	37	19	13	54	111	89	0.15
8	20	17.2	18.0	9	43	22	17	81	140	114	0.35
10	20	17.2	18.0	10	43	22	17	81	140	114	0.33
11	25	22.0	23.1	12	51	27	22	108	176	146	0.66
13	25	22.0	23.1	14	51	27	22	108	176	146	0.62
14	32	28.3	29.5	15	63	32	29	135	222	184	1.35
16	32	28.3	29.5	17	63	32	29	135	222	184	1.31
19	39	34.7	36.1	20	76	37	33	162	264	219	2.3
22	43	37.8	39.4	24	89	43	38	189	308	257	3.40
25	50	44.2	45.7	27	102	52	44	216	349	292	4.97
28	57	50.5	52.1	30	114	59	51	243	387	324	7.17
32	64	56.9	58.4	34	127	65	57	270	438	365	10.4
35	71	63.2	65.0	37	133	65	57	297	479	400	13.3
38	78	69.6	71.4	40	140	71	63	324	518	432	17.7
44	86	75.9	77.7	47	171	91	76	378	610	508	23.6
51	100	88.6	90.4	54	197	97	83	432	698	584	40.8
57	113	100.3	102.1	60	219	110	102	486	756	632	55.3
63	125	110.5	112.3	67	219	110	102	498	791	667	64.4
76	151	133.1	134.9	80	235	135	137	603	959	816	114

In inch

diameter rope	diameter before swage	diameter after swage		diameter inside	diameter	diameter eye	thickness	length	length	length	weight each
		min	max								
inch	a	a	a	b	c	d	e	f	g	h	lbs
1/4	0.495	0.428	0.460	0.272	1 7/16	3/4	1/2	2 1/8	4 3/8	3 1/2	0.35
5/16	0.770	0.678	0.710	0.339	1 11/16	7/8	11/16	3 3/16	5 1/2	4 1/2	0.77
3/8	0.770	0.678	0.710	0.406	1 11/16	7/8	11/16	3 3/16	5 1/2	4 1/2	0.73
7/16	0.982	0.865	0.910	0.484	2	1 1/16	7/8	4 1/4	6 15/16	5 3/4	1.47
1/2	0.982	0.865	0.910	0.547	2	1 1/16	7/8	4 1/4	6 15/16	5 3/4	1.38
9/16	1.257	1.115	1.160	0.609	2 1/2	1 1/4	1 1/8	5 5/16	8 3/4	7 1/4	2.90
5/8	1.257	1.115	1.160	0.672	2 1/2	1 1/4	1 1/8	5 5/16	8 3/4	7 1/4	2.80
3/4	1.545	1.365	1.420	0.796	3	1 7/16	1 5/16	6 3/8	10 3/8	8 5/8	5.16
7/8	1.700	1.490	1.550	0.938	3 1/2	1 11/16	1 1/2	7 7/16	12 1/8	10 1/8	7.40
1	1.975	1.740	1.800	1.062	4	2 1/16	1 3/4	8 1/2	13 3/4	11 1/2	11.2
1 1/8	2.245	1.990	2.050	1.188	4 1/2	2 5/16	2	9 9/16	15 1/4	12 3/4	16
1 1/4	2.525	2.240	2.300	1.328	5	2 9/16	2 1/4	10 5/8	17 1/4	14 3/8	22.7
1 3/8	2.800	2.490	2.560	1.453	5 1/4	2 9/16	2 1/4	11 11/16	18 7/8	15 3/4	29
1 1/2	3.075	2.740	2.810	1.578	5 1/2	2 13/16	2 1/2	12 3/4	20 3/8	17	37.5
1 3/4	3.385	2.990	3.060	1.859	6 3/4	3 9/16	3	14 7/8	24	20	55.7
2	3.935	3.490	3.560	2.109	7 3/4	3 13/16	3 1/4	17	27 1/2	23	90
2 1/4	4.450	3.950	4.020	2.360	8 5/8	4 5/16	4	19 1/8	29 3/4	24 7/8	125
2 1/2	4.930	4.350	4.420	2.657	8 5/8	4 5/16	4	19 5/8	31 1/8	26 1/4	142
3	5.960	5.240	5.310	3.166	9 1/4	5 5/16	5 5/8	23 3/4	37 3/4	32 1/8	252

CAD



TURNBUCKLES



Applications

Turnbuckles are used for rigging or tensioning wires, ropes, rods etc. They are designed for in-line rigging, tensioning or lashing. Green Pin® Turnbuckles (G-6313, G-6323, G-6333, G-6311, G-6312, G-6315 and G-6314) can be used in lifting applications. The closed body rigging screws (G-6343, G-6340 and G-6345) can also be used in lifting applications.

Range

Green Pin® offers a wide range of turnbuckles:

- Load rated Green Pin® turnbuckles;
- Open body rigging screws generally to DIN 1480;
- Rigging screws with welding ends;
- Closed body rigging screws;
- Special turnbuckles for lashing (hamburgers).

Van Beest offers a wide range of other turnbuckles to complement the Green Pin® assortment.

Design

Green Pin® turnbuckles are manufactured to ASTM F1145-92 (formerly U.S. Fed. Spec. FF-T-791). They are drop-forged and available with the following end fittings: eye/eye, hook/hook, hook/eye, jaw/jaw and jaw/eye. All fittings are interchangeable. Locking nuts are supplied with all sizes.

All Green Pin® turnbuckles are generally marked with:

- Working Load Limit - e.g. 2.36 t
- manufacturer's symbol - e.g. GP
- thread diameter - e.g. 3/4"
- traceability code - e.g. A1
- thread - L (lefthanded) and R (righthanded)

Rigging screws generally to DIN 1480 are available with welding ends and in hook/eye, eye/eye, hook/hook and jaw/jaw combinations. Closed body rigging screws are available in jaw/jaw, jaw/eye and eye/eye combinations.

Finish

Load rated Green Pin® turnbuckles and closed body rigging screws are hot dipped galvanized. Rigging screws to DIN 1480 are electro-galvanized. Lashing turnbuckles are self coloured.

Certification

Specific details of certificate availability can be found on each product page. Please verify your certification requirements at the time of order.

Instructions for use

Turnbuckles must be used for in-line applications only. Special attention should be paid to prevent overloading. During tensioning, avoid forces on the turnbuckle that may lead to deformation. Should a turnbuckle start to deform, the tension should be decreased immediately and any deformed parts should be replaced. Should extreme circumstances or shock loading, possibly occur during use, this must be taken into account when selecting the correct products to be used for the application.

For the rigging of wires, ropes, rods etc., Green Pin® turnbuckles are recommended to be used. The WLL should be applied in in-line lifting only and overloading is not permitted. Nor should side loads be applied, as the products have not been designed for this purpose.

Open body rigging screws are used for tensioning wires and ropes for less demanding applications (for example rope railings).

Turnbuckles must be regularly inspected in accordance with the safety standards given in the country of use. This is required because the products in use may be affected by wear, misuse, overloading etc. which may lead to deformation and alteration of the steel structure.

Safe use of turnbuckles

Turnbuckles should be inspected before use to ensure that:

- all markings are legible;
- the threads of the body and the end fittings are of the same type;
- the pin, nut, cotter pin, or any other locking system cannot vibrate out of position;
- the threads of the body and the end fittings are undamaged;
- the body and end fittings are not distorted or unduly worn;
- the body and end fittings are free from nicks, gouges and cracks.

Make sure that the end fittings are correctly screwed into the body. Always use the locking nuts provided to prevent the turnbuckles from unscrewing. Never replace an end fitting by anything other than one designed for the purpose, otherwise the turnbuckle may not be suitable for the loads imposed.



Green Pin® JJ Turnbuckle CP

Turnbuckle with jaw-jaw end-fitting and cotter pins, generally to ASTM F1145-92



G-6313

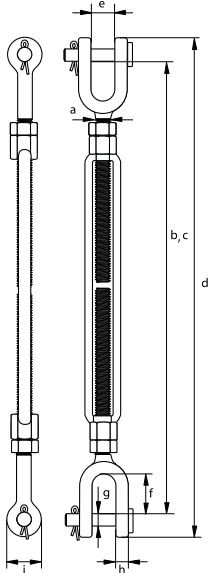

- **Material:** drop forged high tensile steel SAE 1035 or 1045
- **Safety factor:** MBL equals 5 x WLL
- **Standard:** generally to ASTM F1145-92
formerly U.S. Federal Specification FF-T-791b
hot dipped galvanized
- **Finish:**
- **Certification:** 2.1 2.2 3.1 MTC[®] CE

working load limit	diameter thread	take up	length closed position	length open position	length closed position	opening jaw	length inside	diameter pin	thickness jaw eye	diameter jaw eye	weight each
t	a inch	inch	b mm	c mm	d mm	e mm	f mm	g mm	h mm	i mm	kg
2.36	3/4	6	369	487	439	24	38	16	16	41	2.59
2.36	3/4	9	444	640	514	24	38	16	16	41	3.13
2.36	3/4	12	520	792	590	24	38	16	16	41	3.42
2.36	3/4	18	670	1096	740	24	38	16	16	41	4.51
3.27	7/8	12	561	826	638	27	42	19	19	48	4.93
3.27	7/8	18	713	1132	790	27	42	19	19	48	6.41
4.54	1	6	447	554	532	31	50	22	20	54	5.18
4.54	1	12	598	859	683	31	50	22	20	54	6.43
4.54	1	18	750	1168	835	31	50	22	20	54	8.4
4.5	1	24	903	1470	988	31	50	22	20	54	8.9
6.9	1 1/4	12	641	914	748	44	71	29	26	68	11.2
6.9	1 1/4	18	803	1228	910	44	71	29	26	68	13.6
6.9	1 1/4	24	962	1539	1069	44	71	29	26	68	15
9.71	1 1/2	12	675	942	806	52	71	35	28	80	17
9.71	1 1/2	18	825	1244	956	52	71	35	28	80	19.3
9.71	1 1/2	24	980	1551	1111	52	71	35	28	80	20.7
12.7	1 3/4	18	938	1316	1092	60	86	41	33	90	25
12.7	1 3/4	24	1089	1621	1243	60	86	41	33	90	28.7
16.8	2	24	1151	1671	1338	63	93	51	40	107	45.4
27.2	2 1/2	24	1255	1831	1480	75	114	57	41	143	88
34	2 3/4	24	1348	1882	1604	90	110	70	41	158	98

In inch

working load limit	diameter thread	take up	length closed position	length open position	length closed position	opening jaw	length inside	diameter pin	thickness jaw eye	diameter jaw eye	weight each
t	a inch	inch	b inch	c inch	d inch	e inch	f inch	g inch	h inch	i inch	lbs
2.36	3/4	6	14 17/32	19 3/16	17 5/16	15/16	1 17/32	5/8	5/8	1 5/8	5.71
2.36	3/4	9	17 17/32	25 3/16	20 1/4	15/16	1 17/32	5/8	5/8	1 5/8	6.90
2.36	3/4	12	20 1/2	31 5/32	23 1/4	15/16	1 17/32	5/8	5/8	1 5/8	7.54
2.36	3/4	18	26 11/32	43 5/32	29 1/8	15/16	1 17/32	5/8	5/8	1 5/8	9.94
3.27	7/8	12	22 3/32	32 17/32	25 1/8	1 3/32	1 11/16	3/4	3/4	1 29/32	10.87
3.27	7/8	18	28 1/32	44 9/16	31 3/32	1 3/32	1 11/16	3/4	3/4	1 29/32	14.13
4.54	1	6	17 5/8	21 13/16	20 15/16	1 1/4	1 31/32	7/8	25/32	2 1/8	11.42
4.54	1	12	23 9/16	33 13/16	26 7/8	1 1/4	1 31/32	7/8	25/32	2 1/8	14.18
4.54	1	18	29 17/32	46	32 7/8	1 1/4	1 31/32	7/8	25/32	2 1/8	18.52
4.5	1	24	35 9/16	57 7/8	38 29/32	1 1/4	1 31/32	7/8	25/32	2 1/8	19.62
6.9	1 1/4	12	25 1/4	35 31/32	29 7/16	1 3/4	2 25/32	1 5/32	1 1/32	2 11/16	24.7
6.9	1 1/4	18	31 5/8	48 11/32	35 13/16	1 3/4	2 25/32	1 5/32	1 1/32	2 11/16	30.0
6.9	1 1/4	24	37 7/8	60 19/32	42 3/32	1 3/4	2 25/32	1 5/32	1 1/32	2 11/16	33.1
9.71	1 1/2	12	26 9/16	37 3/32	31 3/4	2 1/32	2 25/32	1 3/8	1 1/8	3 5/32	37.5
9.71	1 1/2	18	32 1/2	48 31/32	37 5/8	2 1/32	2 25/32	1 3/8	1 1/8	3 5/32	42.5
9.71	1 1/2	24	38 19/32	61 1/16	43 3/4	2 1/32	2 25/32	1 3/8	1 1/8	3 5/32	45.6
12.7	1 3/4	18	36 29/32	51 13/16	43	2 11/32	3 3/8	1 5/8	1 5/16	3 9/16	55.1
12.7	1 3/4	24	42 7/8	63 15/16	48 15/16	2 11/32	3 3/8	1 5/8	1 5/16	3 9/16	63.3
16.8	2	24	45 5/16	65 25/32	52 11/16	2 1/2	3 11/16	2	1 19/32	4 3/16	100.1
27.2	2 1/2	24	49 13/32	72 3/32	58 9/32	2 15/16	4 1/2	2 1/4	1 5/8	5 5/8	194.0
34	2 3/4	24	53 3/32	74 3/32	63 5/32	3 9/16	4 5/16	2 3/4	1 5/8	6 3/16	216.1

INFO CAD



Green Pin® JJ Turnbuckle BN

Turnbuckle with jaw-jaw end-fitting and safety bolt, generally to ASTM F1145-92

- **Material:** drop forged high tensile steel SAE 1035 or 1045
- **Safety factor:** MBL equals 5 x WLL
- **Standard:** generally to ASTM F1145-92
formerly U.S. Federal Specification FF-T-791b
- **Finish:** hot dipped galvanized
- **Certification:** 2.1 2.2 3.1 MTC^a CE



G-6323

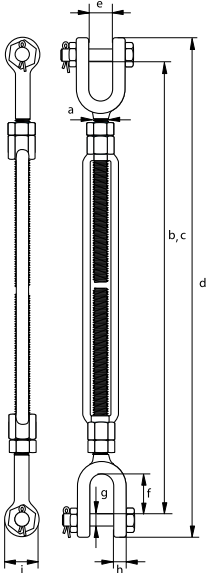

working load limit	diameter thread	take up	length closed position	length open position	length closed position	opening jaw	length inside	diameter pin	thickness jaw eye	diameter jaw eye	weight each
t	a inch	inch	b mm	c mm	d mm	e mm	f mm	g mm	h mm	i mm	kg
0.54	3/8	6	273	409	304	12	21	7	9	21	0.55
1	1/2	6	304	435	343	16	26	10	11	25	0.96
1	1/2	9	379	588	418	16	26	10	11	25	1.18
1	1/2	12	455	740	494	16	26	10	11	25	1.50
1.59	5/8	6	346	469	406	18	32	13	14	33	1.75
1.59	5/8	9	421	622	480	18	32	13	14	33	2.14
1.59	5/8	12	498	774	557	18	32	13	14	33	2.43
2.36	3/4	6	369	487	439	24	38	16	16	41	2.7
2.36	3/4	9	444	640	514	24	38	16	16	41	3.23
2.36	3/4	12	520	792	590	24	38	16	16	41	3.57
2.36	3/4	18	670	1096	740	24	38	16	16	41	4.55
3.27	7/8	12	561	826	638	27	42	19	19	48	5.22
3.27	7/8	18	713	1132	790	27	42	19	19	48	6.56
4.54	1	6	447	554	532	31	50	22	20	54	5.54
4.54	1	12	598	859	683	31	50	22	20	54	6.96
4.54	1	18	750	1168	835	31	50	22	20	54	8.4
4.5	1	24	903	1470	988	31	50	22	20	54	8.9
6.9	1 1/4	12	643	916	748	44	71	28	26	68	11.9
6.9	1 1/4	18	805	1230	910	44	71	28	26	68	13.6
6.9	1 1/4	24	964	1541	1069	44	71	28	26	68	14.2
9.71	1 1/2	12	675	942	806	52	71	35	28	80	18.5
9.71	1 1/2	18	825	1244	956	52	71	35	28	80	19.3
9.71	1 1/2	24	980	1551	1111	52	71	35	28	80	22
12.7	1 3/4	18	938	1316	1092	60	86	41	33	90	30
12.7	1 3/4	24	1089	1621	1243	60	86	41	33	90	33
16.8	2	24	1153	1673	1338	63	93	50	40	107	50
27.2	2 1/2	24	1255	1831	1480	75	114	57	41	143	92
34	2 3/4	24	1348	1882	1604	90	110	70	41	158	109

INFO CAD

continued on next page >



Green Pin® JJ Turnbuckle BN (continued)

Turnbuckle with jaw-jaw end-fitting and safety bolt, generally to ASTM F1145-92



G-6323

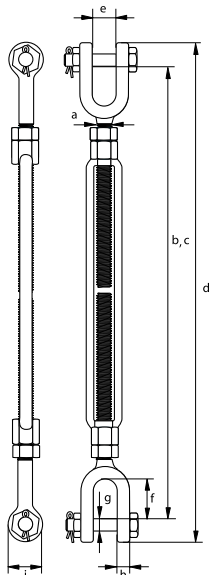

- **Material:** drop forged high tensile steel SAE 1035 or 1045
- **Safety factor:** MBL equals 5 x WLL
- **Standard:** generally to ASTM F1145-92
formerly U.S. Federal Specification FF-T-791b
hot dipped galvanized
- **Finish:**
- **Certification:** 2.1 2.2 3.1 MTC[®] CE

In inch

working load limit	diameter thread	take up	length closed position	length open position	length closed position	opening jaw	length inside	diameter pin	thickness jaw eye	diameter jaw eye	weight each
t	a inch	inch	b inch	c inch	d inch	e inch	f inch	g inch	h inch	i inch	lbs
0.54	3/8	6	10 3/4	16 1/8	11 31/32	15/32	13/16	9/32	11/32	13/16	1.21
1	1/2	6	11 31/32	17 5/32	13 17/32	5/8	1 1/32	13/32	7/16	1	2.12
1	1/2	9	14 29/32	23 5/32	16 1/2	5/8	1 1/32	13/32	7/16	1	2.60
1	1/2	12	17 15/16	29 1/8	19 1/2	5/8	1 1/32	13/32	7/16	1	3.31
1.59	5/8	6	13 5/8	18 1/2	16	23/32	1 9/32	1/2	9/16	1 5/16	3.86
1.59	5/8	9	16 19/32	24 1/2	18 29/32	23/32	1 9/32	1/2	9/16	1 5/16	4.72
1.59	5/8	12	19 9/8	30 7/16	21 15/16	23/32	1 9/32	1/2	9/16	1 5/16	5.36
2.36	3/4	6	14 17/32	19 3/16	17 5/16	15/16	1 17/32	5/8	5/8	1 5/8	5.95
2.36	3/4	9	17 17/32	25 3/16	20 1/4	15/16	1 17/32	5/8	5/8	1 5/8	7.12
2.36	3/4	12	20 1/2	31 5/32	23 1/4	15/16	1 17/32	5/8	5/8	1 5/8	7.87
2.36	3/4	18	26 11/32	43 5/32	29 1/8	15/16	1 17/32	5/8	5/8	1 5/8	10.03
3.27	7/8	12	22 3/32	32 17/32	25 1/8	1 3/32	1 11/16	3/4	3/4	1 29/32	11.51
3.27	7/8	18	28 4/32	44 9/16	31 3/32	1 3/32	1 11/16	3/4	3/4	1 29/32	14.46
4.54	1	6	17 5/8	21 13/16	20 15/16	1 1/4	1 31/32	7/8	25/32	2 1/8	12.21
4.54	1	12	23 9/16	33 13/16	26 7/8	1 1/4	1 31/32	7/8	25/32	2 1/8	15.34
4.54	1	18	29 17/32	46	32 7/8	1 1/4	1 31/32	7/8	25/32	2 1/8	18.52
4.5	1	24	35 9/16	57 7/8	38 29/32	1 1/4	1 31/32	7/8	25/32	2 1/8	19.62
6.9	1 1/4	12	25 5/16	36 1/32	29 7/16	1 3/4	2 25/32	1 1/8	1 1/32	2 11/16	26.2
6.9	1 1/4	18	31 23/32	48 7/8	35 13/16	1 3/4	2 25/32	1 1/8	1 1/32	2 11/16	30
6.9	1 1/4	24	37 15/16	60 11/16	42 3/32	1 3/4	2 25/32	1 1/8	1 1/32	2 11/16	31.3
9.71	1 1/2	12	26 9/16	37 3/32	31 3/4	2 1/32	2 25/32	1 3/8	1 1/8	3 5/32	40.8
9.71	1 1/2	18	32 1/2	48 31/32	37 5/8	2 1/32	2 25/32	1 3/8	1 1/8	3 5/32	42.5
9.71	1 1/2	24	38 19/32	61 1/16	43 3/4	2 1/32	2 25/32	1 3/8	1 1/8	3 5/32	48.5
12.7	1 3/4	18	36 29/32	51 13/16	43	2 11/32	3 3/8	1 5/8	1 5/16	3 9/16	66.1
12.7	1 3/4	24	42 7/8	63 13/16	48 15/16	2 11/32	3 3/8	1 5/8	1 5/16	3 9/16	72.8
16.8	2	24	45 13/32	65 7/8	52 11/16	2 1/2	3 11/16	1 31/32	1 19/32	4 3/16	110
27.2	2 1/2	24	49 13/32	72 3/32	58 9/32	2 15/16	4 1/2	2 1/4	1 5/8	5 5/8	203
34	2 3/4	24	53 3/32	74 3/32	63 5/32	3 9/16	4 5/16	2 3/4	1 5/8	6 3/16	240

INFO CAD



Green Pin Polar® JJ Turnbuckle BN

Grade 8 turnbuckle with jaw-jaw end-fitting and safety bolt for use under low temperatures, generally to ASTM F1145-92



G-6333

- **Material:** drop forged alloy steel, grade 8, quenched and tempered
- **Safety factor:** MBL equals 5 x WLL
- **Standard:** generally to ASTM F1145-92
formerly U.S. Federal Specification FF-T-791b
- **Finish:** hot dipped galvanized
- **Temperature Range:** -40°C up to +200°C
- **Certification:** 2.1 2.2 3.1 MTC³ CE
- **Note:** jaw ends up to and including 5/8" are fitted with bolts and nuts, sizes 3/4" and up are equipped with bolts, nuts and cotter pins

working load limit	diameter thread	take up	length closed position	length open position	length closed position	opening jaw	length inside	diameter pin	thickness jaw eye	diameter jaw eye	weight each
t	a inch	inch	b mm	c mm	d mm	e mm	f mm	g mm	h mm	i mm	kg
1	1/2	12	455	740	494	16	26	10	11	25	1.50
1.59	5/8	12	498	774	557	18	32	13	14	33	2.32
2.36	3/4	18	670	1096	740	24	38	16	16	41	4.57
3.27	7/8	18	713	1132	790	27	42	19	19	48	6.5
4.54	1	18	750	1168	835	31	50	22	20	54	8.4
6.9	1 1/4	18	805	1230	910	44	71	28	26	68	13.6
9.71	1 1/2	18	825	1244	956	52	71	35	28	80	21.1
12.7	1 3/4	18	938	1316	1092	60	86	41	33	90	30

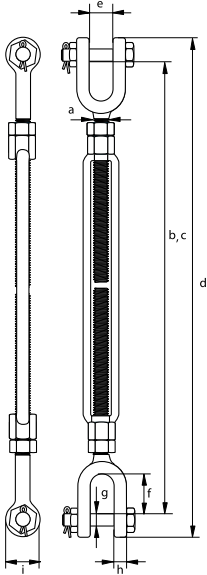

In inch

working load limit	diameter thread	take up	length closed position	length open position	length closed position	opening jaw	length inside	diameter pin	thickness jaw eye	diameter jaw eye	weight each
t	a inch	inch	b inch	c inch	d inch	e inch	f inch	g inch	h inch	i inch	lbs
1	1/2	12	17 15/16	29 1/8	19 1/2	5/8	1 1/32	13/32	7/16	1	3.31
1.59	5/8	12	19 5/8	30 7/16	21 15/16	23/32	1 9/32	1/2	9/16	1 5/16	5.11
2.36	3/4	18	26 11/32	43 5/32	29 1/8	15/16	1 17/32	5/8	5/8	1 5/8	10.08
3.27	7/8	18	28 1/32	44 9/16	31 3/32	1 3/32	1 11/16	3/4	3/4	1 29/32	14.33
4.54	1	18	29 17/32	46	32 7/8	1 1/4	1 31/32	7/8	25/32	2 1/8	18.52
6.9	1 1/4	18	31 23/32	48 7/8	35 13/16	1 3/4	2 25/32	1 1/8	1 1/32	2 11/16	30
9.71	1 1/2	18	32 1/2	48 31/32	37 5/8	2 1/32	2 25/32	1 3/8	1 1/8	3 5/32	46.5
12.7	1 3/4	18	36 29/32	51 13/16	43	2 11/32	3 3/8	1 5/8	1 5/16	3 9/16	66.1

INFO CAD



Green Pin® EE Turnbuckle

Turnbuckle with eye-eye end-fitting, generally to ASTM F1145-92

- **Material:** drop forged high tensile steel SAE 1035 or 1045
- **Safety factor:** MBL equals 5 x WLL
- **Standard:** generally to ASTM F1145-92
formerly U.S. Federal Specification FF-T-791b
- **Finish:** hot dipped galvanized
- **Certification:** 2.1 2.2 3.1 MTC^a CE



G-6311

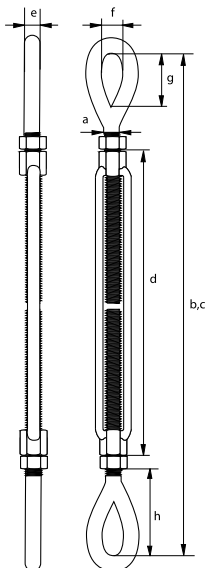

working load limit	diameter thread	take up	length closed position	length open position	length	diameter	width inside	length inside	length closed position	weight each
t	a inch	inch	b mm	c mm	d mm	e mm	f mm	g mm	h mm	kg
0.54	3/8	6	292	428	183	10	13	29	49	0.48
1	1/2	6	325	455	193	12	18	36	58	0.81
1	1/2	9	400	608	270	12	18	36	57	1.07
1	1/2	12	476	760	346	12	18	36	57	1.29
1.59	5/8	6	380	503	203	14	21	45	79	1.33
1.59	5/8	9	455	656	280	14	21	45	78	1.61
1.59	5/8	12	531	808	356	14	21	45	78	1.96
2.36	3/4	6	413	532	214	17	26	54	89	2.03
2.36	3/4	9	490	685	291	17	26	54	89	2.47
2.36	3/4	12	564	837	367	17	26	54	88	2.9
2.36	3/4	18	718	1143	519	17	26	54	89	3.94
3.27	7/8	12	604	870	377	20	32	61	101	4.31
3.27	7/8	18	756	1174	529	20	32	61	101	5.51
4.54	1	6	498	604	234	24	37	76	118	4.35
4.54	1	12	649	909	387	24	37	76	117	5.75
4.54	1	18	801	1215	539	24	37	76	117	7.27
4.5	1	24	952	1518	692	24	37	76	116	7.52
6.9	1 1/4	12	712	985	385	29	47	91	145	9.28
6.9	1 1/4	18	862	1287	537	29	47	91	144	11.1
6.9	1 1/4	24	1015	1592	690	29	47	91	144	12.1
9.71	1 1/2	12	756	1023	401	32	55	106	156	14.2
9.71	1 1/2	18	916	1335	553	32	55	106	160	15.8
9.71	1 1/2	24	1065	1636	706	32	55	106	158	17.1
12.7	1 3/4	18	1020	1396	577	38	61	120	197	23.1
12.7	1 3/4	24	1171	1703	730	38	61	120	196	26.3
16.8	2	24	1264	1784	748	46	69	147	230	40.7
27.2	2 1/2	24	1430	1934	802	51	80	165	274	64
34	2 3/4	24	1450	1988	802	57	84	178	284	88

INFO CAD

continued on next page >



Green Pin® EE Turnbuckle (continued)

Turnbuckle with eye-eye end-fitting, generally to ASTM F1145-92

- **Material:** drop forged high tensile steel SAE 1035 or 1045
- **Safety factor:** MBL equals 5 x WLL
- **Standard:** generally to ASTM F1145-92
formerly U.S. Federal Specification FF-T-791b
- **Finish:** hot dipped galvanized
- **Certification:** 2.1 2.2 3.1 MTC[®] CE



G-6311

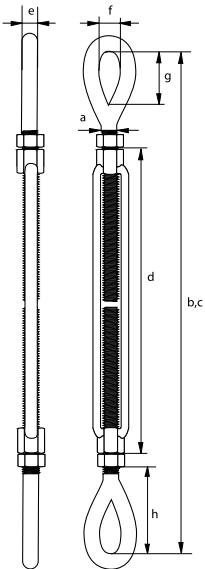

In inch

working load limit	diameter thread	take up	length closed position	length open position	length	diameter	width inside	length inside	length closed position	weight each
t	a	inch	b	c	d	e	f	g	h	lbs
0.54	3/8	6	11 17/32	16 7/8	7 3/16	13/32	1/2	1 5/32	1 15/16	1.06
1	1/2	6	12 25/32	17 15/16	7 19/32	15/32	23/32	1 7/16	2 9/32	1.79
1	1/2	9	15 5/4	23 15/16	10 5/8	15/32	23/32	1 7/16	2 1/4	2.36
1	1/2	12	18 3/4	29 29/32	13 5/8	15/32	23/32	1 7/16	2 3/4	2.84
1.59	5/8	6	14 15/16	19 13/16	8	9/16	13/16	1 25/32	3 1/8	2.93
1.59	5/8	9	17 15/16	25 13/16	11 11/32	9/16	13/16	1 25/32	3 3/32	3.55
1.59	5/8	12	20 29/32	31 13/16	14	9/16	13/16	1 25/32	3 3/32	4.32
2.36	3/4	6	16 9/32	20 15/16	8 7/16	11/16	1 1/32	2 1/8	3 17/32	4.48
2.36	3/4	9	19 5/16	26 15/16	11 1/2	11/16	1 1/32	2 1/8	3 17/32	5.45
2.36	3/4	12	22 3/16	32 15/16	14 7/16	11/16	1 1/32	2 1/8	3 1/2	6.39
2.36	3/4	18	28 1/4	45	20 7/16	11/16	1 1/32	2 1/8	3 17/32	8.69
3.27	7/8	12	23 25/32	34 1/4	14 13/16	25/32	1 9/32	2 3/8	3 31/32	9.5
3.27	7/8	18	29 3/4	46 7/32	20 13/16	25/32	1 9/32	2 3/8	3 31/32	12.15
4.54	1	6	19 5/8	23 25/32	9 1/4	15/16	1 1/2	3	4 5/8	9.59
4.54	1	12	25 9/16	35 25/32	15 1/4	15/16	1 1/2	3	4 19/32	12.68
4.54	1	18	31 17/32	47 27/32	21 1/4	15/16	1 1/2	3	4 19/32	16.03
4.5	1	24	37 1/2	59 25/32	27 1/4	15/16	1 1/2	3	4 9/16	16.58
6.9	1 1/4	12	28	38 25/32	15 5/32	1 5/32	1 7/8	3 19/32	5 23/32	20.46
6.9	1 1/4	18	33 15/16	50 11/16	21 5/32	1 5/32	1 7/8	3 19/32	5 11/16	24.5
6.9	1 1/4	24	39 31/32	60 7/32	27 5/32	1 5/32	1 7/8	3 19/32	5 11/16	26.7
9.71	1 1/2	12	29 3/4	40 9/32	15 25/32	1 9/32	2 5/32	4 5/32	6 1/8	31.3
9.71	1 1/2	18	36 1/32	52 9/16	21 25/32	1 9/32	2 5/32	4 5/32	6 9/32	34.8
9.71	1 1/2	24	41 15/16	64 13/32	27 25/32	1 9/32	2 5/32	4 5/32	6 3/16	37.7
12.7	1 3/4	18	40 5/32	54 15/16	22 23/32	1 17/32	2 3/8	4 23/32	7 3/4	51
12.7	1 3/4	24	46 1/8	67 1/16	28 23/32	1 17/32	2 3/8	4 23/32	7 23/32	58
16.8	2	24	49 25/32	70 1/4	29 7/16	1 13/16	2 23/32	5 25/32	9 3/32	89.7
27.2	2 1/2	24	56 5/16	76 5/32	31 9/16	2	3 5/32	6 1/2	10 25/32	141
34	2 3/4	24	57 3/32	78 9/32	31 9/16	2 1/4	3 5/16	7	11 3/16	194

INFO CAD



Green Pin® HH Turnbuckle

Turnbuckle with hook-hook end-fitting, generally to ASTM1145-92

- **Material:** drop forged high tensile steel SAE 1035 or 1045
- **Safety factor:** MBL equals 5 x WLL
- **Standard:** generally to ASTM F1145-92
formerly U.S. Federal Specification FF-T-791b
- **Finish:** hot dipped galvanized
- **Certification:** 2.1 2.2 3.1 MTC® CE



G-6312

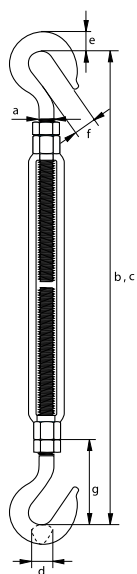

working load limit	diameter thread	take up	length closed position	length open position	thickness hook	thickness hook	opening hook	length closed position	weight each
t	a inch	inch	b mm	c mm	d mm	e mm	f mm	g mm	kg
0.54	3/8	6	278	415	13	16	15	42	0.53
1	1/2	6	305	434	16	22	16	48	0.93
1	1/2	9	380	587	16	22	16	47	1.16
0.68	1/2	12	456	739	13	19	16	47	1.34
1.59	5/8	6	356	479	16	23	21	67	0.98
1.59	5/8	9	431	632	20	24	21	66	1.96
1.59	5/8	12	507	784	16	23	21	66	1.71
2.36	3/4	6	393	511	22	27	24	79	1.53
1.36	3/4	9	468	664	20	27	24	78	1.88
2.36	3/4	12	544	816	22	27	24	78	3.27
2.36	3/4	18	696	1122	22	27	24	78	4.5
2.27	1	6	479	586	26	35	31	109	3.87
4.54	1	12	625	886	26	35	31	106	6.64
2.27	1	18	778	1191	26	35	31	106	6
2.27	1	24	928	1495	26	35	31	105	7.52

In inch

working load limit	diameter thread	take up	length closed position	length open position	thickness hook	thickness hook	opening hook	length closed position	weight each
t	a inch	inch	b inch	c inch	d inch	e inch	f inch	g inch	lbs
0.54	3/8	6	10 15/16	16 11/32	1/2	5/8	19/32	1 11/16	1.17
1	1/2	6	12	17 1/8	5/8	7/8	5/8	1 29/32	2.05
1	1/2	9	14 15/16	23 1/8	5/8	7/8	5/8	1 7/8	2.56
0.68	1/2	12	17 31/32	29 3/32	1/2	3/4	5/8	1 7/8	2.95
1.59	5/8	6	14	18 7/8	5/8	29/32	13/16	2 5/8	2.16
1.59	5/8	9	17	24 7/8	25/32	15/16	13/16	2 19/32	4.32
1.59	5/8	12	19 31/32	30 13/16	5/8	29/32	13/16	2 19/32	3.77
2.36	3/4	6	15 1/2	20 1/8	7/8	1 3/32	15/16	3 1/8	3.37
1.36	3/4	9	18 7/16	26 1/8	25/32	1 3/32	15/16	3 3/32	4.14
2.36	3/4	12	21 7/16	32 1/8	7/8	1 3/32	15/16	3 3/32	7.21
2.36	3/4	18	27 3/8	44 3/8	7/8	1 3/32	15/16	3 3/32	9.92
2.27	1	6	18 7/8	23 3/32	1 1/32	1 3/8	1 1/4	4 9/32	8.53
4.54	1	12	24 19/32	34 7/8	1 1/32	1 3/8	1 1/4	4 5/32	14.64
2.27	1	18	30 19/32	46 29/32	1 1/32	1 3/8	1 1/4	4 5/32	13.23
2.27	1	24	36 17/32	58 3/4	1 1/32	1 3/8	1 1/4	4 1/8	16.58

INFO CAD



Green Pin® EJ Turnbuckle

Turnbuckle with eye-jaw end-fitting and cotter pin or safety bolt (depending on size), generally to ASTM1145-92

- **Material:** drop forged high tensile steel SAE 1035 or 1045
- **Safety factor:** MBL equals 5 x WLL
- **Standard:** generally to ASTM F1145-92
formerly U.S. Federal Specification FF-T-791b
- **Finish:** hot dipped galvanized
- **Certification:** 2.1 2.2 3.1 MTC^a CE



G-6315

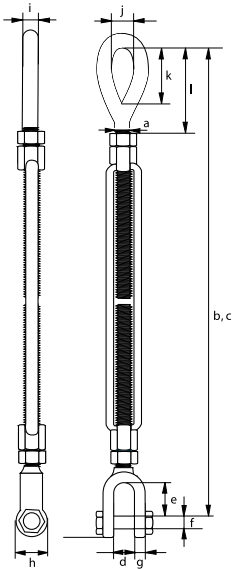

working load limit	diameter thread	take up	length closed position	length open position	opening jaw	length inside jaw	diameter pin jaw	thickness eye jaw	diameter eye jaw	diameter eye	width inside eye	length inside eye	length closed position	weight each
t	a inch	inch	b mm	c mm	d mm	e mm	f mm	g mm	h mm	i mm	j mm	k mm	l mm	kg
0.54	3/8	6	283	418	12	21	8	9	21	10	13	29	49	0.52
1	1/2	6	315	446	16	26	10	11	25	12	18	36	58	0.88
1	1/2	9	390	598	16	26	10	11	25	12	18	36	57	1.13
1.59	5/8	6	363	486	18	32	13	14	33	14	21	45	79	1.55
1.59	5/8	9	438	639	18	32	13	14	33	14	21	45	78	1.84
1.59	5/8	12	514	790	18	32	13	14	33	14	21	45	78	2.17
2.36	3/4	6	391	510	24	38	16	16	41	17	26	54	89	2.28
2.36	3/4	9	467	663	24	38	16	16	41	17	26	54	89	2.82
2.36	3/4	12	542	815	24	38	16	16	41	17	26	54	88	2.95
2.36	3/4	18	694	1120	24	38	16	16	41	17	26	54	89	3.30
3.27	7/8	12	583	848	27	42	19	19	48	20	32	61	101	4.35
3.27	7/8	18	735	1153	27	42	19	19	48	20	32	61	101	5.46
4.54	1	6	473	579	31	50	22	20	54	24	37	76	118	4.66
4.54	1	12	624	884	31	50	22	20	54	24	37	76	117	5.94
4.54	1	18	776	1190	31	50	22	20	54	24	37	76	117	7.98
4.5	1	24	928	1494	31	50	22	20	54	24	37	76	116	8.35
6.9	1 1/4	12	677	950	44	71	29	26	68	29	47	91	145	10.4
6.9	1 1/4	18	833	1258	44	71	29	26	68	29	47	91	144	11
6.9	1 1/4	24	989	1566	44	71	29	26	68	29	47	91	144	12.9
9.71	1 1/2	12	716	983	52	71	35	28	80	32	55	106	156	13.1
9.71	1 1/2	18	871	1290	52	71	35	28	80	32	55	106	160	14.7
9.71	1 1/2	24	1023	1594	52	71	35	28	80	32	55	106	158	17.8
12.7	1 3/4	18	979	1356	60	86	41	33	90	38	61	120	197	22.3
12.7	1 3/4	24	1130	1662	60	86	41	33	90	38	61	120	196	27.5
16.8	2	24	1208	1728	63	93	51	40	107	46	69	147	230	42.9
27.2	2 1/2	24	1343	1899	75	114	57	41	143	51	80	165	274	68
34	2 3/4	24	1399	1953	90	110	70	41	158	57	84	178	284	91

INFO CAD

continued on next page >



Green Pin® EJ Turnbuckle (continued)

Turnbuckle with eye-jaw end-fitting and cotter pin or safety bolt (depending on size), generally to ASTM1145-92



- **Material:** drop forged high tensile steel SAE 1035 or 1045
- **Safety factor:** MBL equals 5 x WLL
- **Standard:** generally to ASTM F1145-92
formerly U.S. Federal Specification FF-T-791b
hot dipped galvanized
- **Finish:** hot dipped galvanized
- **Certification:** 2.1 2.2 3.1 MTC[®] CE

In inch

working load limit	diameter thread	take up	length closed position	length open position	opening jaw	length inside jaw	diameter pin jaw	thickness eye jaw	diameter eye jaw	diameter eye	width inside eye	length inside eye	length closed position	length open position	weight each
t	a	b	c	d	e	f	g	h	i	j	k	l	l	l	lbs
	inch	inch	inch	inch	inch	inch	inch	inch	inch	inch	inch	inch	inch	inch	
0.54	3/8	6	11 5/32	16 1/2	15/32	13/16	5/16	11/32	13/16	13/32	1/2	1 5/32	1 15/16	1.15	
1	1/2	6	12 3/8	17 19/32	5/8	1 1/32	13/32	7/16	1	15/32	23/32	1 7/16	2 9/32	1.94	
1	1/2	9	15 11/32	23 9/16	5/8	1 1/32	13/32	7/16	1	15/32	23/32	1 7/16	2 1/4	2.49	
1	1/2	12	18 11/32	29 9/16	5/8	1 1/32	13/32	7/16	1	15/32	23/32	1 7/16	2 1/4	3.02	
1.59	5/8	6	14 9/32	19 5/32	23/32	1 9/32	1/2	9/16	1 5/16	9/16	13/16	1 25/32	3 1/8	3.42	
1.59	5/8	9	17 9/32	25 5/32	23/32	1 9/32	1/2	9/16	1 5/16	9/16	13/16	1 25/32	3 3/32	4.06	
1.59	5/8	12	20 1/4	31 5/32	23/32	1 9/32	1/2	9/16	1 5/16	9/16	13/16	1 25/32	3 3/32	4.78	
2.36	3/4	6	15 3/8	20 3/32	15/16	1 17/32	5/8	5/8	1 5/8	11/16	1 1/32	2 1/8	3 17/32	5.03	
2.36	3/4	9	18 3/8	26 3/32	15/16	1 17/32	5/8	5/8	1 5/8	11/16	1 1/32	2 1/8	3 17/32	6.22	
2.36	3/4	12	21 11/32	32 3/32	15/16	1 17/32	5/8	5/8	1 5/8	11/16	1 1/32	2 1/8	3 1/2	6.5	
2.36	3/4	18	27 5/16	44 3/32	15/16	1 17/32	5/8	5/8	1 5/8	11/16	1 1/32	2 1/8	3 17/32	7.28	
3.27	7/8	12	22 15/16	33 3/8	1 3/32	1 11/16	3/4	3/4	1 29/32	25/32	1 9/32	2 3/8	3 31/32	9.59	
3.27	7/8	18	28 29/32	45 13/32	1 3/32	1 11/16	3/4	3/4	1 29/32	25/32	1 9/32	2 3/8	3 31/32	12.04	
4.54	1	6	18 5/8	22 25/32	1 1/4	1 31/32	7/8	25/32	2 1/8	15/16	1 1/2	3	4 5/8	10.27	
4.54	1	12	24 9/16	34 25/32	1 1/4	1 31/32	7/8	25/32	2 1/8	15/16	1 1/2	3	4 19/32	13.1	
4.54	1	18	30 17/32	46 27/32	1 1/4	1 31/32	7/8	25/32	2 1/8	15/16	1 1/2	3	4 19/32	17.59	
4.5	1	24	36 17/32	58 13/16	1 1/4	1 31/32	7/8	25/32	2 1/8	15/16	1 1/2	3	4 9/16	18.41	
6.9	1 1/4	12	26 5/8	37 3/8	1 3/4	2 25/32	1 5/32	1 1/32	2 11/16	1 5/32	1 7/8	3 19/32	5 23/32	22.9	
6.9	1 1/4	18	32 25/32	49 17/32	1 3/4	2 25/32	1 5/32	1 1/32	2 11/16	1 5/32	1 7/8	3 19/32	5 11/16	24.3	
6.9	1 1/4	24	38 15/16	61 21/32	1 3/4	2 25/32	1 5/32	1 1/32	2 11/16	1 5/32	1 7/8	3 19/32	5 11/16	28.4	
9.71	1 1/2	12	28 5/32	38 23/32	2 1/32	2 25/32	1 3/8	1 1/8	3 5/32	1 9/32	2 5/32	4 5/32	6 1/8	28.9	
9.71	1 1/2	18	34 9/32	50 25/32	2 1/32	2 25/32	1 3/8	1 1/8	3 5/32	1 9/32	2 5/32	4 5/32	6 9/32	32.4	
9.71	1 1/2	24	40 9/32	60 3/4	2 1/32	2 25/32	1 3/8	1 1/8	3 5/32	1 9/32	2 5/32	4 5/32	6 3/16	39.2	
12.7	1 3/4	18	38 9/16	53 13/32	2 11/32	3 3/8	1 5/8	1 5/16	3 9/16	1 17/32	2 3/8	4 23/32	7 3/4	49.2	
12.7	1 3/4	24	44 1/2	65 7/16	2 11/32	3 3/8	1 5/8	1 5/16	3 9/16	1 17/32	2 3/8	4 23/32	7 23/32	60.6	
16.8	2	24	47 9/16	68 1/32	2 1/2	3 11/16	2	1 19/32	4 3/16	1 13/16	2 23/32	5 25/32	9 3/32	94.6	
27.2	2 1/2	24	52 7/8	74 25/32	2 15/16	4 1/2	2 1/4	1 5/8	5 5/8	2	3 5/32	6 1/2	10 25/32	150	
34	2 3/4	24	55 3/32	76 29/32	3 9/16	4 5/16	2 3/4	1 5/8	6 3/16	2 1/4	3 5/16	7	11 3/16	200	

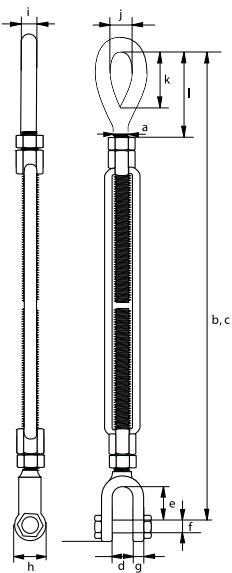

G-6315

INFO CAD



Green Pin® EH Turnbuckle

Turnbuckle with eye-hook end-fitting, generally to ASTM F1145-92

- **Material:** drop forged high tensile steel SAE 1035 or 1045
- **Safety factor:** MBL equals 5 x WLL
- **Standard:** generally to ASTM F1145-92
formerly U.S. Federal Specification FF-T-791b
- **Finish:** hot dipped galvanized
- **Certification:** 2.1 2.2 3.1 MTC[®] CE



G-6314

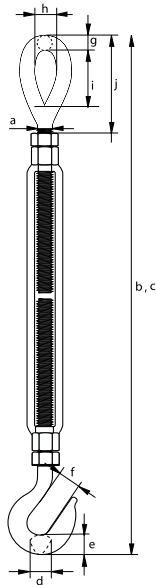

working load limit	diameter thread	take up	length closed position	length open position	thickness hook	thickness hook	opening hook	diameter eye	width inside eye	length inside eye	length closed position	weight each
t	a inch	inch	b mm	c mm	d mm	e mm	f mm	g mm	h mm	i mm	j mm	kg
0.54	3/8	6	285	422	13	16	15	10	13	29	49	0.47
1	1/2	6	315	445	16	22	16	12	18	36	58	0.82
1	1/2	9	390	598	16	22	16	12	18	36	57	1.06
0.68	1/2	12	466	750	13	19	16	12	18	36	57	1.28
1.59	5/8	6	368	491	16	23	21	14	21	45	79	1.31
1.59	5/8	9	443	644	20	24	21	14	21	45	78	1.56
1.59	5/8	12	519	796	16	23	21	14	21	45	78	1.71
2.36	3/4	6	403	521	22	27	24	17	26	54	89	2.04
1.36	3/4	9	479	675	20	27	24	17	26	54	89	4.49
2.36	3/4	12	554	827	22	27	24	17	26	54	88	2.3
2.36	3/4	18	707	1133	22	27	24	17	26	54	89	2.85
2.27	1	6	488	595	26	35	31	24	36	75	118	3.87
4.54	1	12	636	897	26	35	31	24	36	75	117	5.09
2.27	1	18	789	1202	26	35	31	24	36	75	117	6
2.27	1	24	939	1506	26	35	31	24	36	75	116	7.52

In inch

working load limit	diameter thread	take up	length closed position	length open position	thickness hook	thickness hook	opening hook	diameter eye	width inside eye	length inside eye	length closed position	weight each
t	a inch	inch	b inch	c inch	d inch	e inch	f inch	g inch	h inch	i inch	j inch	lbs
0.54	3/8	6	11 1/4	16 5/8	1/2	5/8	19/32	13/32	1/2	1 5/32	1 15/16	1.04
1	1/2	6	12 3/8	17 9/16	5/8	7/8	5/8	15/32	23/32	1 7/16	2 9/32	1.81
1	1/2	9	15 11/32	23 9/16	5/8	7/8	5/8	15/32	23/32	1 7/16	2 1/4	2.34
0.68	1/2	12	18 11/32	29 17/32	1/2	3/4	5/8	15/32	23/32	1 7/16	2 1/4	2.82
1.59	5/8	6	14 1/2	19 11/32	5/8	29/32	13/16	9/16	13/16	1 25/32	3 1/8	2.89
1.59	5/8	9	17 1/2	25 11/32	25/32	15/16	13/16	9/16	13/16	1 25/32	3 3/32	3.44
1.59	5/8	12	20 7/16	31 5/16	5/8	29/32	13/16	9/16	13/16	1 25/32	3 3/32	3.77
2.36	3/4	6	15 7/8	20 17/32	7/8	1 3/32	15/16	11/16	1 1/32	2 1/8	3 17/32	4.5
1.36	3/4	9	18 7/8	26 9/16	25/32	1 3/32	15/16	11/16	1 1/32	2 1/8	3 17/32	9.9
2.36	3/4	12	21 13/16	32 9/16	7/8	1 3/32	15/16	11/16	1 1/32	2 1/8	3 1/2	5.07
2.36	3/4	18	27 13/16	44 5/8	7/8	1 3/32	15/16	11/16	1 1/32	2 1/8	3 17/32	6.28
2.27	1	6	19 1/4	23 7/16	1 1/32	1 3/8	1 1/4	15/16	1 7/16	2 15/16	4 5/8	8.53
4.54	1	12	25 1/32	35 5/16	1 1/32	1 3/8	1 1/4	15/16	1 7/16	2 15/16	4 19/32	11.22
2.27	1	18	31 1/32	47 5/16	1 1/32	1 3/8	1 1/4	15/16	1 7/16	2 15/16	4 19/32	13.23
2.27	1	24	36 15/16	59 5/16	1 1/32	1 3/8	1 1/4	15/16	1 7/16	2 15/16	4 9/16	16.58

INFO CAD



Rigging screws Eye-Eye

According to DIN 1480

- **Material:** drop forged mild steel
- **Standard:** DIN 1480
- **Finish:** electro-galvanized
- **Certification:** 2.1



E-6351

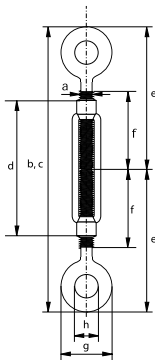

diameter thread	length closed position	length open position	length body	length end fitting	length thread	diameter eye outside	diameter eye inside	weight each
a mm	b mm	c mm	d mm	e mm	f mm	g mm	h mm	kg
5	114	170	70	57	35	16	8	0.07
6	160	246	110	80	55	20	9	0.11
8	168	248	110	84	57	22	10	0.2
10	210	300	125	105	68	31	14	0.28
12	222	305	125	110	70	35	16	0.43
14	244	334	140	123	75	40	18	0.61
16	300	416	170	143	88	47	22	1
20	334	466	200	165	105	52	24	1.6
22	372	527	220	185	118	60	27	2.2
24	410	587	255	208	135	65	27	2.8
30	440	605	255	220	135	71	31	4.1
33	490	690	295	245	148	88	36	6
36	554	740	295	277	158	94	38	8.5
42	600	800	330	300	170	110	49	11



Rigging screws Hook-Hook

According to DIN 1480

- **Material:** drop forged mild steel
- **Standard:** DIN 1480
- **Finish:** electro-galvanized
- **Certification:** 2.1



E-6352

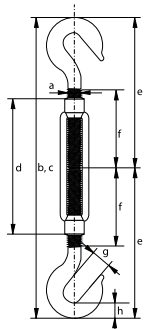

diameter thread	length closed position	length open position	length body	length end fitting	length thread	opening hook	thickness hook	weight each
a mm	b mm	c mm	d mm	e mm	f mm	g mm	h mm	kg
6	184	270	110	92	55	8	15	0.11
8	200	280	110	100	57	10.5	15	0.2
10	234	323	125	117	68	13	11	0.28
12	260	343	125	130	70	16	13	0.43
14	278	368	140	139	75	18	15	0.61
16	322	438	170	161	88	20	17	1
20	382	514	200	191	105	21	21	1.6
22	456	601	220	228	118	24	28	2.2
24	496	673	255	248	135	26	33	2.8
30	550	715	255	275	135	34	35	4.1
33	600	799	295	300	148	38	40	6
36	640	825	295	320	158	46	45	8.3

C

Rigging screws Eye-Hook

According to DIN 1480

- **Material:** drop forged mild steel
- **Standard:** DIN 1480
- **Finish:** electro-galvanized
- **Certification:** [2.1](#)

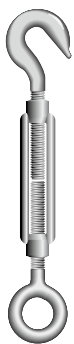

E-6354

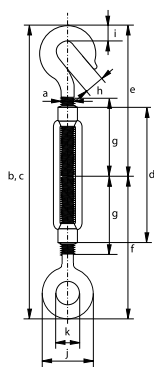

diameter thread	length closed position	length open position	length body	length end fitting	length end fitting	length thread	opening hook	thickness hook	diameter eye outside	diameter eye inside	weight each
a mm	b mm	c mm	d mm	e mm	f mm	g mm	h mm	i mm	j mm	k mm	kg
5	125	180	70	56	57	35	7	12	16	8	0.07
6	172	258	110	77	80	55	8	15	20	9	0.11
8	184	264	110	85	84	57	10.5	15	22	10	0.2
10	222	311	125	106	105	68	13	11	31	14	0.28
12	241	324	125	117	111	70	16	13	35	16	0.43
14	261	351	140	124	122	75	18	15	40	18	0.61
16	311	427	170	144	150	88	20	17	47	22	1
20	358	490	200	170	167	105	21	21	52	24	1.6
22	414	559	220	200	186	118	24	28	60	27	2.2
24	453	630	255	215	205	135	26	33	65	27	2.8
30	495	660	255	240	220	135	34	35	71	31	4.1
33	545	744	295	260	245	148	38	40	88	36	6
36	597	782	295	275	277	158	46	45	94	38	8.4

C

Rigging screws Jaw-Jaw

According to DIN 1480

- **Material:** drop forged mild steel
- **Standard:** DIN 1480
- **Finish:** electro-galvanized
- **Note:** supplied with locking nuts
- **Certification:** [2.1](#)



E-6353

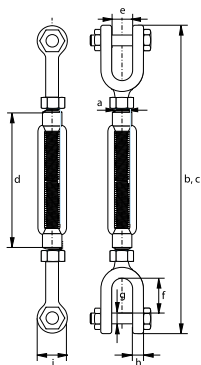

diameter thread	length closed position	length open position	length body	opening jaw	length inside	diameter pin	thickness jaw eye	diameter jaw eye	weight each
a mm	b mm	c mm	d mm	e mm	f mm	g mm	h mm	i mm	kg
6	191	277	110	7.5	12	M 6	5	13	0.16
8	194	274	110	8.5	12	M 6	6	14	0.21
10	236	325	125	11	16	M 8	8	18	0.38
12	266	349	125	13	20	M 10	10	24	0.66
14	316	406	140	16	30	M 12	12	28	1.15
16	374	490	170	18	38	M 12	12	32	1.45
20	438	570	200	20	42	M 16	16	38	2.61
22	466	611	220	22	44	M 18	18	40	3.24
24	514	691	255	24	46	M 20	20	42	4.35
30	544	709	255	30	50	M 24	22	46	6.48

C

Rigging screws with Welding Ends

According to DIN 1480

- **Material:** drop forged mild steel
- **Standard:** DIN 1480
- **Finish:** Body: electro-galvanized
Welding ends: self coloured
- **Certification:** 2.1



E-6355

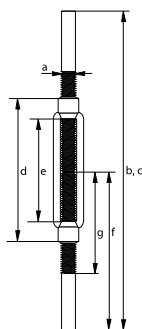

diameter thread	length closed position	length open position	length body	length body inside	length stub-ends	length thread	weight per 100 pcs
a mm	b mm	c mm	d mm	e mm	f mm	g mm	kg
6	240	326	110	86	120	65	9.3
8	240	320	110	80	120	65	14
10	300	389	125	89	150	75	29
12	300	383	125	83	150	75	40
14	330	420	140	90	165	85	66
16	400	516	170	116	200	100	89
20	440	572	200	132	220	120	160
22	440	585	220	145	220	130	227
24	520	697	255	177	260	150	282
30	520	685	255	165	260	160	423
36	600	780	295	185	300	180	710

C

Turnbuckles (hamburgers)

For deck lashing

- **Material:** mild steel
- **Finish:** self coloured
- **Certification:** 2.1



S-6330

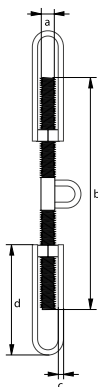

minimum breaking load	diameter thread	length thread	diameter bow	length bow	weight each
t	a mm	b mm	c mm	d mm	kg
13	24	400	16	210	2.8
13	24	500	16	260	3.8
18	27	400	18	210	4.4
18	27	500	18	260	5.5
20	30	400	20	210	5
20	30	500	20	260	6.3
21	36	400	20	210	7
21	36	500	20	260	8.8



Closed body rigging screws Jaw-Jaw

- **Material:** mild steel
- **Safety factor:** MBL equals 5 x WLL,
- **Finish:** hot dipped galvanized
- **Certification:** 2.1 2.2 CE
- **Note:** end fittings of 6 and 8 mm rigging screws are electro-galvanized



G-6343

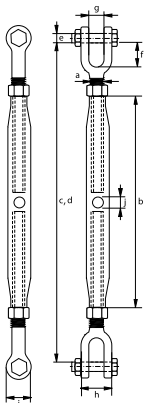

working load limit	diameter thread	length body	length closed position	length open position	diameter pin	length inside	opening jaw	width jaw	diameter jaw eye	diameter hole	weight each
t	a mm	b mm	c mm	d mm	e mm	f mm	g mm	h mm	i mm	j mm	kg
0.2	6	100	170	250	5	16	7	20	13	6	0.15
0.32	8	108	199	279	6	22	9	24	14	8	0.26
0.5	10	125	222	312	8	22	10.5	28	19	8	0.45
0.7	12	195	315	470	10	27	13	34	23	10	0.85
1.2	16	230	388	568	12	33	18	42	29	11	1.51
1.5	20	270	449	654	16	38	20	51	33	12	2.62
2.2	22	295	490	715	20	45	25	55	38	12	3.94
3.2	24	325	538	793	22	52	30	70	46	12	5.16
4.8	33	370	680	965	30	70	38	82	60	14	11.6
6	39	400	707	1002	33	70	45	85	76	15	14.2
8.5	45	400	761	1011	39	86	50	94	85	16	20.8
11	48	400	780	1005	45	97	58	98	92	16	24



Closed body rigging screws Eye-Eye

- **Material:** mild steel
- **Safety factor:** MBL equals 5 x WLL,
- **Finish:** hot dipped galvanized
- **Certification:** 2.1 2.2 CE
- **Note:** end fittings of 6 and 8 mm rigging screws are electro-galvanized

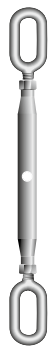

G-6340

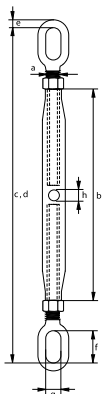

working load limit	diameter thread	length body	length closed position	length open position	diameter	length eye inside	width eye inside	diameter hole	weight each
t	a mm	b mm	c mm	d mm	e mm	f mm	g mm	h mm	kg
0.2	6	100	160	240	5.5	11	11	6	0.12
0.32	8	108	175	255	6	12	12	8	0.19
0.5	10	125	205	300	8.5	13	13	8	0.34
0.7	12	195	320	480	11	30	15	10	0.77
1.2	16	230	380	555	12	40	20	11	1.31
1.5	20	270	455	660	16	50	24	12	2.36
2.2	22	295	495	720	16	50	24	12	2.94
3.2	24	325	540	790	19	56	28	12	3.86
4.8	33	370	660	940	29	70	35	14	8.95
6	39	400	720	1020	35	80	40	15	11
8.5	45	400	721	879	31	49	49	16	13.4
11	48	400	767	1032	37	52	52	16	17.9

C

Closed body rigging screws Eye-Jaw

- **Material:** mild steel
- **Safety factor:** MBL equals 5 x WLL,
- **Finish:** hot dipped galvanized
- **Certification:** 2.1 2.2 CE
- **Note:** end fittings of 6 and 8 mm rigging screws are electro-galvanized



G-6345

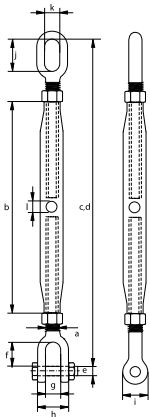

working load limit	diameter thread	length body	length closed position	length open position	diameter pin	length jaw inside	opening jaw	width jaw	diameter jaw eye	length eye inside	width eye inside	diameter hole	weight each
t	a mm	b mm	c mm	d mm	e mm	f mm	g mm	h mm	i mm	j mm	k mm	l mm	kg
0.2	6	100	165	247	5	16	7	20	13	11	11	6	0.14
0.32	8	108	187	267	6	22	9	24	14	12	12	8	0.24
0.5	10	125	214	306	8	22	10.5	28	19	13	13	8	0.53
0.7	12	195	317	475	10	27	13	34	23	30	15	10	0.83
1.2	16	230	384	562	12	33	18	42	29	40	20	11	1.49
1.5	20	270	452	657	16	38	20	51	33	50	24	12	2.54
2.2	22	295	493	717	20	45	25	55	38	50	24	12	3.34
3.2	24	325	539	791	22	52	30	70	46	56	28	12	4.65
4.8	33	370	670	952	30	70	38	82	60	70	35	14	10.5
6	39	400	714	1011	33	70	45	85	76	80	40	15	12.8
8.5	45	400	741	945	39	86	50	94	85	49	49	16	20.8
11	48	400	774	1018	45	97	58	98	92	52	52	16	24

LINKS



Applications

Connecting links are used in the manufacturing of chain slings. Master links are used in the manufacturing of 1 and 2 leg slings. Master link assemblies are used in the manufacturing of 3 and 4 leg slings.

Range

Green Pin® supplies a range of connecting links for 6-32 mm chain diameters, as well as a range of master links and master link assemblies. DNV GL master links are DNV GL type approved to certification note 2.7-1 (lifting sets for offshore containers, certificate TAS000013Z). There is also a Green Pin Tycan® connecting link available, which is compatible with Green Pin Tycan® Lifting Chain. Van Beest offers a wide range of other links to complement the Green Pin® assortment.

Design

Connecting links are supplied unassembled and ready for immediate use. Assembly is quick and easy. MS master links (up to 37 t) and type MTS master link assemblies (up to 50 t) are supplied with a flat part for easy connection of the master link to the sling or for easy assembly with the omega link. All master links and connecting links are suitable for lifting purposes.

Connecting links and master links are generally marked with:

- manufacturer's symbol - e.g. GP
- size in mm - e.g. 13 and/or 1/2"
- traceability code - e.g. HA
- steel grade - e.g. 8 or 10
- item code (specific products) - e.g. MJ
- origin (specific products) - e.g. France

DNV GL master links are designed for use in lifting sets for offshore containers.

Finish

All master links and connecting links are painted. Grade 8 products were painted yellow or red under the Excel® brand. However, grade 8 Links under the Green Pin® brand will be painted white. Grade 10 products are painted blue and will remain so.

Certification

Specific details of certificate availability can be found on each product page. Please verify your certification requirements with Green Pin® at the time of order.

Instructions for use

Connecting links, master links and master link assemblies should be inspected before use to ensure that:

- all markings are legible;
- the link and the assemblies are both made of the same steel grade;
- a link with the correct WLL has been selected with respect to the sling design. For further details, refer to the EN 818 standard for Chain Slings;
- the pin, bush or any other locking system cannot move or vibrate out of position;
- links, assemblies and connecting links are free from nicks, gouges and cracks;
- links, assemblies and connecting links are not heat treated (this may affect their Working Load Limit);
- all components of the sling are of the same steel grade;
- items are not distorted or unduly worn.

Also:

- only use the items for in-line lifting;
- never modify, repair or reshape an item by machining, welding, heating or bending, as this may affect the WLL.

Master links, master link assemblies and connecting links must be regularly inspected in accordance with the safety standards given in the country of use. This is required because the products in use may be affected by issues such as wear, misuse and overloading, which may lead to deformation and alteration of the material structure. Inspection should take place at least every six months, and more frequently when the links are used in severe operating conditions.



Green Pin® Master Link EN 1677-4 GR8

Grade 8 master link EN 1677-4



- **Material:** grade 8, alloy steel
- **Safety factor:** MBL equals 4 x WLL
- **Standard:** generally to EN 1677-4
- **Finish:** painted yellow, red or white
- **Temperature range:** -40°C up to +200°C
- **Certification:** 2.1 2.2 3.1 MTC[®]
- **Note:** from 50 t without flat part

MS

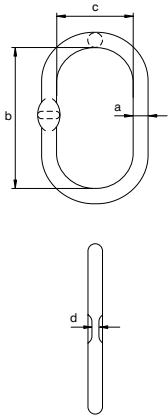

diameter	diameter chain 1 leg	diameter chain 2 legs			working load limit	length inside	width inside	thickness	weight each
		$\beta \leq 45^\circ$	$\beta \leq 60^\circ$						
a	mm	mm	mm	t	b	c	d	kg	
13	6 - 7	6	6 - 7	1.6	100	60	7	0.33	
16	8	7 - 8	8	3.2	120	70	7	0.56	
18	10	10	10	4.5	135	75	9	0.8	
20	13	-	13	6.2	150	90	9	1.11	
22	16	13	16	8.2	150	90	11	1.36	
25	18	-	18	10.6	170	95	13	1.96	
28	20	16	19	12.8	200	120	13	2.92	
30	20 - 22	18	20 - 22	15.5	200	120	17	3.4	
36	-	19 - 20	-	20	250	150	17	6.1	
38	26	22	26	25	250	150	21	6.8	
44	-	26	-	30	280	170	21	10.8	
45	32	-	32	37	300	200	23	11.7	
50	-	32	-	50	300	200	-	14.75	
55	-	-	-	63	350	200	-	20	
70	-	-	-	100	400	250	-	39	
80	-	-	-	125	400	250	-	52	

In inch

diameter	diameter chain 1 leg	diameter chain 2 legs			working load limit	length inside	width inside	thickness	weight each
		$\beta \leq 30$	$\beta \leq 45^\circ$	$\beta \leq 60^\circ$					
a	inch	inch	inch	t	b	c	d	lbs	
$\frac{1}{2}$	$\frac{7}{32} - \frac{1}{4}$	-	$\frac{7}{32}$	$\frac{7}{32} - \frac{1}{4}$	1.6	$3 \frac{15}{16}$	$2 \frac{3}{8}$	$\frac{9}{32}$	0.73
$\frac{5}{8}$	$\frac{3}{8}$	$\frac{7}{32} - \frac{1}{4}$	$\frac{1}{4} - \frac{5}{16}$	$\frac{5}{16}$	3.2	$4 \frac{23}{32}$	$2 \frac{3}{4}$	$\frac{9}{32}$	1.23
$\frac{23}{32}$	$\frac{3}{8}$	$\frac{5}{16}$	$\frac{3}{8}$	$\frac{3}{8}$	4.5	$5 \frac{5}{16}$	$2 \frac{15}{16}$	$\frac{11}{32}$	1.76
$\frac{25}{32}$	$\frac{1}{2}$	$\frac{3}{8}$	-	$\frac{1}{2}$	6.2	$5 \frac{29}{32}$	$3 \frac{17}{32}$	$\frac{11}{32}$	2.45
$\frac{7}{8}$	$\frac{5}{8}$	-	$\frac{1}{2}$	$\frac{5}{8}$	8.2	$5 \frac{29}{32}$	$3 \frac{17}{32}$	$\frac{7}{16}$	2.99
$\frac{31}{32}$	$\frac{3}{4}$	$\frac{1}{2}$	-	$\frac{3}{4}$	10.6	$6 \frac{11}{16}$	$3 \frac{3}{4}$	$\frac{1}{2}$	4.32
$1 \frac{3}{32}$	$\frac{3}{4}$	-	$\frac{5}{8}$	$\frac{3}{4}$	12.8	$7 \frac{7}{8}$	$4 \frac{23}{32}$	$\frac{1}{2}$	6.44
$1 \frac{3}{16}$	$\frac{3}{4} - \frac{7}{8}$	$\frac{5}{8}$	$\frac{3}{4}$	$\frac{3}{4} - \frac{7}{8}$	15.5	$7 \frac{7}{8}$	$4 \frac{23}{32}$	$\frac{21}{32}$	7.5
$1 \frac{13}{32}$	-	$\frac{3}{4}$	$\frac{3}{4}$	-	20	$9 \frac{27}{32}$	$5 \frac{29}{32}$	$\frac{21}{32}$	13.5
$1 \frac{1}{2}$	1	$\frac{3}{4}$	$\frac{7}{8}$	1	25	$9 \frac{27}{32}$	$5 \frac{29}{32}$	$\frac{13}{16}$	15
$1 \frac{23}{32}$	-	$\frac{7}{8}$	1	-	30	$11 \frac{1}{32}$	$6 \frac{11}{16}$	$\frac{13}{16}$	23.8
$1 \frac{25}{32}$	$1 \frac{1}{4}$	1	-	$1 \frac{1}{4}$	37	$11 \frac{13}{16}$	$7 \frac{7}{8}$	$\frac{29}{32}$	25.8
$1 \frac{31}{32}$	-	-	$1 \frac{1}{4}$	-	50	$11 \frac{13}{16}$	$7 \frac{7}{8}$	-	32.5
$2 \frac{5}{32}$	-	$1 \frac{1}{4}$	-	-	63	$13 \frac{25}{32}$	$7 \frac{7}{8}$	-	44.1
$2 \frac{3}{4}$	-	-	-	-	100	$15 \frac{3}{4}$	$9 \frac{27}{32}$	-	86
$3 \frac{5}{32}$	-	-	-	-	125	$15 \frac{3}{4}$	$9 \frac{27}{32}$	-	115

Green Pin® Master Link Assembly EN 1677-4 GR8

Grade 8 master link assembly EN 1677-4

- **Material:** grade 8, alloy steel
- **Safety factor:** MBL equals 4 x WLL
- **Standard:** generally to EN 1677-4
- **Finish:** painted yellow, red or white
- **Temperature range:** -40°C up to +200°C
- **Certification:** 2.1 2.2 3.1 MTC^b
- **Note:** from 60 t without flat part



MTS

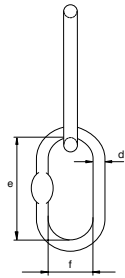
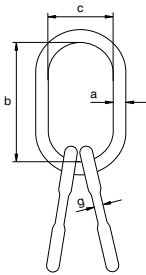

diameter	diameter chain 3/4 legs		working load limit	length inside	width inside	diameter	length inside	width inside	thickness	weight each
a mm	$\beta \leq 45^\circ$ mm	$\beta \leq 60^\circ$ mm	t	b mm	c mm	d mm	e mm	f mm	g mm	kg
16	6	6-7	2.5	120	70	13	100	60	7	1.16
18	6-7	8	3.5	135	75	16	100	60	6	1.75
22	8	10	6.5	150	90	18	120	70	9	2.8
25	10	13	8.5	170	95	20	120	70	11	3.82
28	-	-	10	200	120	20	120	70	11	4.7
30	13	16	13	200	120	22	135	75	14	5.85
36	16	18-19	17	250	150	25	135	75	14	9.35
38	-	20	20	250	150	28	170	95	17	11.75
45	18-20	22	27	280	170	33	200	120	17	18.5
45	-	-	30	300	200	36	200	120	21	22
50	22	26	40	300	200	38	150	90	21	24
55	26	32	50	300	200	38	150	90	23	27
58	-	-	60	350	200	42	150	90	-	34
70	32	-	80	400	250	55	300	150	-	72
80	-	-	100	400	250	58	300	150	-	92

In inch

diameter	diameter chain 3/4 legs			working load limit	length inside	width inside	diameter	length inside	width inside	thickness	weight each
a inch	$\beta \leq 30$ inch	$\beta \leq 45^\circ$ inch	$\beta \leq 60^\circ$ inch	t	b inch	c inch	d inch	e inch	f inch	g inch	lbs
$\frac{5}{8}$	-	$\frac{7}{32}$	$\frac{7}{32} - \frac{1}{4}$	2.5	$4 \frac{23}{32}$	$2 \frac{3}{4}$	$\frac{1}{2}$	$3 \frac{15}{16}$	$2 \frac{3}{8}$	$\frac{9}{32}$	2.56
$\frac{23}{32}$	$\frac{7}{32}$	$\frac{7}{32} - \frac{1}{4}$	$\frac{5}{16}$	3.5	$5 \frac{5}{16}$	$2 \frac{15}{16}$	$\frac{5}{8}$	$3 \frac{15}{16}$	$2 \frac{3}{8}$	$\frac{1}{4}$	3.86
$\frac{7}{8}$	$\frac{1}{4} - \frac{5}{16}$	$\frac{5}{16}$	$\frac{3}{8}$	6.5	$5 \frac{29}{32}$	$3 \frac{17}{32}$	$\frac{23}{32}$	$4 \frac{23}{32}$	$2 \frac{3}{4}$	$\frac{11}{32}$	6.17
$\frac{31}{32}$	$\frac{3}{8}$	$\frac{3}{8}$	$\frac{1}{2}$	8.5	$6 \frac{11}{16}$	$3 \frac{3}{4}$	$\frac{25}{32}$	$4 \frac{23}{32}$	$2 \frac{3}{4}$	$\frac{7}{16}$	8.42
$1 \frac{3}{32}$	-	-	-	10	$7 \frac{7}{8}$	$4 \frac{23}{32}$	$\frac{25}{32}$	$4 \frac{23}{32}$	$2 \frac{3}{4}$	$\frac{7}{16}$	10.4
$1 \frac{3}{16}$	-	$\frac{1}{2}$	$\frac{5}{8}$	13	$7 \frac{7}{8}$	$5 \frac{29}{32}$	$\frac{7}{8}$	$5 \frac{5}{16}$	$2 \frac{15}{16}$	$\frac{9}{16}$	12.9
$1 \frac{13}{32}$	$\frac{1}{2}$	$\frac{5}{8}$	$\frac{3}{4}$	17	$9 \frac{27}{32}$	$5 \frac{29}{32}$	$\frac{31}{32}$	$5 \frac{5}{16}$	$2 \frac{15}{16}$	$\frac{9}{16}$	20.6
$1 \frac{1}{2}$	-	-	$\frac{3}{4}$	20	$9 \frac{27}{32}$	$5 \frac{29}{32}$	$1 \frac{3}{32}$	$6 \frac{11}{16}$	$3 \frac{3}{4}$	$\frac{21}{32}$	25.9
$1 \frac{25}{32}$	$\frac{5}{8} - \frac{3}{4}$	$\frac{3}{4}$	$\frac{7}{8}$	27	$11 \frac{1}{32}$	$6 \frac{11}{16}$	$1 \frac{5}{16}$	$7 \frac{7}{8}$	$4 \frac{23}{32}$	$\frac{21}{32}$	40.8
$1 \frac{25}{32}$	$\frac{3}{4}$	-	-	30	$11 \frac{13}{16}$	$7 \frac{7}{8}$	$1 \frac{13}{32}$	$7 \frac{7}{8}$	$4 \frac{23}{32}$	$\frac{13}{16}$	48.5
$1 \frac{31}{32}$	$\frac{3}{4} - \frac{7}{8}$	$\frac{7}{8}$	1	40	$11 \frac{13}{16}$	$7 \frac{7}{8}$	$1 \frac{1}{2}$	$9 \frac{27}{32}$	$3 \frac{17}{32}$	$\frac{13}{16}$	52.9
$2 \frac{5}{32}$	-	1	$1 \frac{1}{4}$	50	$11 \frac{13}{16}$	$7 \frac{7}{8}$	$1 \frac{1}{2}$	$9 \frac{27}{32}$	$3 \frac{17}{32}$	$\frac{29}{32}$	59.5
$2 \frac{9}{32}$	1	-	-	60	$13 \frac{25}{32}$	$7 \frac{7}{8}$	$1 \frac{1}{2}$	$9 \frac{27}{32}$	$3 \frac{17}{32}$	-	75
$2 \frac{3}{4}$	-	$1 \frac{1}{4}$	-	80	$15 \frac{3}{4}$	$9 \frac{27}{32}$	$2 \frac{5}{32}$	$11 \frac{13}{16}$	$5 \frac{29}{32}$	-	159
$3 \frac{5}{32}$	$1 \frac{1}{4}$	-	-	100	$15 \frac{3}{4}$	$9 \frac{27}{32}$	$2 \frac{9}{32}$	$11 \frac{13}{16}$	$5 \frac{29}{32}$	-	203



Green Pin® Omega Link EN 1677-1 GR8

Grade 8 omega link EN 1677-1

- **Material:** alloy steel, grade 8, quenched and tempered
- **Safety factor:** MBL equals 4 x WLL
- **Standard :** EN 1677-1
- **Finish:** painted yellow (J), red (R) or white
- **Temperature range:** -40°C up to +200°C
- **Certification:** 2.1 2.2 3.1 MPI^b DGUV



CO

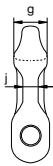
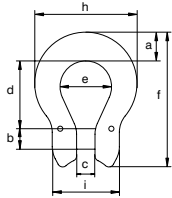

for chain diameter		working load limit	width	diameter pin	width	length inside	width bow	length outside	thickness	width outside	width outside	thickness	weight each
mm	inch		a mm	b mm	c mm	d mm	e mm	f mm	g mm	h mm	i mm	j mm	
5	³ / ₁₆	0.8	14	6	7	26	20	53	13	41	28	6	0.07
6	⁷ / ₃₂	1.12	14	8	7	25	20	53	13	41	28	6	0.07
7-8	¹ / ₄ - ⁵ / ₁₆	2	20	9	9	34	24	71	16	55	32	9	0.20
10	³ / ₈	3.2	19	13	12	40	31	82	17	63	42	11	0.28
13	¹ / ₂	5.4	25	16	15	51	40	106	20	84	54	14	0.64
16	⁵ / ₈	8.2	32	20	19	64	48	132	25	104	68	17	1.28
18-20	³ / ₄	12.8	38	24	23	80	59	163	30	126	82	22	2.25



Green Pin® Pear Shaped Link EN 1677-4 GR8

Grade 8 pear shaped link EN 1677-4

- **Material:** alloy steel, grade 8, quenched and tempered
- **Safety factor:** MBL equals 4 x WLL
- **Standard:** EN 1677-4
- **Finish:** painted yellow (J), red (R) or white
- **Temperature range:** -40°C up to +200°C
- **Certification:** 2.1 2.2 3.1 MPI^b



MP

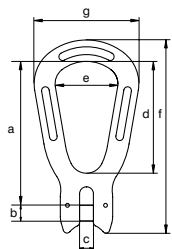

for chain diameter		working load limit	length	diameter pin	width	length inside	width inside	length	width outside	weight each
mm	inch		a mm	b mm	c mm	d mm	e mm	f mm	g mm	
5	³ / ₁₆	0.8	85	6	7	64	33	109	55	0.14
6	⁷ / ₃₂	1.12	84	8	7	64	33	109	55	0.14
7-8	¹ / ₄ - ⁵ / ₁₆	2	101	9	9	77	40	132	69	0.34
10	³ / ₈	3.2	125	13	12	97	50	165	84	0.77
13	¹ / ₂	5.4	161	16	15	125	66	213	110	1.62
16	⁵ / ₈	8.2	198	20	19	154	84	262	140	2.72
18-20	³ / ₄	12.8	253	24	23	198	104	331	166	4.28

Green Pin® Connecting Link EN 1677-1 GR8

Grade 8 connecting link EN 1677-1

- **Material:** alloy steel, grade 8, quenched and tempered
- **Safety factor:** MBL equals 4 x WLL
- **Standard:** EN 1677-1
- **Finish:** painted yellow (J), red (R) or white
- **Temperature range:** -40°C up to +200°C
- **Certification:** 2.1 2.2 3.1 MPI[®] DGUV



MJ

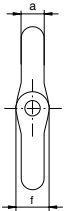
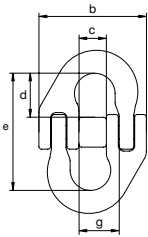

for chain diameter		working load limit	diameter	width outside	width inside	length inside	length inside	diameter eye	width inside	weight each
mm	inch		a mm	b mm	c mm	d mm	e mm	f mm	g mm	
6	$\frac{7}{32}$	1.12	8	42	11	20	52	11	15	0.09
7-8	$\frac{1}{4} - \frac{5}{16}$	2	9	53	14	20	55	13	19	0.15
10	$\frac{3}{8}$	3.2	10	66	18	23	64	18	23	0.28
13	$\frac{1}{2}$	5.4	14	83	21	32	85	24	28	0.63
16	$\frac{5}{8}$	8.2	17	103	25	40	105	28	34	1.16
18-20	$\frac{3}{4}$	12.8	21	120	33	50	129	33	42	1.95
22	$\frac{7}{8}$	15.5	23	143	40	55	140	37	51	2.94
26	1	21.6	26	160	45	60	153	46	57	4.12
32	$1\frac{1}{4}$	32.8	39	197	52	68	174	56	67	8.3

INFO



Green Pin® Round Web Sling Connector GR8

Grade 8 round web sling connector

- **Material:** alloy steel, grade 8, quenched and tempered
- **Safety factor:** MBL equals 4 x WLL
- **Finish:** painted yellow or white
- **Temperature range:** -40°C up to +200°C
- **Certification:** 2.1 2.2 3.1 MPI[®]



COS

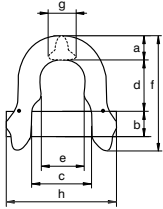

working load limit	width	diameter pin	width	length inside	width inside	length outside	thickness	width outside	weight each
t	a mm	b mm	c mm	d mm	e mm	f mm	g mm	h mm	kg
2	14	9	33	35	23	66	15	59	0.18
3.2	18	13	44	45	30	86	20	75	0.37
5.4	22	16	57	59	38	107	25	94	0.72
8.2	28	20	70	72	48	133	31	117	1.35

Example combinations with COS:



MS + CO + COS



COS + XLC



COS + CSC



Green Pin® Round Web Sling Connecting Link GR8

Grade 8 round web sling connecting link

- **Material:** alloy steel, grade 8, quenched and tempered
- **Safety factor:** MBL equals 4 x WLL
- **Finish:** painted yellow (J), red (R) or white
- **Temperature range:** -40°C up to +200°C
- **Certification:** 2.1 2.2 3.1



MJS

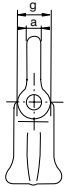
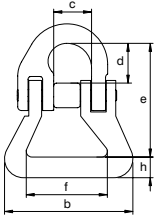

for chain diameter		working load limit	diameter	width outside	width inside	length inside	length	width inside	diameter eye	thickness	weight each
mm	inch		a mm	b mm	c mm	d mm	e mm	f mm	g mm	h mm	kg
7-8	1/4 - 5/16	2	9	66	19	21	61	40	14	14	0.31
10	3/8	3.2	12	76	25	24	74	45	19	15	0.51
13	1/2	5.4	16	87	30	30	91	51	24	19	1.01



Green Pin® Master Link GR10

Grade 10 master link

- **Material:** alloy steel, grade 10, quenched and tempered
- **Safety factor:** MBL equals 4 x WLL
- **Finish:** painted blue
- **Temperature range:** -40°C up to +200°C
- **Certification:** 2.1 2.2 3.1 MTC[®]



UMS

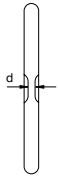
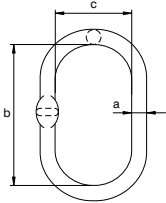

diameter	diameter chain 1 leg	diameter chain 2 legs		working load limit	length inside	width inside	thickness	weight each
a mm	mm	$\beta \leq 45^\circ$ mm	$\beta \leq 60^\circ$ mm	t	b mm	c mm	d mm	kg
13	6	6	6	2	100	60	7	0.33
16	8	-	8	3.2	120	70	7	0.56
18	10	8	10	5.4	135	75	9	0.8
22	13	10	13	8.2	170	90	11	1.47
25	16	13	16	11.2	190	105	13	2.17
30	20	16	20	16	235	125	17	3.82
40	22	20-22	22	27.6	290	160	21	9

In inch

diameter	diameter chain 1 leg	diameter chain 2 legs			working load limit	length inside	width inside	thickness	weight each
a inch	inch	$\beta \leq 30$ inch	$\beta \leq 45^\circ$ inch	$\beta \leq 60^\circ$ inch	t	b inch	c inch	d inch	lbs
$\frac{1}{2}$	$\frac{7}{32}$	-	$\frac{7}{32}$	$\frac{7}{32}$	2	$3 \frac{15}{16}$	$2 \frac{3}{8}$	$\frac{9}{32}$	0.73
$\frac{5}{8}$	$\frac{9}{32} - \frac{5}{16}$	$\frac{7}{32}$	-	$\frac{9}{32} - \frac{5}{16}$	3.2	$4 \frac{23}{32}$	$2 \frac{3}{4}$	$\frac{9}{32}$	1.23
$\frac{23}{32}$	$\frac{3}{8}$	$\frac{9}{32} - \frac{5}{16}$	$\frac{9}{32} - \frac{5}{16}$	$\frac{3}{8}$	5.4	$5 \frac{5}{16}$	$2 \frac{15}{16}$	$\frac{11}{32}$	1.76
$\frac{7}{8}$	$\frac{1}{2}$	$\frac{3}{8}$	$\frac{3}{8}$	$\frac{1}{2}$	8.2	$6 \frac{11}{16}$	$3 \frac{17}{32}$	$\frac{7}{16}$	3.24
$\frac{31}{32}$	$\frac{5}{8}$	-	$\frac{1}{2}$	$\frac{5}{8}$	11.2	$7 \frac{15}{32}$	$4 \frac{1}{8}$	$\frac{1}{2}$	4.78
$1 \frac{3}{16}$	$\frac{3}{4}$	-	$\frac{5}{8}$	$\frac{3}{4}$	16	$9 \frac{1}{4}$	$4 \frac{29}{32}$	$\frac{21}{32}$	8.42
$1 \frac{9}{16}$	$\frac{7}{8}$	$\frac{3}{4}$	$\frac{3}{4} - \frac{7}{8}$	$\frac{7}{8}$	27.6	$11 \frac{13}{32}$	$6 \frac{5}{16}$	$\frac{13}{16}$	19.8

Green Pin® Master Link Assembly GR10

Grade 10 master link assembly

- **Material:** alloy steel, grade 10, quenched and tempered
- **Safety factor:** MBL equals 4 x WLL
- **Finish:** painted blue
- **Temperature range:** -40°C up to +200°C
- **Certification:** 2.1 2.2 3.1 MTC^b



UMTS

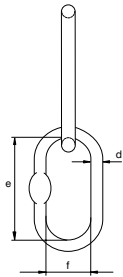
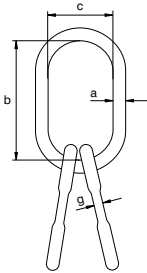

diameter	diameter chain 3/4 legs		working load limit	length inside	width inside	diameter	length inside	width inside	thickness	weight each
a mm	$\beta \leq 45^\circ$ mm	$\beta \leq 60^\circ$ mm								
18	6	6	3.5	135	75	16	100	60	7	1.75
22	8	8-10	6.5	170	90	18	120	70	9	2.91
28	10	13	11	210	115	20	120	70	11	4.74
36	13	16	17.5	270	150	25	135	75	13	9.6
38	16	18-19	21.2	285	160	30	170	95	16	13.38
50	20	22	41.6	300	200	38	170	95	21	24.5

In inch

diameter	diameter chain 3/4 legs			working load limit	length inside	width inside	diameter	length inside	width inside	thickness	weight each
a mm	$\beta \leq 30$ mm	$\beta \leq 45^\circ$ mm	$\beta \leq 60^\circ$ mm								
$\frac{23}{32}$	-	$\frac{7}{32}$	$\frac{7}{32}$	3.5	$5 \frac{5}{16}$	$2 \frac{15}{16}$	$\frac{5}{8}$	$3 \frac{15}{16}$	$2 \frac{3}{8}$	$\frac{9}{32}$	3.86
$\frac{7}{8}$	$\frac{9}{32} - \frac{5}{16}$	$\frac{9}{32} - \frac{5}{16}$	$\frac{9}{32} - \frac{3}{8}$	6.5	$6 \frac{11}{16}$	$3 \frac{17}{32}$	$\frac{23}{32}$	$4 \frac{23}{32}$	$2 \frac{3}{4}$	$\frac{11}{32}$	6.42
$1 \frac{3}{32}$	$\frac{3}{8}$	$\frac{3}{8}$	$\frac{1}{2}$	11	$8 \frac{9}{32}$	$4 \frac{17}{32}$	$\frac{25}{32}$	$4 \frac{23}{32}$	$2 \frac{3}{4}$	$\frac{7}{16}$	10.5
$1 \frac{13}{32}$	$\frac{1}{2}$	$\frac{1}{2}$	$\frac{5}{8}$	17.5	$10 \frac{5}{8}$	$5 \frac{29}{32}$	$\frac{31}{32}$	$5 \frac{5}{16}$	$2 \frac{15}{16}$	$\frac{1}{2}$	21.2
$1 \frac{1}{2}$	-	$\frac{5}{8}$	$\frac{3}{4}$	21.2	$11 \frac{7}{32}$	$6 \frac{5}{16}$	$1 \frac{3}{16}$	$6 \frac{11}{16}$	$3 \frac{3}{4}$	$\frac{5}{8}$	29.5
$1 \frac{31}{32}$	$\frac{3}{4}$	$\frac{3}{4}$	$\frac{7}{8}$	41.6	$11 \frac{13}{16}$	$7 \frac{7}{8}$	$1 \frac{3}{16}$	$6 \frac{11}{16}$	$3 \frac{3}{4}$	$\frac{13}{16}$	53.9



Green Pin® Omega Link GR10

Grade 10 omega link



UCO

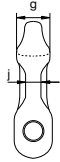
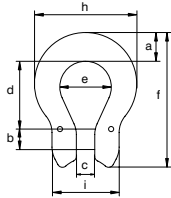

- **Material:** alloy steel, grade 10, quenched and tempered
- **Safety factor:** MBL equals 4 x WLL
- **Finish:** painted blue
- **Temperature range:** -40°C up to +200°C
- **Certification:** 2.1 2.2 3.1 MPI^b DGUV

for chain diameter		working load limit	width	diameter pin	width	length inside	width bow	length outside	thickness	width outside	width outside	thickness	weight each
mm	inch		a mm	b mm	c mm	d mm	e mm	f mm	g mm	h mm	i mm	j mm	kg
6	⁷ / ₃₂	1.4	14	8	7	25	20	53	13	41	28	6	0.07
	⁹ / ₃₂	1.95	21	10	9	34	24	72	16	58	32	9	0.18
8	⁵ / ₁₆	2.6	21	10	9	34	24	72	16	58	32	9	0.18
10	³ / ₈	4	21	13	12	40	31	84	19	67	42	11	0.28
13	¹ / ₂	6.8	28	16	15	51	40	109	23	90	54	14	0.64
16	⁵ / ₈	10.3	35	20	19	64	48	135	27	110	68	17	1.21



Green Pin® Pear Shaped Link GR10

Grade 10 pear shaped link

- **Material:** alloy steel, grade 10, quenched and tempered
- **Safety factor:** MBL equals 4 x WLL
- **Finish:** painted blue
- **Temperature range:** -40°C up to +200°C
- **Certification:** 2.1 2.2 3.1 MPI[®]



UMP

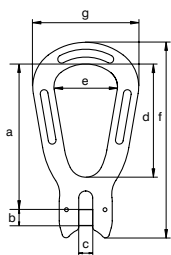

for chain diameter		working load limit	length	diameter pin	width	length inside	width inside	length	width outside	weight each
mm	inch									
6	⁷ / ₃₂	1.4	84	8	7	64	33	109	55	0.14
	⁹ / ₃₂	1.95	100	10	9	77	40	132	69	0.28
8	⁵ / ₁₆	2.6	100	10	9	77	40	132	69	0.28
10	³ / ₈	4	125	13	12	97	50	165	84	0.63
13	¹ / ₂	6.8	161	16	15	125	66	213	110	1.4
16	⁵ / ₈	10.3	198	20	19	154	84	262	140	2.72



Green Pin® Connecting Link GR10

Grade 10 connecting link

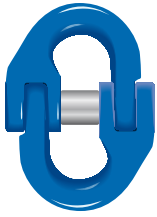

UMJ

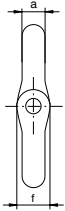
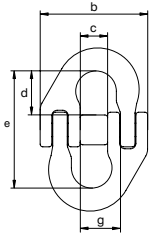

- **Material:** alloy steel, grade 10, quenched and tempered
- **Safety factor:** MBL equals 4 x WLL
- **Finish:** painted blue
- **Temperature range:** -40°C up to +200°C
- **Certification:** 2.1 2.2 3.1 MPI^b DGUV

for chain diameter		working load limit t	diameter	width outside	width inside	length inside	length inside	diameter eye	width inside	weight each
mm	inch		a mm	b mm	c mm	d mm	e mm	f mm	g mm	kg
6	$\frac{7}{32}$	1.4	8	42	11	20	52	11	15	0.09
8	$\frac{5}{16}$	2.6	9	57	14	20	55	16	19	0.18
10	$\frac{3}{8}$	4	12	66	18	23	64	18	23	0.31
13	$\frac{1}{2}$	6.8	16	83	21	32	85	24	28	0.68
16	$\frac{5}{8}$	10.3	19	103	25	40	105	28	34	1.27
20	$\frac{3}{4}$	16	23	122	33	49	128	38	42	2.27

INFO



Green Pin TyCan® Connecting Link GR10

Grade 10 connecting link

- **Material:** alloy steel, grade 10, quenched and tempered
- **Safety factor:** MBL equals 4 x WLL
- **Finish:** painted blue
- **Temperature range:** -40°C up to +200°C
- **Certification:** 2.1 2.2 3.1 MPI[®]

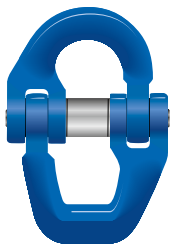

UMJT

for chain size	working load limit	diameter	width outside	width inside	length inside	length inside	diameter eye	width inside	diameter	weight each
mm	t	a mm	b mm	c mm	d mm	e mm	f mm	g mm	h mm	kg
11x15	2.6	9	57	14	20	55	16	19	13	0.21
11x20	4	12	66	18	23	64	18	23	16	0.36
13x30	6.8	16	83	21	32	85	24	28	20	0.75

In inch

for chain size	working load limit	diameter	width outside	width inside	length inside	length inside	diameter eye	width inside	diameter	weight each
mm	t	a inch	b inch	c inch	d inch	e inch	f inch	g inch	h inch	lbs
$\frac{7}{16} \times \frac{19}{32}$	2.6	$\frac{11}{32}$	$2 \frac{1}{4}$	$\frac{9}{16}$	$\frac{25}{32}$	$2 \frac{5}{32}$	$\frac{5}{8}$	$\frac{3}{4}$	$\frac{1}{2}$	0.46
$\frac{7}{16} \times \frac{25}{32}$	4	$\frac{15}{32}$	$2 \frac{19}{32}$	$\frac{23}{32}$	$\frac{29}{32}$	$2 \frac{17}{32}$	$\frac{23}{32}$	$\frac{29}{32}$	$\frac{5}{8}$	0.79
$\frac{1}{2} \times 1 \frac{3}{16}$	6.8	$\frac{5}{8}$	$3 \frac{9}{32}$	$\frac{13}{16}$	$1 \frac{1}{4}$	$3 \frac{11}{32}$	$\frac{15}{16}$	$1 \frac{1}{8}$	$\frac{25}{32}$	1.65

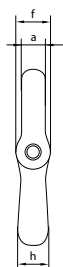
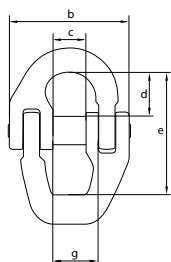

C

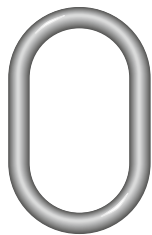

P-6810

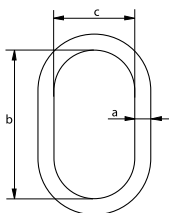

DNV GL Master Link

- **Material:** alloy steel, grade 8
- **Safety Factor:** MBL equals 5 x WLL
- **Standard:** DNV 2.7-1, EN 12079-2 and EN 1677-4
- **Finish:** painted orange
- **Temperature range:** -20°C up to +200°C
- **Certification:** 2.1 2.2 3.1 MTC[®] DNV GL 2.7-1³

working load limit	diameter	length inside	width inside	weight each
t	a mm	b mm	c mm	kg
4.1	16	150	75	0.72
5.8	22	270	140	2.3
8.83	26	270	140	3.3
14.5	28	200	110	3
14.5	28	270	140	3.8
17.1	32	270	140	5.1
23.0	36	270	140	6.5
28.1	40	280	155	8.5
38.3	45	320	175	12.2
45	50	350	195	16.6
75	65	410	220	33.2
100	75	450	250	49.3

In inch

working load limit	diameter	length inside	width inside	weight each
t	a inch	b inch	c inch	lbs
4.1	$\frac{5}{8}$	$5 \frac{29}{32}$	$2 \frac{15}{16}$	1.59
5.8	$\frac{7}{8}$	$10 \frac{5}{8}$	$5 \frac{1}{2}$	5.07
8.83	$1 \frac{1}{32}$	$10 \frac{5}{8}$	$5 \frac{1}{2}$	7.28
14.5	$1 \frac{3}{32}$	$7 \frac{7}{8}$	$4 \frac{1}{2}$	6.61
14.5	$1 \frac{3}{32}$	$10 \frac{5}{8}$	$5 \frac{16}{32}$	8.38
17.1	$1 \frac{1}{4}$	$10 \frac{5}{8}$	$5 \frac{1}{2}$	11.24
23.0	$1 \frac{13}{32}$	$10 \frac{5}{8}$	$5 \frac{1}{2}$	14.33
28.1	$1 \frac{9}{16}$	$11 \frac{1}{32}$	$6 \frac{3}{32}$	18.74
38.3	$1 \frac{25}{32}$	$12 \frac{19}{32}$	$6 \frac{7}{8}$	26.9
45	$1 \frac{31}{32}$	$13 \frac{25}{32}$	$7 \frac{11}{16}$	36.6
75	$2 \frac{1}{2}$	$16 \frac{5}{32}$	$8 \frac{21}{32}$	73.19
100	$2 \frac{15}{16}$	$17 \frac{23}{32}$	$9 \frac{27}{32}$	108.69



C

DNV GL Master Link Assembly

- **Material:** alloy steel, grade 8
- **Safety Factor:** MBL equals 5 x WLL
- **Standard:** DNV 2.7-1, EN 12079-2 and EN 1677-4
- **Finish:** painted orange
- **Temperature range:** -20°C up to +200°C
- **Certification:** 2.1 2.2 3.1 MTC^b DNV GL 2.7-1^a

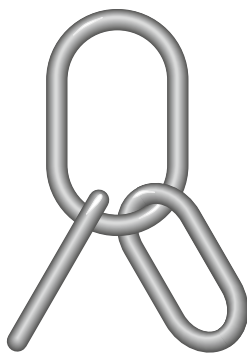

P-6820

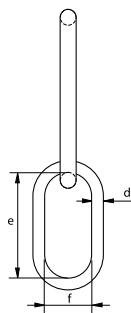
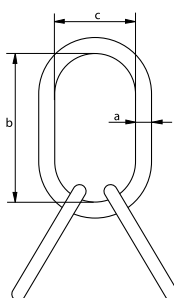

working load limit	diameter	length inside	width inside	diameter	length inside	width inside	weight each
t	a mm	b mm	c mm	d mm	e mm	f mm	kg
4.1	16	150	75	14.5	125	60	1.3
5.8	22	270	140	16	150	75	3.8
8.83	26	270	140	20	140	70	5.3
11.8	28	270	140	20	140	70	5.9
17.1	32	270	140	26	190	102	9.7
23	36	270	140	28	190	100	11.9
28.1	40	280	155	32	270	140	18.6
38.3	45	320	175	36	270	140	25.4
45	50	350	195	40	260	130	32.3
65	60	410	220	50	350	195	62
100	75	450	250	65	410	220	116

In inch

working load limit	diameter	length inside	width inside	diameter	length inside	width inside	weight each
t	a inch	b inch	c inch	d inch	e inch	f inch	lbs
4.1	$\frac{5}{8}$	$5 \frac{29}{32}$	$2 \frac{15}{16}$	$\frac{9}{16}$	$4 \frac{29}{32}$	$2 \frac{3}{8}$	2.87
5.8	$\frac{7}{8}$	$10 \frac{5}{8}$	$5 \frac{1}{2}$	$\frac{3}{4}$	$5 \frac{29}{32}$	$2 \frac{15}{16}$	8.38
8.83	$1 \frac{1}{32}$	$10 \frac{5}{8}$	$5 \frac{1}{2}$	$\frac{25}{32}$	$5 \frac{1}{2}$	$2 \frac{3}{4}$	11.68
11.8	$1 \frac{3}{32}$	$10 \frac{5}{8}$	$5 \frac{1}{2}$	$\frac{25}{32}$	$5 \frac{1}{2}$	$2 \frac{3}{4}$	13.01
17.1	$1 \frac{1}{4}$	$10 \frac{5}{8}$	$5 \frac{1}{2}$	$1 \frac{1}{32}$	$7 \frac{15}{32}$	$4 \frac{1}{32}$	21.39
23	$1 \frac{13}{32}$	$10 \frac{5}{8}$	$5 \frac{1}{2}$	$1 \frac{3}{32}$	$7 \frac{15}{32}$	$3 \frac{15}{16}$	26.24
28.1	$1 \frac{9}{16}$	$11 \frac{1}{32}$	$6 \frac{3}{32}$	$1 \frac{1}{4}$	$10 \frac{5}{8}$	$5 \frac{1}{2}$	41.01
38.3	$1 \frac{25}{32}$	$12 \frac{19}{32}$	$6 \frac{7}{8}$	$1 \frac{13}{32}$	$10 \frac{5}{8}$	$5 \frac{1}{2}$	55.99
45	$1 \frac{31}{32}$	$13 \frac{25}{32}$	$7 \frac{11}{16}$	$1 \frac{9}{16}$	$10 \frac{1}{4}$	$5 \frac{1}{8}$	71.21
65	$2 \frac{3}{8}$	$16 \frac{5}{32}$	$8 \frac{21}{32}$	$1 \frac{31}{32}$	$13 \frac{25}{32}$	$7 \frac{11}{16}$	136.69
100	$2 \frac{15}{16}$	$17 \frac{23}{32}$	$9 \frac{27}{32}$	$2 \frac{1}{2}$	$16 \frac{5}{32}$	$8 \frac{21}{32}$	255.74



SWIVELS



Applications

Thrust bearing swivels are used to prevent wire rope or chain from transferring their normal twisting motion to the item being lifted. Green Pin® swivels without bearings are not designed to rotate under load, but are intended as positioning devices only. For rotation under load, thrust bearing swivels or needle bearing swivels should be used. Our swivels can be supplied with two types of end fittings.

Range

Green Pin® offers four types of swivels:

- Grade 8 needle bearing swivels (eye-eye/clevis-clevis), ranging from WLL 1.12 up to 12.8 tons;
- Grade 10 needle bearing swivel (eye-eye) ranging from WLL 1.4 up to 16 tons;
- Swivels (eye-eye/jaw-eye), ranging from WLL 0.39 up to 20.5 tons;
- Thrust bearing swivels (eye-eye), ranging from WLL 1 up to 40 tons.

Van Beest offers a wide range of other swivels to complement the Green Pin® assortment.

Design

Green Pin® swivels are drop forged. Thrust bearing swivels are machined from carbon steel. The range of thrust bearing swivels we supply are fitted with grease nipples to ensure long life and smooth operation. The greasing schedule must be adjusted to the frequency and intensity of use. The needle bearing swivels do not require greasing during use.

Each swivel is generally marked with:

- Working Load Limit - e.g. 2.4 t
- manufacturer's symbol - e.g. GP
- size in mm and/or inch - e.g. 13 and/or 1/2" or 5/8"
- traceability code - e.g. HA
- steel grade (specific products) - 8 or 10
- item code (specific products) - e.g. ELR
- origin (specific products) - e.g. France

Finish

Green Pin® thrust- and needle bearing swivels are painted. Eye-eye and jaw-eye swivels are hot dipped galvanized. Grade 8 products were painted yellow or red under the Excel® brand. However, grade 8 swivels under the Green Pin® brand will be painted white. Grade 10 products are painted blue and will remain so.

Certification

Specific details of certificate availability can be found on each product page. Please verify your certification requirements at the time of order.

Instructions for use

Swivels should be inspected before use to ensure that:

- all markings are legible;
- a swivel with the correct WLL has been selected;
- the bolt, nut or any other locking system cannot vibrate out of position;
- swivels are free from nicks, gouges and cracks;
- swivels and the other components are all of the same steel grade;
- swivels are not distorted or unduly worn.

Also:

- swivels must be used for in-line lifting only;
- swivels may not be heat treated as this may affect their WLL;
- never modify, repair or reshape a swivel by machining, welding, heating or bending as this may affect the WLL.

The WLL should be applied in-line. Avoid overloads. Side loading is not allowed since the swivels are not designed for this purpose. Never replace a swivel pin or nut with a pin other than the one designed for the purpose, as otherwise the swivel may not be suitable for the load imposed. Swivels must be regularly inspected in accordance with the safety standards given in the country of use. This is required because the products in use may be affected by issues such as wear, misuse and overloading, which may lead to deformation and alteration of the material structure. Inspection should take place at least every six months and more frequently when the swivels are used in severe operating conditions.

Assembly

Swivels with a clevis can be connected directly to a lifting chain. Swivels with an eye-fitting must be connected to lifting chain through a connector such as a connecting link.



Green Pin® EE Swivel

Swivel with eye-eye end-fitting

- **Material:** high tensile steel, quenched and tempered
- **Safety factor:** MBL equals 5 x WLL
- **Standard:** US Federal Spec. RR-C-271, Type VII, Class 2
- **Finish:** hot dipped galvanized
- **Certification:** 2.1 2.2



G-7713

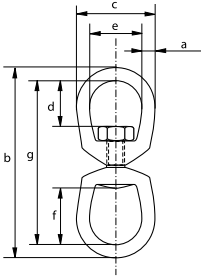

working load limit	diameter	length outside	width outside	length inside	width inside	length inside	length	weight each
t	a mm	b mm	c mm	d mm	e mm	f mm	g mm	kg
0.39	6	87	32	18	19	27	75	0.1
0.57	8	106	41	21	25	32	90	0.18
1.02	10	129	51	24	32	38	109	0.3
1.6	13	164	64	33	38	51	138	0.6
2.4	16	199	76	40	44	60	167	1
3.3	19	221	89	44	51	67	183	1.82
4.5	22	257	102	52	57	78	213	2.55
5.7	25	295	114	59	64	89	245	4.06
8.2	32	337	143	68	80	94	273	7.43
20.5	38	501	178	102	102	150	425	20.8



Green Pin® JE Swivel CP

Swivel with jaw-eye end-fitting and cotter pin

- **Material:** high tensile steel, quenched and tempered
- **Safety factor:** MBL equals 5 x WLL
- **Standard:** US Federal Spec. RR-C-271, Type VII, Class 3
- **Finish:** hot dipped galvanized
- **Certification:** 2.1 2.2



G-7723

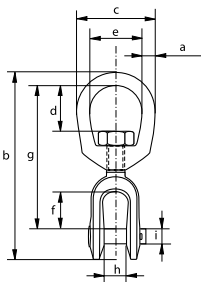

working load limit	diameter	length	width outside	length inside	width inside	length inside	length	width inside	diameter pin	weight each
t	a mm	b mm	c mm	d mm	e mm	f mm	g mm	h mm	i mm	kg
0.39	6	84	32	18	19	22	67	12	6	0.09
0.57	8	98	41	21	25	22	75	13	8	0.16
1.02	10	121	51	24	32	27	92	16	10	0.32
1.6	13	154	64	33	38	33	114	19	13	0.57
2.4	16	186	76	40	44	38	135	24	16	1.12
3.3	19	211	89	44	51	44	154	29	19	1.76
4.5	22	242	102	52	57	52	178	30	22	2.66
5.7	25	290	114	59	64	71	217	44	29	4.02
8.2	32	329	143	68	80	71	230	52	35	7.14
20.5	38	501	178	106	102	113	364	73	50	24.8

Green Pin® Thrust Bearing EE Swivel

Swivel with eye-eye end-fitting and thrust bearings

- **Material:** carbon steel
- **Safety factor:** MBL equals 5 x WLL
- **Finish:** painted black
- **Certification:** 2.1 2.2 MTC^a



P-7740

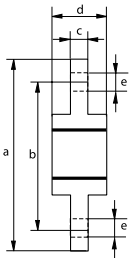

working load limit	length	length	thickness	diameter	diameter hole	weight each
t	a mm	b mm	c mm	d mm	e mm	kg
1	174	128	12.5	49	21	1.4
2	223	173	19	68	22	3.5
3	278	210	26	79	29	6.4
5	290	222	26	89	31	7.9
8	366	276	40	106	43	15.2
10	390	300	40	118	49	19.1
15	457	355	40	128	49	26.6
20	474	372	40	118	51	25
30	612	472	64	138	59	50
40	760	600	68	168	65	-



Green Pin® Needle Bearing Swivel EE GR8

Grade 8 needle bearing eye-eye swivel



ELR

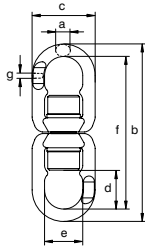

- **Material:** alloy steel, grade 8, quenched and tempered
- **Safety factor:** MBL equals 4 x WLL
- **Finish:** painted red (R) or white
- **Temperature range:** -40°C up to +200°C
- **Certification:** 2.1 2.2 3.1 MTC^b
- **Note:** equipped with two needle roller thrust bearings to enable rotation under load

for chain diameter		working load limit	diameter		length outside		width outside		length inside		width inside		length	thickness	weight each
mm	inch		t	a mm	b mm	c mm	d mm	e mm	f mm	g mm	kg				
5-6	$\frac{3}{16} - \frac{7}{32}$	1.12	11	150	56	33	32	126	6	0.61					
7-8	$\frac{1}{4} - \frac{5}{16}$	2	14	181	65	40	37	153	8	1.07					
10	$\frac{3}{8}$	3.2	18	226	79	47	48	195	11	1.9					
13	$\frac{1}{2}$	5.4	20	268	96	59	58	227	14	3.17					
16	$\frac{5}{8}$	8.2	23	331	121	67	73	281	17	6.44					
18-20	$\frac{3}{4}$	12.8	28	378	132	88	82	328	22	7.75					



Green Pin® Needle Bearing Swivel EE GR10

Grade 10 needle bearing eye-eye swivel



UELR

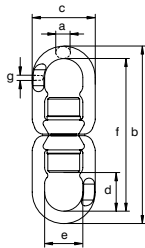

- **Material:** alloy steel, grade 10, quenched and tempered
- **Safety factor:** MBL equals 4 x WLL
- **Finish:** painted blue
- **Temperature range:** -40°C up to +200°C
- **Certification:** 2.1 2.2 3.1 MPI^b
- **Note:** equipped with two needle roller thrust bearings to enable rotation under load

for chain diameter		working load limit	diameter		length outside		width outside		length inside		width inside		length	thickness	weight each
mm	inch		t	a mm	b mm	c mm	d mm	e mm	f mm	g mm	kg				
6	$\frac{7}{32}$	1.4	11	150	56	33	32	126	6	0.61					
8	$\frac{9}{32} - \frac{5}{16}$	2.6	14	181	65	40	37	153	8	1.07					
10	$\frac{3}{8}$	4	18	226	79	47	48	195	11	1.9					
13	$\frac{1}{2}$	6.8	20	268	96	59	58	227	14	3.17					
16	$\frac{5}{8}$	10.3	23	331	121	67	73	281	17	6.44					
20	$\frac{3}{4}$	16	28	378	132	88	82	328	22	7.75					

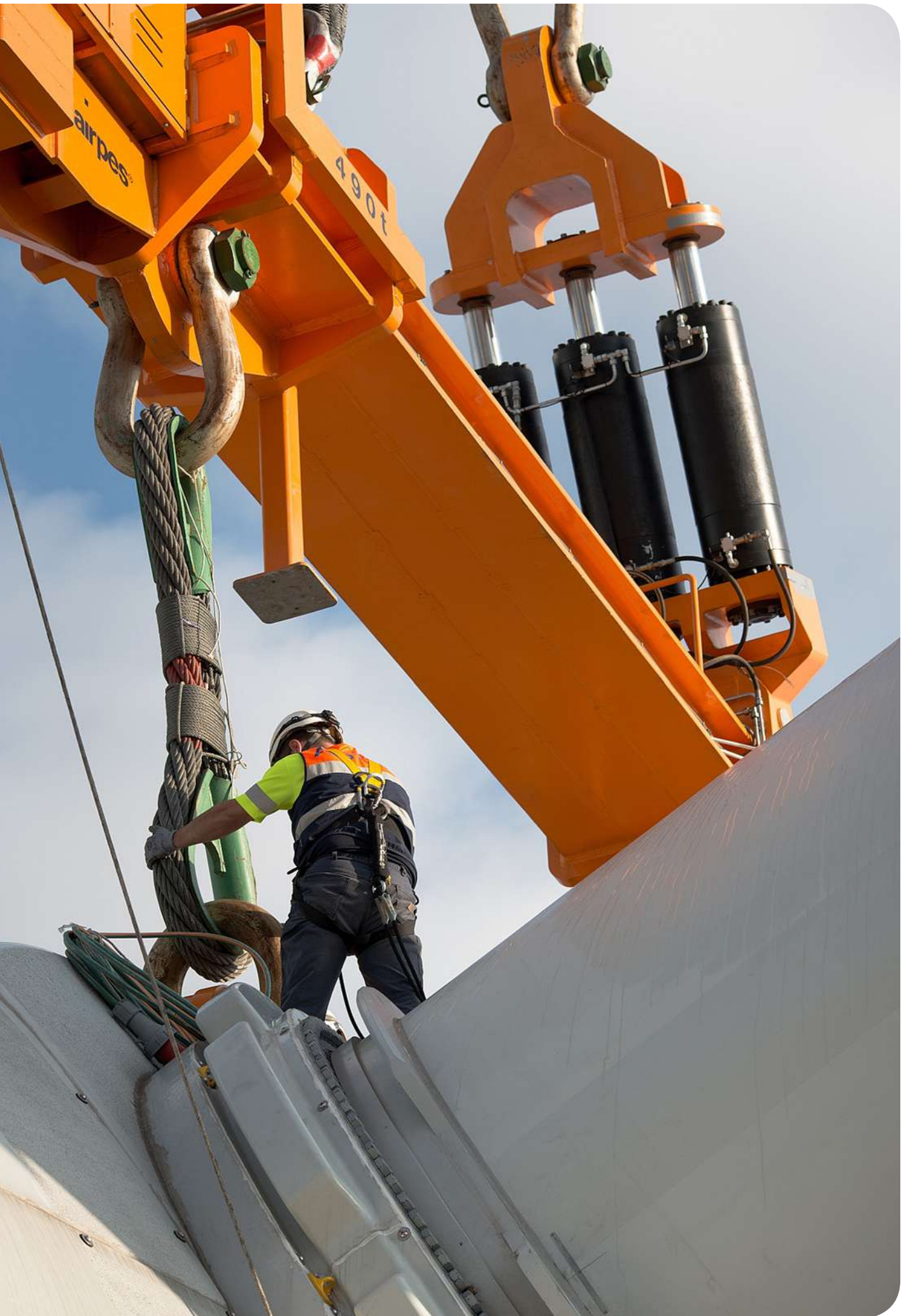

HOOKS



Applications

Hooks are used in lifting systems as a connection between the load to be lifted and the wire rope or chain slings. Grade 8 chain components are designed to be used in the assembly of grade 8 chain slings. Grade 10 chain components are designed to be used in the assembly of grade 10 chain slings. Lashing hooks are suitable for many different lashing purposes, but may never be used for lifting.

Range

Green Pin® offers a range of hooks, from drop-forged carbon steel eye hooks to drop forged alloy steel swivel hooks, which are quenched and tempered. Grade 8 chain components enable the assembly of a complete sling from the top master link to the hooks. The range extends from 5 mm to 32 mm ($\frac{3}{16}$ " to $1\frac{1}{4}$ "). The range of grade 10 hooks extends from 6 mm to 20 mm ($\frac{7}{32}$ " to $\frac{3}{4}$ "). Van Beest offers a wide range of other hooks to complement the Green Pin® assortment.

Design

There are different types of hooks with specific designs to suit various purposes. Eye hooks and swivel hooks are designed to be used with wire rope or chain. Pipe line hooks are designed for easy handling of tubes. Most types of hooks are supplied with a safety latch. Green Pin Tycan® hooks are designed to be used with Green Pin Tycan® Chain.

All types of hooks are generally marked with:

- Working Load Limit - e.g. 5.4 t
- manufacturer's symbol - e.g. GP
- traceability code - e.g. H-AB or HA
- steel grade - e.g. 4, 8 or 10
- size in mm and/or inch - e.g. 13 and/or $\frac{1}{2}$ "
- steel grade - e.g. 8
- item code (specific products) - e.g. CSO
- origin (specific products) - e.g. France

Lashing hooks are designed to be used for cargo lashing during transportation. Lashing should be done in accordance with relevant safety rules.

Finish

Green Pin® hooks are painted. Grade 8 products were painted yellow or red under the Excel® brand. However, grade 8 hooks under the Green Pin® brand will be painted white. Grade 10 products are painted blue and will remain so.

Certification

Specific details of certificate availability can be found on each product page. Please verify your certification requirements at the time of order.

Instructions for use

Lifting hooks should be inspected before use to ensure that:

- all markings are legible;
- a hook with the correct WLL has been selected. Refer to the EN 818 standard for Chain Slings for further details;
- the latch is present;
- the latch is functional;
- the bolt, nut or any other locking system cannot vibrate out of position;
- the hook is never side-, tip- or back- loaded;
- swivel hooks may not rotate under load;
- the hook is supporting the load correctly;
- the latch should not be supporting any load;
- the hooks are free from nicks, gouges and cracks;
- items are not distorted or unduly worn.

Also:

- the hooks may not be heat treated as this may affect their WLL;
- never modify, repair or reshape a hook by machining, welding, heating or bending as this may affect the WLL;
- all components of the sling must be of the same steel grade;
- items should be used for in-line lifting only.

Lashing hooks should be inspected before use to ensure that:

- all markings are legible;
- items are not distorted or unduly worn;
- hooks are free from nicks, gouges and cracks;

Also:

- never use the items used for lifting;
- use the items for in-line loading only;
- never modify, repair or reshape a hook by machining, welding, heating or bending as this may affect the lashing capacity.

Hooks must be regularly inspected in accordance with the safety standards given in the country of use. This is required because the products in use may be affected by issues such as wear, misuse, and overloading which may lead to deformation and alteration of the material structure. Inspection should take place at least every six months and more frequently when the hooks are used in severe operating conditions.



Green Pin® Hook E GR4

Grade 4 large eye hook with safety latch



P-6714C

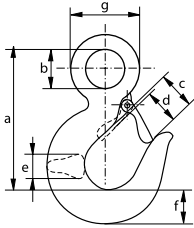

- **Material:** carbon steel, grade 4
- **Safety factor:** MBL equals 5 x WLL
- **Standard:** generally to EN 1677-5
- **Finish:** painted green
- **Certification:** 2.1 2.2 3.1

working load limit	length	diameter eye inside	opening hook	opening hook	thickness	width	diameter eye outside	weight each
t	a mm	b mm	c mm	d mm	e mm	f mm	g mm	kg
0.8	81	19	24	20	16	19	37	0.27
1	91	22	26	22	18	22	45	0.4
1.6	105	27	32	27	20	27	52	0.64
2	124	32	34	30	24	31	62	1.08
3.2	147	39	44	37	31	36	74	1.68
5	190	50	55	48	37	48	96	3.75

In inch

working load limit	length	diameter eye inside	opening hook	opening hook	thickness	width	diameter eye outside	weight each
t	a inch	b inch	c inch	d inch	e inch	f inch	g inch	lbs
0.8	3 ³ / ₁₆	³ / ₄	¹⁵ / ₁₆	²⁵ / ₃₂	⁵ / ₈	³ / ₄	1 ¹ / ₂	0.6
1	3 ¹⁹ / ₃₂	⁷ / ₈	1 ¹ / ₃₂	⁷ / ₈	²³ / ₃₂	⁷ / ₈	1 ²⁵ / ₃₂	0.88
1.6	4 ¹ / ₈	1 ³ / ₃₂	1 ⁹ / ₃₂	1 ³ / ₃₂	²⁵ / ₃₂	1 ³ / ₃₂	2 ¹ / ₃₂	1.32
2	4 ⁷ / ₈	1 ⁹ / ₃₂	1 ¹¹ / ₃₂	1 ³ / ₁₆	¹⁵ / ₁₆	1 ¹ / ₄	2 ⁷ / ₁₆	2.16
3.2	5 ²⁵ / ₃₂	1 ⁹ / ₁₆	1 ³ / ₄	1 ¹ / ₂	1 ¹ / ₄	1 ⁷ / ₁₆	2 ²⁹ / ₃₂	3.7
5	7 ¹ / ₂	1 ³¹ / ₃₂	2 ⁵ / ₃₂	1 ²⁹ / ₃₂	1 ¹ / ₂	1 ²⁹ / ₃₂	3 ²⁵ / ₃₂	7.94

Green Pin® Hook E GR8

Grade 8 large eye hook with safety latch



P-6714A

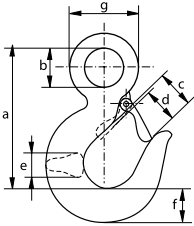

- **Material:** alloy steel, grade 8
- **Safety factor:** MBL equals 4 x WLL
- **Standard:** generally to EN 1677-2
- **Finish:** painted red
- **Certification:** 2.1 2.2 3.1

working load limit	length	diameter eye inside	opening hook	opening hook	thickness	width	diameter eye outside	weight each
t	a mm	b mm	c mm	d mm	e mm	f mm	g mm	kg
1.25	81	19	24	20	16	19	37	0.3
1.6	91	22	26	22	18	22	45	0.44
2.5	105	27	32	27	20	27	52	0.63
3.2	124	32	34	30	24	31	62	1.27
5.4	147	39	44	37	31	36	74	1.76
8.2	190	50	55	48	37	48	96	3.6
12.8	230	64	64	53	48	61	126	7.7
16	254	70	70	60	58	69	139	10.8
22	316	89	91	77	63	81	169	16.7

In inch

working load limit	length	diameter eye inside	opening hook	opening hook	thickness	width	diameter eye outside	weight each
t	inch	inch	inch	inch	inch	inch	inch	lbs
1.25	3 ³ / ₁₆	³ / ₄	¹⁵ / ₁₆	²⁵ / ₃₂	⁵ / ₈	³ / ₄	1 ¹ / ₂	0.66
1.6	3 ¹⁹ / ₃₂	⁷ / ₈	1 ¹ / ₃₂	⁷ / ₈	²³ / ₃₂	⁷ / ₈	1 ²⁵ / ₃₂	0.97
2.5	4 ¹ / ₈	1 ³ / ₃₂	1 ⁹ / ₃₂	1 ³ / ₃₂	²⁵ / ₃₂	1 ³ / ₃₂	2 ¹ / ₃₂	1.39
3.2	4 ⁷ / ₈	1 ⁹ / ₃₂	1 ¹¹ / ₃₂	1 ³ / ₁₆	¹⁵ / ₁₆	1 ¹ / ₄	2 ⁷ / ₁₆	2.80
5.4	5 ²⁵ / ₃₂	1 ⁹ / ₁₆	1 ³ / ₄	1 ¹ / ₂	1 ¹ / ₄	1 ⁷ / ₁₆	2 ²⁹ / ₃₂	3.88
8.2	7 ¹ / ₂	1 ³¹ / ₃₂	2 ⁵ / ₃₂	1 ²⁹ / ₃₂	1 ¹ / ₂	1 ²⁹ / ₃₂	3 ²⁵ / ₃₂	7.94
12.8	9 ³ / ₃₂	2 ¹⁷ / ₃₂	2 ¹⁷ / ₃₂	2 ³ / ₃₂	1 ²⁹ / ₃₂	2 ³ / ₈	4 ¹⁵ / ₁₆	16.98
16	10	2 ³ / ₄	2 ³ / ₄	2 ¹¹ / ₃₂	2 ⁹ / ₃₂	2 ²³ / ₃₂	5 ¹ / ₂	23.8
22	12 ⁷ / ₁₆	3 ¹⁷ / ₃₂	3 ¹⁹ / ₃₂	3 ¹ / ₃₂	2 ¹ / ₂	3 ³ / ₁₆	6 ⁵ / ₈	36.8



Green Pin® Hook SE GR8

Grade 8 swivel eye hook with safety latch

- **Material:** alloy steel, grade 8
- **Safety factor:** MBL equals 4 x WLL
- **Finish:** painted red
- **Certification:** 2.1 2.2 3.1

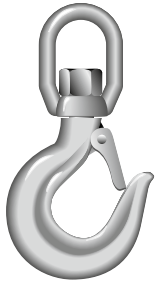

P-6703A

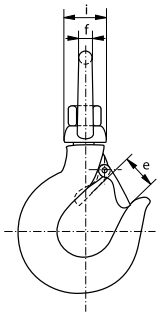
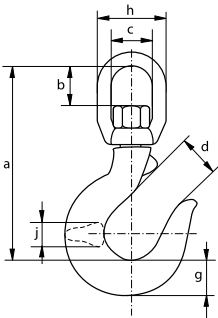

working load limit	length	length inside	width inside	opening hook	opening hook	diameter	width	width	width	thickness	weight each
t	a mm	b mm	c mm	d mm	e mm	f mm	g mm	h mm	i mm	j mm	kg
1.25	118	28	31	24	20	11	19	52	30	16	0.49
1.6	145	35	40	26	22	14	23	68	37	18	0.95
2.5	167	43	47	32	27	17	27	81	43	20	1.48
3.2	180	47	47	34	30	17	31	81	43	24	1.79
5.4	217	54	64	44	37	21	37	106	64	31	3.8
8.2	276	69	78	55	48	26	48	130	77	37	7.4
11.5	310	68	82	58	53	22	60	136	82	43	9.7
16	352	84	92	66	58	24	67	154	92	52	14.9
22	434	107	115	87	78	29	80	191	108	64	27
31.5	512	117	132	97	87	34	94	222	132	80	46

In inch

working load limit	length	length inside	width inside	opening hook	opening hook	diameter	width	width	width	thickness	weight each
t	a inch	b inch	c inch	d inch	e inch	f inch	g inch	h inch	i inch	j inch	lbs
1.25	4 5/8	1 1/8	1 1/4	15/16	25/32	7/16	3/4	2 1/32	1 3/16	5/8	1.08
1.6	5 23/32	1 3/8	1 19/32	1 1/32	7/8	9/16	29/32	2 11/16	1 1/2	23/32	2.09
2.5	6 9/16	1 23/32	1 7/8	1 9/32	1 3/32	11/16	1 3/32	3 3/16	1 23/32	25/32	3.26
3.2	7 3/32	1 7/8	1 7/8	1 11/32	1 3/16	11/16	1 1/4	3 3/16	1 23/32	15/16	3.95
5.4	8 9/16	2 1/8	2 17/32	1 3/4	1 1/2	13/16	1 1/2	4 5/32	2 17/32	1 1/4	8.38
8.2	10 7/8	2 23/32	3 3/32	2 5/32	1 15/16	1 1/32	1 29/32	5 1/8	3 1/32	1 1/2	16.31
11.5	12 3/16	2 11/16	3 1/4	2 9/32	2 3/32	7/8	2 11/32	5 11/32	3 1/4	1 23/32	21.38
16	13 7/8	3 5/16	3 5/8	2 19/32	2 9/32	15/16	2 5/8	6 1/32	3 5/8	2 1/32	32.8
22	17 1/8	4 3/16	4 17/32	3 7/16	3 3/32	1 5/32	3 5/32	7 17/32	4 1/4	2 17/32	59.5
31.5	20 5/32	4 19/32	5 3/16	3 13/16	3 7/16	1 11/32	3 23/32	8 3/4	5 3/16	3 5/32	101.4



Green Pin® Pipe Line Hook

Hook for handling cylindrical objects (pipes, tubes)

- **Material:** alloy steel
- **Safety factor:** MBL equals 5 x WLL
- **Finish:** painted red
- **Certification:** 2.1 2.2 3.1



P-6731

working load limit at hook		length	diameter eye inside	opening hook	diameter	thickness	diameter eye outside	width	weight each
top t	bottom t	a mm	b mm	c mm	d mm	e mm	f mm	g mm	kg
2	7.5	167	35	74	30	31	73	57	2.65

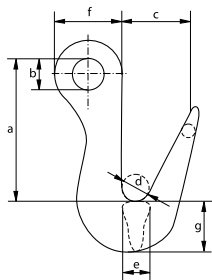

Green Pin® Alloy Sliding Choker Hook

Grade 8 sliding choker hook with safety latch

- **Material:** alloy steel, grade 8
- **Safety factor:** MBL equals 5 x WLL
- **Finish:** painted red
- **Certification:** 2.1 2.2 3.1

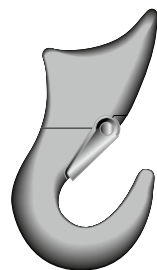

P-6706A

working load limit	diameter rope	length	width	thickness	length	diameter	thickness	opening hook	weight each
t	mm	a mm	b mm	c mm	d mm	e mm	f mm	g mm	kg
0.8	6 - 11	112	63	19	65	14	30	16	0.4
1.6	10 - 13	143	82	26	83	17	30	19	0.8
2.5	14 - 16	170	98	30	97	19	33	25	1.2
3.2	16 - 20	196	115	36	110	22	40	28	1.9
5.4	22 - 26	260	142	46	145	36	60	35	4.2

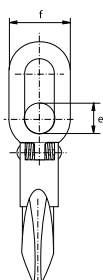
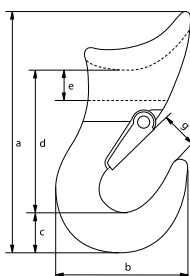



Green Pin® Sling Hook E EN 1677-2 GR8

Grade 8 eye sling hook EN 1677-2



CSO

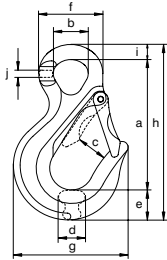

- **Material:** alloy steel, grade 8, quenched and tempered
- **Safety factor:** MBL equals 4 x WLL
- **Standard :** EN 1677-2
- **Finish:** painted yellow (J), red (R) or white
- **Temperature range:** -40°C up to +200°C
- **Certification:** 2.1 2.2 3.1 * MPI^b * DGUV *
- **Note:** from 8.2 t without flat part

for chain diameter		working load limit	length	diameter		width opening	thickness	width	diameter		length outside	width	thickness	weight each
mm	inch			inside eye	outside				eye outside	outside				
5-6	3/16 - 7/32	1.12	a	b	c	d	e	f	g	h	i	j		kg
7 - 8	1/4 - 5/16	2	84	23	26	15	20	43	72	114	10	6	0.28	
10	3/8	3.2	103	26	30	20	24	51	87	139	12	8	0.56	
13	1/2	5.4	128	35	33	24	29	65	106	172	15	10	1.09	
16	5/8	8.2	152	41	37	32	39	77	133	209	18	12	1.98	
18 - 20	3/4	12.8	190	52	44	40	44	94	165	255	21	16	3.55	
22	7/8	15.5	237	60	61	49	62	115	208	327	28	21	7.1	
26	1	21.6	280	72	75	54	65	132	242	375	30	23	9.9	
32	1 1/4	32.8	259	70	73	70	75	144	235	371	37	37	13.3	
			299	66	87	78	89	150	281	430	42	42	21.6	

* Excluding sizes 26 mm and 32 mm



Green Pin® Sling Hook CL EN 1677-2 GR8

Grade 8 clevis sling hook EN 1677-2



CSC

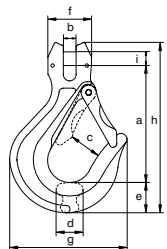

- **Material:** alloy steel, grade 8, quenched and tempered
- **Safety factor:** MBL equals 4 x WLL
- **Standard :** EN 1677-2
- **Finish:** painted yellow (J), red (R) or white
- **Temperature range:** -40°C up to +200°C
- **Certification:** 2.1 2.2 3.1 MPI^b DGUV

for chain diameter		working load limit	length	width	width opening	thickness	width	width		length outside	diameter pin	weight each
mm	inch							outside	outside			
5	3/16	0.8	a	b	c	d	e	f	g	h	i	kg
6	7/32	1.12	76	7	26	15	20	28	72	108	6	0.29
7 - 8	1/4 - 5/16	2	75	7	26	15	20	28	72	108	8	0.29
10	3/8	3.2	95	9	30	20	24	32	87	136	9	0.58
13	1/2	5.4	113	12	33	24	29	42	106	164	13	1.1
16	5/8	8.2	138	15	37	32	39	54	133	208	16	2.12
18 - 20	3/4	12.8	161	19	44	40	44	68	165	240	20	3.67
22	7/8	15.5	198	23	61	49	62	82	208	305	24	7.32
			236	25	75	54	65	97	242	350	28	10.63



Green Pin® Sling Hook SE EN 1677-2 GR8

Grade 8 swivel sling hook EN 1677-2

- **Material:** alloy steel, grade 8, quenched and tempered
- **Safety factor:** MBL equals 4 x WLL
- **Standard :** EN 1677-2
- **Finish:** painted yellow (J), red (R) or white
- **Temperature range:** -40°C up to +200°C
- **Certification:** 2.1 2.2 3.1 MPI[®] DGUV
- **Note:** equipped with needle roller thrust bearing to enable rotation under load



CSE

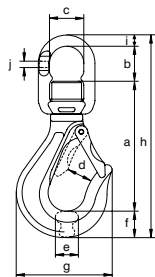

for chain diameter		working load limit	length	length inside	width inside	width opening	thickness	width	width outside	length outside	diameter	thickness	weight each
mm	inch												
5 - 6	3/16 - 7/32	1.12	100	33	32	26	15	20	72	164	12	6	0.55
7 - 8	1/4 - 5/16	2	126	39	37	30	20	24	87	200	14	8	1
10	3/8	3.2	159	47	48	33	24	29	106	250	16	11	1.9
13	1/2	5.4	189	59	58	37	32	39	133	307	21	14	3.39
16	5/8	8.2	216	68	73	44	40	44	165	352	25	17	6.25
18 - 20	3/4	12.8	263	87	82	61	49	62	208	437	25	22	10.5



Green Pin® Sling Hook SCL EN 1677-2 GR8

Grade 8 swivel sling hook with clevis EN 1677-2

- **Material:** alloy steel, grade 8, quenched and tempered
- **Safety factor:** MBL equals 4 x WLL
- **Standard :** EN 1677-2
- **Finish:** painted yellow (J), red (R) or white
- **Temperature range:** -40°C up to +200°C
- **Certification:** 2.1 2.2 3.1 MPI[®] DGUV
- **Note:** equipped with needle roller thrust bearing to enable rotation under load



CSECA

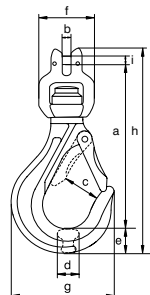

for chain diameter		working load limit	length	width	width opening	thickness	width	width outside	width outside	length	diameter pin	weight each
mm	inch											
5	3/16	0.8	126	7	26	15	20	56	72	159	6	0.56
6	7/32	1.12	125	7	26	15	20	56	72	159	8	0.56
7/8	1/4 - 5/16	2	153	9	30	20	24	65	87	194	9	0.99
10	3/8	3.2	188	12	33	24	29	79	106	240	13	1.95
13	1/2	5.4	224	15	37	32	39	96	133	294	16	3.54
16	5/8	8.2	270	19	44	40	44	121	165	350	20	6.61



Green Pin® Self Locking Hook E EN 1677-3 GR8

Grade 8 eye self locking hook EN 1677-3

- **Material:** alloy steel, grade 8, quenched and tempered
- **Safety factor:** MBL equals 4 x WLL
- **Standard :** EN 1677-3
- **Finish:** painted yellow (J), red (R) or white
- **Temperature range:** -40°C up to +200°C
- **Certification:** 2.1 2.2 3.1 MPI[®] DGUV
- **Note:** from 12.8 t without flat part



XLO

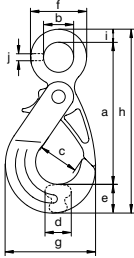

for chain diameter		working load limit	length	diameter		width opening	thickness	width	width outside	width outside	length	width	thickness	weight each
mm	inch			a mm	b mm									
5 - 6	$\frac{3}{16}$ - $\frac{7}{32}$	1.12	111	24	32	16	26	47	77	147	11	7	0.51	
7 - 8	$\frac{1}{4}$ - $\frac{5}{16}$	2	134	29	43	23	29	57	92	176	14	7	0.91	
10	$\frac{3}{8}$	3.2	168	35	47	32	35	69	111	219	17	10	1.79	
13	$\frac{1}{2}$	5.4	199	46	61	37	45	87	142	264	20	13	3.36	
16	$\frac{5}{8}$	8.2	247	59	74	43	56	111	185	328	26	16	7	
18 - 20	$\frac{3}{4}$	12.8	282	69	88	51	63	126	207	374	28	20	9.22	



Green Pin® Self Locking Hook EN 1677-3 CL GR8

Grade 8 clevis self locking hook EN 1677-3

- **Material:** alloy steel, grade 8, quenched and tempered
- **Safety factor:** MBL equals 4 x WLL
- **Standard :** EN 1677-3
- **Finish:** painted yellow (J), red (R) or white
- **Temperature range:** -40°C up to +200°C
- **Certification:** 2.1 2.2 3.1 MPI[®] DGUV



XLC

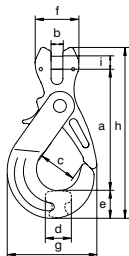

for chain diameter		working load limit	length	width	width opening	thickness	width	width outside	width outside	length	diameter pin	weight each
mm	inch											
5	$\frac{3}{16}$	0.8	92	7	32	16	26	28	77	131	6	0.49
6	$\frac{7}{32}$	1.12	92	7	32	16	26	28	77	131	8	0.49
7-8	$\frac{1}{4}$ - $\frac{5}{16}$	2	116	9	43	23	29	32	92	161	9	0.91
10	$\frac{3}{8}$	3.2	143	12	47	32	35	42	111	200	13	1.77
13	$\frac{1}{2}$	5.4	167	15	61	37	45	54	142	242	16	3.33
16	$\frac{5}{8}$	8.2	201	19	74	43	56	68	185	293	20	6.75
18 - 20	$\frac{3}{4}$	12.8	232	23	88	51	63	82	207	341	24	9.57



Green Pin® Self Locking Hook E GR8

Grade 8 eye self locking hook

- **Material:** alloy steel, grade 8, quenched and tempered
- **Safety factor:** MBL equals 4 x WLL
- **Finish:** painted yellow (J), red (R) or white
- **Temperature range:** -40°C up to +200°C
- **Certification:** 2.1 2.2 MPI³



GKO

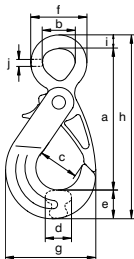

for chain diameter		working load limit	length	diameter inside eye	width opening	thickness	width	width outside	width outside	length	width	thickness	weight each
mm	inch												
7 - 8	$\frac{1}{4} - \frac{5}{16}$	2	113	24	32	17	25	48	77	151	13	9	0.53
10	$\frac{3}{8}$	3.2	134	30	43	24	29	59	92	180	17	10	0.94
13	$\frac{1}{2}$	5.4	170	39	47	32	34	75	111	225	20	12	1.86
16	$\frac{5}{8}$	8.2	207	49	61	37	46	93	142	273	22	15	3.49
18 - 20	$\frac{3}{4}$	12.8	257	60	74	43	57	117	185	341	28	21	7.33
22	$\frac{7}{8}$	15.5	290	71	88	52	62	133	207	383	31	21	9.91



Green Pin® Self Locking Hook CL GR8

Grade 8 clevis self locking hook

- **Material:** alloy steel, grade 8, quenched and tempered
- **Safety factor:** MBL equals 4 x WLL
- **Finish:** painted yellow (J), red (R) or white
- **Temperature range:** -40°C up to +200°C
- **Certification:** 2.1 2.2 MPI³



GKC

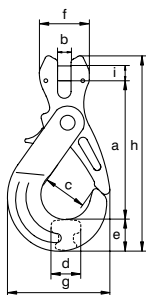

for chain diameter		working load limit	length	width	width opening	thickness	width	width outside	width outside	length	diameter pin	weight each
mm	inch											
7 - 8	$\frac{1}{4} - \frac{5}{16}$	2	85	9	32	17	25	32	77	136	9	0.55
10	$\frac{3}{8}$	3.2	116	12	43	24	29	42	92	168	13	1.02
13	$\frac{1}{2}$	5.4	153	15	47	32	34	54	111	218	16	2.01
16	$\frac{5}{8}$	8.2	166	19	62	37	46	66	142	247	20	3.7
18 - 20	$\frac{3}{4}$	12.8	215	23	74	43	57	80	185	312	24	7.59
22	$\frac{7}{8}$	15.5	242	25	88	52	62	98	207	353	28	10.3



Green Pin® Self Locking Hook S EN 1677-3 GR8

Grade 8 swivel self locking hook EN 1677-3



XLE

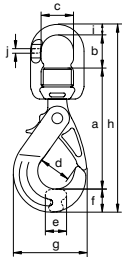

- **Material:** alloy steel, grade 8, quenched and tempered
- **Safety factor:** MBL equals 4 x WLL
- **Standard :** EN 1677-3
- **Finish:** painted yellow (J), red (R) or white
- **Temperature range:** -40°C up to +200°C
- **Certification:** 2.1 2.2 3.1 MPI^b DGUV
- **Note:** equipped with needle roller thrust bearing to enable rotation under load

for chain diameter		working load limit	length	length inside	width inside	width opening	thickness	width	width outside	length	diameter	thickness	weight each
mm	inch	t	a mm	b mm	c mm	d mm	e mm	f mm	g mm	h mm	i mm	j mm	kg
5 - 6	$\frac{3}{16} - \frac{7}{32}$	1.12	122	32	32	32	16	26	77	192	12	6	0.78
7-8	$\frac{1}{4} - \frac{5}{16}$	2	148	39	37	43	23	29	92	231	14	8	1.39
10	$\frac{3}{8}$	3.2	183	46	48	47	32	35	111	282	16	11	2.56
13	$\frac{1}{2}$	5.4	214	57	58	61	37	45	142	336	21	14	4.56
16	$\frac{5}{8}$	8.2	269	65	73	74	39	56	185	416	25	17	9.37
18 - 20	$\frac{3}{4}$	12.8	303	87	82	88	51	63	207	480	25	22	12.7



Green Pin® Self Locking Hook S GR8

Grade 8 swivel self locking hook



GKE

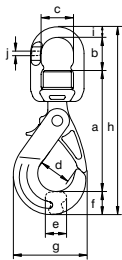

- **Material:** alloy steel, grade 8, quenched and tempered
- **Safety factor:** MBL equals 4 x WLL
- **Finish:** painted yellow (J), red (R) or white
- **Temperature range:** -40°C up to +200°C
- **Certification:** 2.1 2.2 MPI^b
- **Note:** equipped with needle roller thrust bearing to enable rotation under load

for chain diameter		working load limit	length	length inside	width inside	width opening	thickness	width	width outside	length	diameter	thickness	weight each
mm	inch	t	a mm	b mm	c mm	d mm	e mm	f mm	g mm	h mm	i mm	j mm	kg
7 - 8	$\frac{1}{4} - \frac{5}{16}$	2	122	33	32	32	17	25	77	192	12	6	0.77
10	$\frac{3}{8}$	3.2	148	40	37	43	24	29	92	231	14	8	1.38
13	$\frac{1}{2}$	5.4	185	47	48	47	32	34	111	282	16	11	2.56
16	$\frac{5}{8}$	8.2	213	60	58	61	37	46	142	339	21	14	4.58
18 - 20	$\frac{3}{4}$	12.8	268	62	73	74	43	57	185	417	25	17	9.51
22	$\frac{7}{8}$	15.5	305	88	82	90	52	62	207	480	25	22	12.85



Green Pin® Self Locking Hook SCL EN 1677-3 GR8

Grade 8 swivel clevis self locking hook EN 1677-3



XLBA

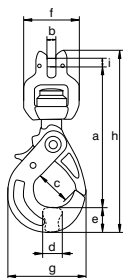

- **Material:** alloy steel, grade 8, quenched and tempered
- **Safety factor:** MBL equals 4 x WLL
- **Standard:** EN 1677-3
- **Finish:** painted red (R) or white
- **Temperature range:** -40°C up to +200°C
- **Certification:** 2.1 2.2 3.1 MPI[®] DGUV
- **Note:** equipped with needle roller thrust bearing to enable rotation under load

for chain diameter		working load limit	length	width	width opening	thickness	width	width outside	width outside	length	diameter pin	weight each
mm	inch	t	a mm	b mm	c mm	d mm	e mm	f mm	g mm	h mm	i mm	kg
5	³ / ₁₆	0.8	148	7	32	17	27	56	77	188	6	0.7
6	⁷ / ₃₂	1.12	148	7	32	17	27	56	77	188	8	0.8
7 - 8	¹ / ₄ - ⁵ / ₁₆	2	176	9	43	24	31	65	92	221	9	1.4
10	³ / ₈	3.2	214	12	47	32	37	79	111	271	13	2.6
13	¹ / ₂	5.4	250	15	61	37	47	96	142	325	16	4.7
16	⁵ / ₈	8.2	319	19	74	43	67	121	185	411	20	9.8



Green Pin® Grab Hook E EN 1677-1 GR8

Grade 8 eye grab hook EN 1677-1

- **Material:** alloy steel, grade 8, quenched and tempered
- **Safety factor:** MBL equals 4 x WLL
- **Standard :** EN 1677-1
- **Finish:** painted yellow (J), red (R) or white
- **Temperature range:** -40°C up to +200°C
- **Certification:** 2.1 2.2 3.1 * MPI^b * DGUV *



CRO

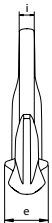
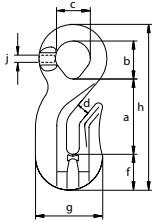

for chain diameter		working load limit	length		inside	inside	opening	thickness	width	width outside	length outside	width	thickness	weight each
mm	inch		a	b	length eye	width eye								
6	7/32	1.12	41	24	23	8	24	20	42	94	9	6	0.25	
7 - 8	1/4 - 5/16	2	53	27	26	10	33	23	53	115	10	8	0.45	
10	3/8	3.2	65	38	36	12	40	29	66	146	14	10	0.91	
13	1/2	5.4	83	42	41	15	56	40	88	183	16	12	1.99	
16	5/8	8.2	103	44	41	18	66	43	96	211	20	20	2.49	
20	3/4	12.8	130	37	37	22	75	48	128	241	26	26	4.3	
22	7/8	15.5	120	44	44	25	77	57	132	247	26	26	8.5	
26	1	21.6	158	46	46	30	100	82	177	320	32	32	14.7	
32	1 1/4	32.8	210	57	57	38	91	88	215	395	39	39	18	

* Excluding sizes 20 mm, 22 mm, 26 mm and 32 mm



Green Pin® Grab Hook CL EN 1677-1 GR8

Grade 8 clevis grab hook EN 1677-1

- **Material:** alloy steel, grade 8, quenched and tempered
- **Safety factor:** MBL equals 4 x WLL
- **Standard :** EN 1677-1
- **Finish:** painted yellow (J), red (R) or white
- **Temperature range:** -40°C up to +200°C
- **Certification:** 2.1 2.2 3.1 MPI^b



CRC

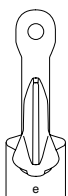
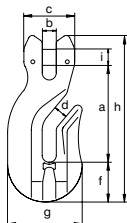

for chain diameter		working load limit	length	width	width outside	opening	thickness	width	width outside	length outside	diameter pin	weight each
mm	inch											
6	7/32	1.12	52	7	28	7	24	19	42	86	8	0.28
7 - 8	1/4 - 5/16	2	64	9	32	10	33	23	53	104	9	0.45
10	3/8	3.2	75	12	42	12	40	29	66	127	13	0.88
13	1/2	5.4	103	15	54	15	56	40	88	173	16	2.17
16	5/8	8.2	127	19	68	18	65	43	96	208	20	2.81



Green Pin® Excavator Hook GR8

Grade 8 excavator hook



GH

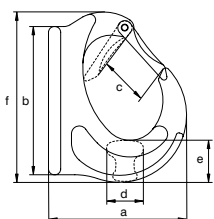

- **Material:** alloy steel, grade 8, quenched and tempered
- **Safety factor:** MBL equals 4 x WLL
- **Finish:** painted yellow (J) or white
- **Temperature range:** -40°C up to +200°C
- **Certification:** 2.1 2.2 MPI^b
- **Note:** welding must be done in accordance with DIN 5817 resp. 15429, by a qualified welder according to EN 287-1

working load limit	width	length	width opening	thickness	width	length	width	width	weight each
t	a mm	b mm	c mm	d mm	e mm	f mm	g mm	h mm	kg
1	72	78	25	19	28	108	31	26	0.52
2	91	83	33	20	28	113	31	34	0.7
3	105	105	33	26	32	129	31	34	1.15
4	121	130	35	27	37	148	41	38	1.66
5	138	149	43	28	45	167	41	44	2.36
8	145	148	43	41	52	173	41	51	3.32
10	178	197	60	46	61	227	50	66	6.44
15	185	223	65	60	70	251	55	80	9.7

INFO



Green Pin® Foundry Hook E GR8

Grade 8 eye foundry hook



CFO

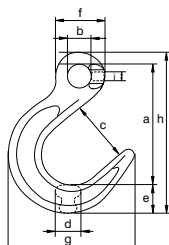

- **Material:** alloy steel, grade 8, quenched and tempered
- **Safety factor:** MBL equals 4 x WLL
- **Finish:** painted yellow (J), red (R) or white
- **Temperature range:** -40°C up to +200°C
- **Certification:** 2.1 2.2 3.1 * MPI^b * DGUV *
- **Note:** from 8.2 t without flat part

for chain diameter		working load limit	length	diameter eye inside	width opening	thickness	width	diameter eye outside	width outside	length	thickness	weight each
mm	inch	t	a mm	b mm	c mm	d mm	e mm	f mm	g mm	h mm	i mm	kg
6	7/32	1.12	93	18	47	17	22	38	97	125	7	0.33
7 - 8	1/4 - 5/16	2	124	24	63	22	30	51	129	166	9	0.78
10	3/8	3.2	157	33	79	28	36	66	160	208	11	1.5
13	1/2	5.4	190	44	93	36	46	85	198	256	14	3
16	5/8	8.2	205	35	95	45	52	88	204	284	24	4.2
18 - 20	3/4	12.8	235	40	111	53	55	92	228	315	25	7.8
22	7/8	15.5	265	46	123	66	71	110	258	268	32	9.9
26	1	21.6	305	54	133	65	81	120	277	420	33	13.8
32	1 1/4	32.8	327	60	155	84	96	131	333	459	35	24.5

* Excluding sizes 16 mm, 18/20 mm, 22 mm, 26 mm and 32 mm



Green Pin® Flat Web Sling Hook GR8

Grade 8 flat web sling hook

- **Material:** alloy steel, grade 8, quenched and tempered
- **Safety factor:** MBL equals 4 x WLL
- **Finish:** painted yellow or white
- **Temperature range:** -40°C up to +200°C
- **Certification:** 2.1 2.2 3.1 MPI^b



CST

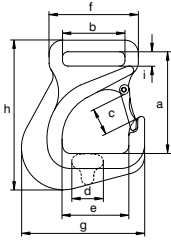

working load limit	length	inside width eye	width opening	thickness	width inside	width outside	width outside	length outside	width inside	weight each
t	a mm	b mm	c mm	d mm	e mm	f mm	g mm	h mm	i mm	kg
3	132	79	34	40	75	113	148	199	25	2.63



Green Pin® Flat Web Sling Safety Hook GR8

Grade 8 flat web sling self locking hook

- **Material:** alloy steel, grade 8, quenched and tempered
- **Safety factor:** MBL equals 4 x WLL
- **Finish:** painted yellow or white
- **Temperature range:** -40°C up to +200°C
- **Certification:** 2.1 2.2 3.1 MPI^b



XLS

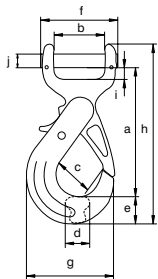

working load limit	length	width	width opening	thickness	width	width outside	width outside	length outside	length inside	diameter pin	weight each
t	a mm	b mm	c mm	d mm	e mm	f mm	g mm	h mm	i mm	j mm	kg
2	161	62	47	32	35	94	111	222	18	16	2.11



Green Pin® Sling Hook E GR10

Grade 10 eye sling hook

- **Material:** alloy steel, grade 10, quenched and tempered
- **Safety factor:** MBL equals 4 x WLL
- **Finish:** painted blue
- **Temperature range:** -40°C up to +200°C
- **Certification:** 2.1 2.2 3.1 MPI[®] DGVU
- **Note:** from 10 t without flat part



UCSO

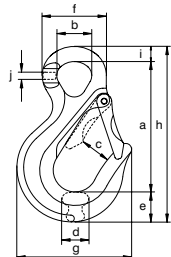

for chain diameter		working load limit	length	diameter inside eye	width opening	thickness	width	diameter eye outside	width outside	length	width	thickness	weight each
mm	inch												
6	7/32	1.4	84	23	26	15	20	43	72	114	10	6	0.28
8	9/32 - 5/16	2.6	103	26	30	20	24	51	87	139	12	8	0.52
10	3/8	4	128	35	33	24	29	65	106	172	15	10	1.09
13	1/2	6.8	152	41	37	32	39	77	133	209	18	12	1.94
16	5/8	10.3	190	52	44	40	44	94	165	255	21	16	3.51
20	3/4	16	237	60	61	49	62	115	208	327	28	21	7.1



Green Pin® Sling Hook CL GR10

Grade 10 clevis sling hook

- **Material:** alloy steel, grade 10, quenched and tempered
- **Safety factor:** MBL equals 4 x WLL
- **Finish:** painted blue
- **Temperature range:** -40°C up to +200°C
- **Certification:** 2.1 2.2 3.1 MPI[®] DGVU



UCSC

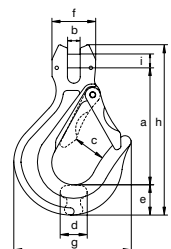

for chain diameter		working load limit	length	width	width opening	thickness	width	width outside	width outside	length outside	diameter pin	weight each
mm	inch											
6	7/32	1.4	75	7	26	15	20	28	72	108	8	0.29
	9/32	1.95	95	9	30	20	24	32	87	136	10	0.58
8	5/16	2.6	95	9	30	20	24	32	87	136	10	0.58
10	3/8	4	113	12	33	24	29	42	106	164	13	1.11
13	1/2	6.8	138	15	37	32	39	54	133	208	16	2.12
16	5/8	10.3	161	19	44	40	44	68	165	240	20	3.78
20	3/4	16	198	22	61	49	62	82	208	305	24	7.49



Green Pin® Self Locking Hook E GR10

Grade 10 eye self locking hook

- **Material:** alloy steel, grade 10, quenched and tempered
- **Safety factor:** MBL equals 4 x WLL
- **Finish:** painted blue
- **Temperature range:** -40°C up to +200°C
- **Certification:** 2.1 2.2 3.1 MPI^b DGUV



UXLO

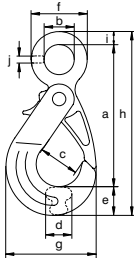

for chain diameter		working load limit	length	diameter inside eye	width opening	thickness	width	width outside	width outside	length	width	thickness	weight each
mm	inch	t	a mm	b mm	c mm	d mm	e mm	f mm	g mm	h mm	i mm	j mm	kg
6	7/32	1.4	111	24	32	16	26	47	77	147	11	7	0.51
8	9/32 - 5/16	2.6	134	29	43	23	29	57	92	176	14	7	0.91
10	3/8	4	168	35	47	32	35	69	111	219	17	10	1.79
13	1/2	6.8	199	46	61	37	45	87	142	264	20	13	3.36
16	5/8	10.3	247	59	74	43	56	111	185	328	26	16	7
20	3/4	16	283	70	90	52	61	126	205	372	28	20	9.22



Green Pin® Self Locking Hook CL GR10

Grade 10 clevis self locking hook

- **Material:** alloy steel, grade 10, quenched and tempered
- **Safety factor:** MBL equals 4 x WLL
- **Finish:** painted blue
- **Temperature range:** -40°C up to +200°C
- **Certification:** 2.1 2.2 3.1 MPI^b DGUV



UXLC

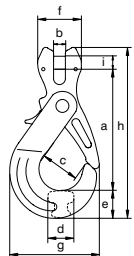

for chain diameter		working load limit	length	width	width opening	thickness	width	width outside	width outside	length	diameter pin	weight each
mm	inch	t	a mm	b mm	c mm	d mm	e mm	f mm	g mm	h mm	i mm	kg
6	7/32	1.4	92	7	32	16	26	28	77	131	8	0.49
	9/32	1.95	116	9	43	23	29	32	92	161	10	0.91
8	5/16	2.6	116	9	43	23	29	32	92	161	10	0.91
10	3/8	4	143	12	47	32	35	42	111	200	13	1.77
13	1/2	6.8	167	15	61	37	45	54	142	242	16	3.33
16	5/8	10.3	201	19	74	43	54	68	185	293	20	6.75
20	3/4	16	234	23	90	52	61	82	205	339	24	9.57



Green Pin® Self Locking Hook S GR10

Grade 10 self locking hook with swivel

- **Material:** alloy steel, grade 10, quenched and tempered
- **Safety factor:** MBL equals 4 x WLL
- **Finish:** painted blue
- **Temperature range:** -40°C up to +200°C
- **Certification:** 2.1 2.2 3.1 MPI[®] DGUV
- **Note:** equipped with needle roller thrust bearing to enable rotation under load



UXLE

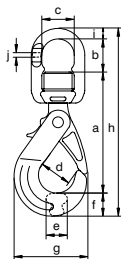

for chain diameter		working load limit	length	length inside	width inside	width opening	thickness	width	width outside	length	diameter	thickness	weight each
mm	inch	t	a mm	b mm	c mm	d mm	e mm	f mm	g mm	h mm	i mm	j mm	kg
6	⁷ / ₃₂	1.4	122	32	32	32	16	26	77	192	12	6	0.78
8	⁹ / ₃₂ - ⁵ / ₁₆	2.6	148	39	37	43	23	29	92	231	14	8	1.39
10	³ / ₈	4	183	46	48	47	32	35	111	282	16	11	2.56
13	¹ / ₂	6.8	214	57	58	61	37	45	142	336	21	14	4.56
16	⁵ / ₈	10.3	269	65	73	74	39	56	185	416	24	17	9.37
20	³ / ₄	16	304	87	82	90	52	61	205	476	24	21	12.7



Green Pin® Grab Hook E GR10

Grade 10 eye grab hook

- **Material:** alloy steel, grade 10, quenched and tempered
- **Safety factor:** MBL equals 4 x WLL
- **Finish:** painted blue
- **Temperature range:** -40°C up to +200°C
- **Certification:** 2.1 2.2 3.1 MPI^b



UCRO

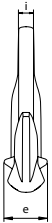
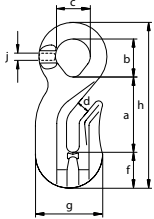

for chain diameter		working load limit	length	inside length eye	inside width eye	opening	thickness	width	width outside	length outside	width	thickness	weight each
mm	inch	t	a mm	b mm	c mm	d mm	e mm	f mm	g mm	h mm	i mm	j mm	kg
6	7/32	1.4	41	24	23	8	24	20	42	94	9	6	0.25
13	1/2	6.8	83	42	41	15	56	40	88	183	16	12	1.99



Green Pin® Grab Hook CL GR10

Grade 10 clevis grab hook

- **Material:** alloy steel, grade 10, quenched and tempered
- **Safety factor:** MBL equals 4 x WLL
- **Finish:** painted blue
- **Temperature range:** -40°C up to +200°C
- **Certification:** 2.1 2.2 3.1 MPI^b



UCRC

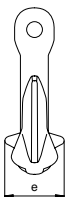
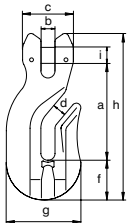

for chain diameter		working load limit	length	width	width outside	opening	thickness	width	width outside	length outside	diameter pin	weight each
mm	inch	t	a mm	b mm	c mm	d mm	e mm	f mm	g mm	h mm	i mm	kg
6	7/32	1.4	52	7	28	7	24	19	42	86	8	0.28
13	1/2	6.8	103	15	54	15	56	40	88	173	16	2.17



Green Pin® Foundry Hook E GR10

Grade 10 eye foundry hook

- **Material:** alloy steel, grade 10, quenched and tempered
- **Safety factor:** MBL equals 4 x WLL
- **Finish:** painted blue
- **Temperature range:** -40°C up to +200°C
- **Certification:** 2.1 2.2 3.1 MPI® DGUV



UCFO

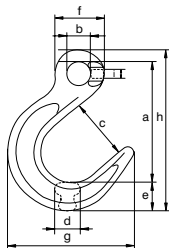

for chain diameter		working load limit	length	diameter eye inside	width opening	thickness	width	diameter eye outside	width outside	length	thickness	weight each
mm	inch	t	a mm	b mm	c mm	d mm	e mm	f mm	g mm	h mm	i mm	kg
6	7/32	1.4	93	18	48	17	22	38	97	124	6	0.33
8	9/32 - 5/16	2.6	124	25	63	22	29	50	129	165	8	0.78
10	3/8	4	157	33	80	28	36	65	161	208	10	1.5
13	1/2	6.8	190	44	96	36	46	84	198	256	13	3



Green Pin Tycan® Grab Hook CL GR10

Grade 10 clevis grab hook

- **Material:** alloy steel, grade 10, quenched and tempered
- **Safety factor:** MBL equals 4 x WLL and MBL equals 2 x Lashing Capacity
- **Finish:** painted blue
- **Temperature range:** -40°C up to +200°C
- **Certification:** 2.1 2.2 3.1 MPI®
- **Compatible with:** FCHLIFT1525; 5t (as shortening hook)
FCHLASH1525; 10t (to connect to the loadbinder)



UCRCT

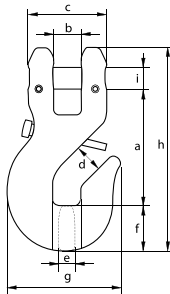

for chain size	working load limit	lashing capacity	length	width	width outside	opening	thickness	width	width outside	length outside	diameter pin	weight each
mm	t	t	a mm	b mm	c mm	d mm	e mm	f mm	g mm	h mm	i mm	kg
11x15	2.6		87	17	44	15	13	23	65	109	13	0.55
11x20	4		110	22	57	20	16	29	85	138	16	1.03
15x25	5	10	102	24	68	25	16	40	99	178	20	2
13x30	6.8		140	32	74	30	20	40	102	177	20	1.92

In inch

for chain size	working load limit	lashing capacity	length	width	width outside	opening	thickness	width	width outside	length outside	diameter pin	weight each
inch	t	t	inch	inch	inch	inch	inch	inch	inch	inch	inch	lbs
7/16x19/32	2.6		3 7/16	21/32	1 3/4	19/32	1/2	29/32	2 9/16	4 10/32	1/2	1.21
7/16x25/32	4		4 11/32	7/8	2 1/4	25/32	5/8	1 5/32	3 1/3	5 7/16	5/8	2.27
19/32x1	5	10	4 1/32	15/16	2 11/16	1	5/8	1 8/16	3 29/32	7	25/32	4.4
1/2x1 3/16	6.8		5 1/2	1 1/4	2 29/32	1 3/16	25/32	1 8/16	4 1/32	6 31/32	25/32	4.23



UCSCT

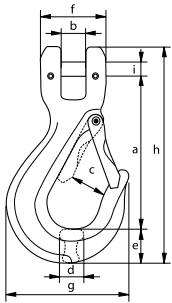

Green Pin Tycan® Sling Hook CL GR10

Grade 10 clevis sling hook

- **Material:** alloy steel, grade 10, quenched and tempered
- **Safety factor:** MBL equals 4 x WLL
- **Finish:** painted blue
- **Temperature range:** -40°C up to +200°C
- **Certification:** 2.1 2.2 3.1 MPI¹
- **Compatible with:** FCHLIFT; 2.6t, 4t and 6.8t

for chain size	working load limit	length	width	width opening	thickness	width	width outside	width outside	length outside	diameter pin	weight each
mm	t	a mm	b mm	c mm	d mm	e mm	f mm	g mm	h mm	i mm	kg
11x15	2.6	112	17	30	20	24	44	87	158	13	0.73
11x20	4	129	22	33	24	29	57	106	186	16	1.31
13x30	6.8	159	32	37	32	39	74	133	235	20	2.56

In inch

for chain size	working load limit	length	width	width opening	thickness	width	width outside	width outside	length outside	diameter pin	weight each
inch	t	a inch	b inch	c inch	d inch	e inch	f inch	g inch	h inch	i inch	lbs
7/16 X 19/32	2.6	4 12/32	21/32	1 3/16	25/32	15/16	1 3/4	3 7/16	6 7/32	1/2	1.61
7/16 X 25/32	4	5 3/32	7/8	1 5/16	15/16	1 5/32	2 1/4	4 3/16	7 5/16	5/8	2.88
1/2 X 1 3/16	6.8	6 1/4	1 1/4	1 15/32	1 1/4	1 17/32	2 29/32	5 1/4	9 1/4	25/32	5.64



P-6720A

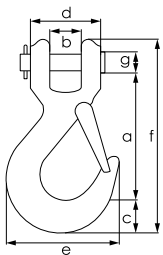

Clevis Hook for Green Pin Tycan®

Grade 10 clevis hook with safety latch for use with Green Pin Tycan® Chain

- **Material:** alloy steel
- **Safety factor:** MBL equals 4 x WLL and MBL equals 2 x Lashing Capacity
- **Finish:** painted blue
- **Certification:** 2.1 2.2 CE
- **Compatible with:** FCHLIFT1525, FCHLASH1525

for chain size	working load limit	lashing capacity	length	width	width	width outside	width outside	length outside	diameter pin	weight each
mm	t	t	a mm	b mm	c mm	d mm	e mm	f mm	g mm	kg
15x25	5	10	110	26	40	62	113	179	16	1.25

In inch

for chain size	working load limit	lashing capacity	length	width	width	width outside	width outside	length outside	diameter pin	weight each
inch	t	t	a inch	b inch	c inch	d inch	e inch	f inch	g inch	lbs
19/32 X 1	5	10	4 11/32	1	1 9/16	2 7/16	4 29/64	7	5/8	2.75

C

S-Hook

- **Material:** high tensile steel
- **Safety factor:** MBL equals 4 x LC
- **Finish:** painted red
- **Certification:** 2.1 2.2



S

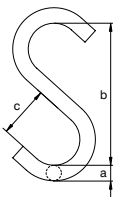

lashing capacity	diameter	length	width	weight each
t	a mm	b mm	c mm	kg
0.2	10	80	30	0.11
0.3	13	100	40	0.24
0.5	16	130	50	0.47
0.75	18	170	60	0.8
1	20	185	64	1.02
1.2	22	200	69	1.4
1.5	24	230	80	1.95
2	32	270	90	3.5
3	36	325	98	5.16
4	40	350	112	7.48
5	45	400	130	10.81
6	51	450	150	16.2

C

S Eye Hook

- **Material:** high tensile steel
- **Safety factor:** MBL equals 4 x LC
- **Finish:** painted red
- **Certification:** 2.1 2.2



SO

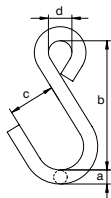

lashing capacity	diameter	length	width	width inside	weight each
t	a mm	b mm	c mm	d mm	kg
0.2	10	80	30	16	0.11
0.3	13	100	40	21	0.25
0.5	16	130	50	25	0.48
0.75	18	160	59	34	0.76
1	20	180	65	42	1.07
1.2	22	195	69	37	1.4
1.5	24	220	79	40	1.79
2	32	260	90	46	3.8
3	36	320	99	52	5.35
4	40	360	115	59	7.85
5	45	390	126	68	10.95
6	51	450	150	77	15.2



Clevis lashing hook



- **Material:** alloy steel, grade 8, quenched and tempered
- **Safety factor:** MBL equals 2 x LC
- **Finish:** painted red
- **Certification:** 2.1 2.2

CAC

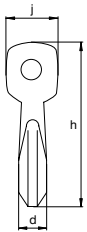
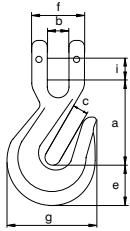

for chain diameter		lashing capacity	length	width	width	thickness	width	width outside	width outside	length outside	diameter pin	width outside	weight each
mm	inch	t	a mm	b mm	c mm	d mm	e mm	f mm	g mm	h mm	i mm	j mm	kg
8	⁵ / ₁₆	4	66	10	10	16	23	38	56	107	9	19	0.34
10	³ / ₈	6.3	82	13	13	25	31	46	77	137	12	27	0.85
13	¹ / ₂	10	113	17	17	30	43	61	106	185	16	36	1.98
16	⁵ / ₈	16	130	20	20	38	49	69	120	215	20	40	2.95
18/20	³ / ₄	25	152	24	34	40	58	88	142	254	21	44	5.12
22	⁷ / ₈	30	178	28	27	54	66	101	164	295	24	58	8.92

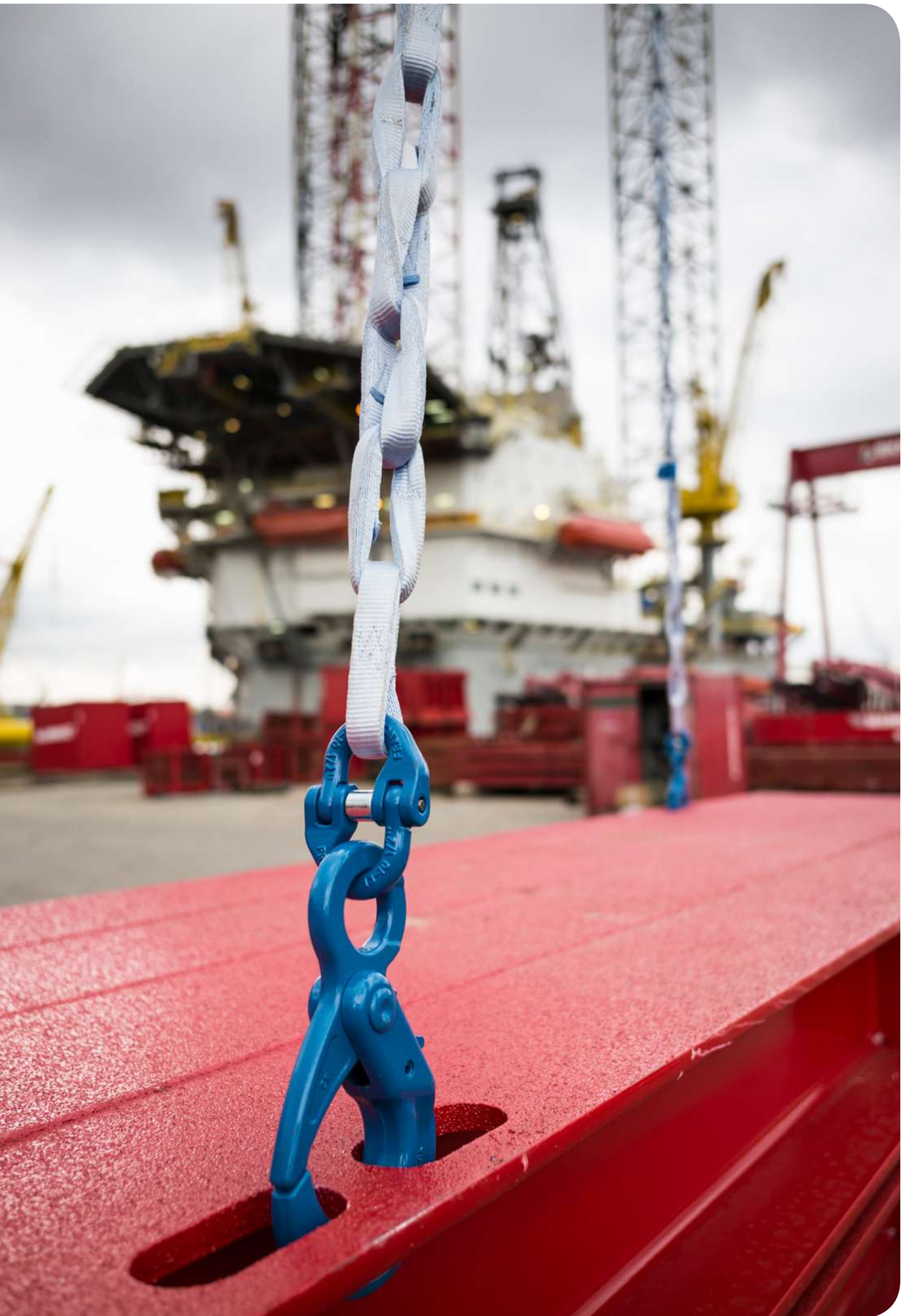

LIFTING EYES



Applications

Eye bolts and eye nuts are used for lifting machines, appliances or any other objects which cannot be lifted by hand or by fork lift truck.

Range

Green Pin® offers eye bolts and nuts in grade 8 and stainless steel. To complement the Green Pin® assortment, Van Beest offers a wide range of other lifting eye bolts, eye nuts and lifting points, from M6 up to M100, with WLLs from 0.07 t up to 40 t.

Design

Grade 8 lifting points are made from alloy steel. The threading is standard metric. Eye bolts and eye nuts are drop forged from C15 steel.

Each eye bolt and eye nut is generally marked with:

- Working Load Limit - e.g. 0.7 t, valid for in-line lifting; or 1.5t
- manufacturer's symbol - e.g. Bs or GP
- thread diameter - e.g. M16 or 5/8"-11UNC
- traceability code - e.g. A1 or HA
- steel grade - C15 or 8 (8 only on AL, EL, ADA and PAS)
- item code - e.g. EL, AL, ADA, OL
- CE conformity code - CE

Finish

The eye bolts and eye nuts can be painted or electro-galvanized. Grade 8 lifting points are painted and supplied with a protective cover over the threads. Do not remove the cover until use. Grade 8 products were painted yellow or red under the Excel® brand. However, grade 8 products under the Green Pin® brand will be painted white. Grade 10 products are painted blue and will remain so.

Certification

Specific details of certificate availability can be found on each product page. Please verify your certification requirements at the time of order.

Instructions for use

Eye bolts and eye nuts should be inspected before use to ensure that:

- all markings are legible;
- an eye bolt or eye nut with the correct WLL has been selected;
- the thread is undamaged and clean;
- eye bolts and eye nuts are free from nicks, gouges and cracks;
- never grind, machine or cut an eye bolt or eye nut;
- eye bolts or eye nuts may not be heat treated as this may affect their WLL;
- never modify, repair or reshape an eye bolt or eye nut by machining, welding, heating or bending as this may affect the WLL;
- lifting points and the other components are of the same steel grade;
- lifting points should never be side loaded (except ADA);
- always make sure that the lifting point is supporting the load correctly;
- lifting points should be seated well down in the hook;
- lifting points are not distorted or unduly worn;
- the WLL for complementary eyebolts/nuts are valid for in-line lifting only and have to be reduced for non-axial loading. For further details please refer to the standard: DIN 580 for eye bolts or DIN 582 for eye nuts;
- the WLL for AL, OL and EL eyebolts/nuts are valid for in-line lifting only up to an angle of 30°. The WLL decreases significantly above 30°. We recommend the use of pivoting and rotation hoist rings (ADA) when the angle is above 30°.
- when used as a lifting device, the eye bolt or eye nut should always be fully screwed into the load in such a way that it fits properly against the load.

Assembly

The thread length should be adapted to the material of the load. For hard materials, the thread length must not be smaller than 1.5 times the diameter (e.g. M20, minimum length 30 mm). For soft materials such as aluminium or brass, a length of 3 times the diameter is needed. For soft materials, consider using a longer length and through-hole mounting with a nut and washer on the other side. The nut on the bolt should at least be Class 8, but Class 10 or 12 is recommended.

The bolt thread and the tapped hole in the load must be compatible and both must be in a good condition. The tapping should be at least 20% deeper than the thread length. The surface should be flat and perpendicular to the thread to enable full contact with the lifting point.

The material to which the lifting point is attached should be strong enough to withstand lifting forces without any deformation. The lifting points must fit perfectly on the material of the load to be lifted. Full contact between the lifting point and the surface is required.



1

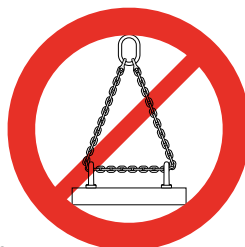

2

1. The lifting points should match the size of the hook, so that they can be correctly positioned into the hook.
2. Never use a sling as a loop between two lifting points. Consider the centre of gravity of the load to position the lifting points (symmetrical to the centre). The tapping must be positioned at a distance of at least 3 times the diameter of the bolt from the edge of the load.

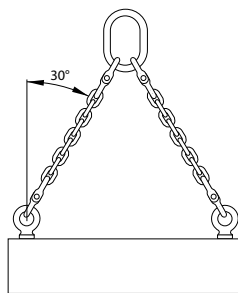

For the AL, EL and OL lifting points, the application angle may be up to 30° as indicated in the illustration. The WLL decreases significantly above 30°. We recommend the use of pivoting and rotating hoist rings (ADA) when the angle is above 30°.

Fasten these lifting points by hand and without the use of any tools or leverage. The lifting point has to be tightened just deep enough so that the lower edge connects to the surface of the load.

For the ADA pivoting and rotating hoist rings, tighten the threaded bolt to the recommended torque (see the product table). Check the torque periodically, because the bolts may come loose during use. Check whether the hoist ring can pivot and rotate freely in all directions.

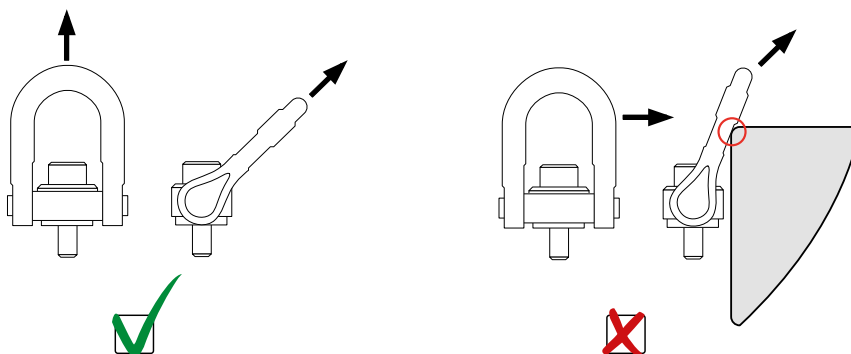

Products must be regularly inspected in accordance with the safety standards valid in the country of use. This is required because the products in use may be affected by issues such as wear, misuse and overloading, which may lead to deformation and alteration of the material structure. Inspection should take place at least every six months and more frequently when the products are used in severe operating conditions.

Green Pin® Lifting Eye GR8

Grade 8 lifting eye

- **Material:** alloy steel, grade 8, quenched and tempered
- **Safety factor:** MBL equals 5 x WLL
- **Finish:** painted red or white
- **Temperature range:** -40°C up to +200°C
- **Certification:** 2.1 2.2 3.1 MPI[®] CE



AL

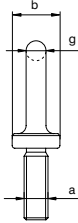
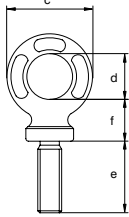

working load limit	diameter thread	diameter base	diameter eye outside	diameter eye inside	length	thickness base	diameter	weight each
t	a mm	b mm	c mm	d mm	e mm	f mm	g mm	kg
0.2	M6 x 1.00	20	34	20	20	17	7	0.05
0.4	M8 x 1.25	20	34	20	24	17	7	0.07
0.7	M10 x 1.50	20	38	22	30	19	8	0.08
1	M12 x 1.75	25	47	27	36	23	10	0.14
1.2	M14 x 2.00	30	57	30	40	27	14	0.25
1.5	M16 x 2.00	36	63	35	53	31	14	0.39
2	M18 x 2.50	36	63	35	53	31	14	0.38
2.5	M20 x 2.50	40	72	40	58	34	16	0.58
3	M22 x 2.50	42	82	45	64	38	19	1.01
4	M24 x 3.00	55	95	55	84	40	20	1.12
5	M27 x 3.00	55	95	55	84	40	20	1.18
6	M30 x 3.50	60	108	60	99	49	24	1.84
7	M33 x 3.50	60	108	60	99	49	24	2.01
8	M36 x 4.00	65	118	68	117	47	25	2.44
9	M39 x 4.00	65	118	68	117	47	25	2.62
10	M42 x 4.50	70	142	80	135	61	31	5.41
15	M45 x 4.50	70	142	80	135	61	31	4.16
18	M48 x 5.00	95	181	97	150	68	42	8.22
20	M52 x 5.00	95	181	97	150	68	42	8.55
25	M56 x 5.50	95	181	97	150	68	42	8.85
30	M60 x 5.50	95	181	97	150	68	42	9.16
36	M64 x 6.00	95	181	97	150	68	42	9.55



Green Pin® Lifting Eye Length as DIN580 GR8

Grade 8 lifting eye length as DIN580



ALDIN

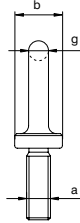
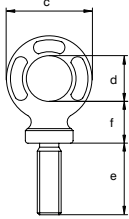

- **Material:** alloy steel, grade 8, quenched and tempered
- **Safety factor:** MBL equals 5 x WLL
- **Finish:** painted red or white
- **Temperature range:** -40°C up to +200°C
- **Certification:** 2.1 2.2 3.1 MPI[®] CE

working load limit	diameter thread	diameter base	diameter eye outside	diameter eye inside	length	thickness base	diameter	weight each
t	a mm	b mm	c mm	d mm	e mm	f mm	g mm	kg
0.2	M6 x 1.00	20	34	20	13	17	7	0.05
0.4	M8 x 1.25	20	34	20	13	17	7	0.05
0.7	M10 x 1.50	20	38	22	17	19	8	0.07
1	M12 x 1.75	25	47	27	21	23	10	0.13
1.2	M14 x 2.00	30	57	30	27	27	14	0.24
1.5	M16 x 2.00	36	63	35	27	31	14	0.34
2	M18 x 2.50	36	63	35	30	31	14	0.38
2.5	M20 x 2.50	40	72	40	30	34	16	0.52
3	M22 x 2.50	42	82	45	36	38	19	0.67
4	M24 x 3.00	55	95	55	36	40	20	0.99
5	M27 x 3.00	55	95	55	45	40	20	1.08
6	M30 x 3.50	60	108	60	45	49	24	1.66
7	M33 x 3.50	60	108	60	54	49	24	1.74
8	M36 x 4.00	65	118	68	54	47	25	2.01
9	M39 x 4.00	65	118	68	63	47	25	2.08
10	M42 x 4.50	70	142	80	63	61	31	3.37
15	M45 x 4.50	70	142	80	68	61	31	3.47
18	M48 x 5.00	95	181	97	68	68	42	7.17
20	M52 x 5.00	95	181	97	78	68	42	7.25
25	M56 x 5.50	95	181	97	78	68	42	7.52
30	M60 x 5.50	95	181	97	90	68	42	7.78
36	M64 x 6.00	95	181	97	90	68	42	8.12



Green Pin® Lifting Eye UNC GR8

Grade 8 lifting eye UNC

- **Material:** alloy steel, grade 8, quenched and tempered
- **Safety factor:** MBL equals 5 x WLL
- **Finish:** painted red or white
- **Temperature range:** -40°C up to +200°C
- **Certification:** 2.1 2.2 3.1 MPI[®] CE



ALUNC

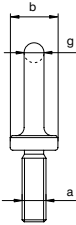
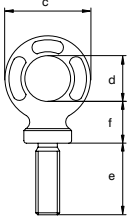

working load limit	diameter thread	diameter base	diameter eye outside	diameter eye inside	length	thickness base	diameter	weight each
t	a inch	b mm	c mm	d mm	e mm	f mm	g mm	kg
0.2	1/4 - 20UNC	20	34	20	20	17	7	0.05
0.55	5/16 - 18UNC	20	34	20	24	17	7	0.06
0.7	3/8 - 16UNC	20	38	22	30	19	8	0.08
1	1/2 - 13UNC	25	47	27	36	23	10	0.14
1.5	5/8 - 11UNC	36	63	35	53	31	14	0.38
2.5	3/4 - 10UNC	40	72	40	58	34	16	0.55
3	7/8 - 9UNC	42	82	45	64	38	19	0.81
4	1 - 8UNC	55	95	55	84	40	20	1.14
5	1 1/8 - 7UNC	55	95	55	84	40	20	1.21
6	1 1/4 - 7UNC	60	108	60	99	49	24	1.91
8	1 1/2 - 6UNC	65	118	68	117	47	25	2.52



Green Pin® Eye Nut GR8

Grade 8 eye nut



- **Material:** alloy steel, grade 8, quenched and tempered
- **Safety factor:** MBL equals 5 x WLL
- **Finish:** painted red or white
- **Temperature range:** -40°C up to +200°C
- **Certification:** 2.1 2.2 3.1 MPI ^h CE

EL

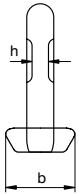
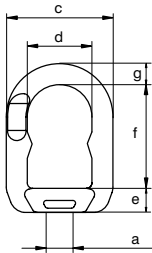

working load limit	diameter thread	diameter base	width	width inside	thickness base	length inside	diameter	thickness	weight each
t	a mm	b mm	c mm	d mm	e mm	f mm	g mm	h mm	kg
0.2	M6 x 1.00	31	51	30	14	44	11	6	0.15
0.4	M8 x 1.25	31	51	30	14	44	11	6	0.15
0.7	M10 x 1.50	31	51	30	14	44	11	6	0.15
1	M12 x 1.75	39	56	32	15	48	12	6	0.29
1.2	M14 x 2.00	39	56	32	15	48	12	6	0.29
1.5	M16 x 2.00	44	65	37	16	60	14	8	0.38
2	M18 x 2.50	44	65	37	16	60	14	8	0.38
2.5	M20 x 2.50	44	65	37	16	60	14	8	0.38
3	M22 x 2.50	52	79	48	21	75	16	11	0.63
4	M24 x 3.00	52	79	48	21	75	16	11	0.63
5	M27 x 3.00	52	79	48	21	75	16	11	0.63
6	M30 x 3.50	66	96	58	25	88	21	14	1.11
7	M33 x 3.50	66	96	58	25	88	21	14	1.11
8	M36 x 4.00	84	121	73	39	100	25	17	2.22
9	M39 x 4.00	84	121	73	39	100	25	17	2.22
10	M42 x 4.50	84	121	73	39	100	25	17	2.22
15	M45 x 4.50	90	132	82	42	121	25	22	2.73
18	M48 x 5.00	90	132	82	42	121	25	22	2.73

Green Pin® Rotating Hoist Ring GR8

Grade 8 rotating hoist ring

- **Material:** alloy steel, grade 8, quenched and tempered
- **Safety factor:** MBL equals 5 x WLL
- **Finish:** painted red or white
- **Temperature range:** -40°C up to +200°C
- **Certification:** 2.1 2.2 3.1 MPI® CE
- **Note:** WLL indicated hereunder are given in the worst conditions of use, i.e. 90°



ADA

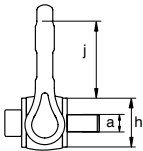
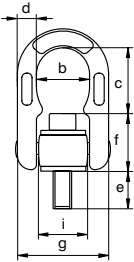

working load limit	diameter thread	width inside	length inside	diameter	length	thickness base	width outside	diameter base	diameter base	length inside	hex key	torque value	weight each
t	a mm	b mm	c mm	d mm	e mm	f mm	g mm	h mm	i mm	j mm	mm	Nm	kg
0.4	M8 x 1.25	35	41	13	18	35	68	34	38	43	6	6.5	0.43
0.7	M10 x 1.5	35	39	13	18	37	68	34	38	43	8	13	0.44
1	M12 x 1.75	35	36	13	22	39	68	34	38	43	10	22	0.46
1.3	M14 x 2.0	35	35	13	22	42	68	34	38	43	12	35	0.47
1.6	M16 x 2.0	35	42	13	28	43	68	34	38	52	14	55	0.52
2	M18 x 2.5	35	40	13	28	45	68	34	38	52	14	80	0.54
2.5	M20 x 2.5	35	38	13	32	47	68	34	38	52	17	110	0.59
3	M22 x 2.5	53	57	20	33	69	105	49	56	71	17	150	1.88
4	M24 x 3.0	53	55	20	39	71	105	49	56	71	19	190	1.93
5	M27 x 3.0	53	61	20	45	65	105	49	56	71	19	280	1.96
6.3	M30 x 3.5	53	61	20	45	65	105	49	56	71	19	380	2.03
7	M33 x 3.5	71	87	30	54	83	146	68	77	98	19	520	5.28
10	M36 x 4.0	71	87	30	54	84	146	68	77	98	19	600	5.35
10	M39 x 4.0	71	87	30	63	84	146	68	77	98	19	870	5.45
12.5	M42 x 4.5	71	87	30	63	84	146	68	77	98	19	1000	5.56



Green Pin® Rotating Hoist Ring UNC GR8

Grade 8 rotating hoist ring UNC



- **Material:** alloy steel, grade 8, quenched and tempered
- **Safety factor:** MBL equals 5 x WLL
- **Finish:** painted red or white
- **Temperature range:** -40°C up to +200°C
- **Certification:** 2.1 2.2 3.1 MPI^h CE
- **Note:** WLL indicated hereunder are given in the worst conditions of use, i.e. 90°

ADAUNC

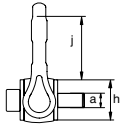
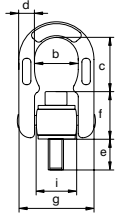

working load limit	diameter thread	width inside	length inside	diameter	length	thickness base	width outside	diameter base	diameter base	length inside	hex key	torque value	weight each
t	a inch	b mm	c mm	d mm	e mm	f mm	g mm	h mm	i mm	j mm	mm	Nm	kg
0.4	5/16 - 18UNC	35	41	13	18	35	68	34	38	43	6	6.5	0.43
0.6	3/8 - 16UNC	35	39	13	18	37	68	34	38	43	8	13	0.44
1	1/2 - 13UNC	35	36	13	24	39	68	34	38	43	10	22	0.46
1.7	5/8 - 11UNC	35	42	13	31	43	68	34	38	52	13	55	0.54
2.5	3/4 - 10UNC	35	38	13	31	47	68	34	38	52	16	110	0.55
3.5	7/8 - 9UNC	53	57	20	37	69	105	49	56	71	19	150	1.88
4.5	1 - 8UNC	53	55	20	43	71	105	49	56	71	19	190	1.93

Green Pin® Long Rotating Hoist Ring GR8

Grade 8 rotating hoist ring longer length

- **Material:** alloy steel, grade 8, quenched and tempered
- **Safety factor:** MBL equals 5 x WLL
- **Finish:** painted red or white
- **Temperature range:** -40°C up to +200°C
- **Certification:** 2.1 2.2 3.1 MPI® CE
- **Note:** WLL indicated hereunder are given in the worst conditions of use, i.e. 90°

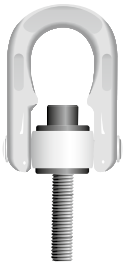

ADAL

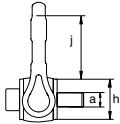
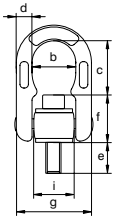

working load limit	diameter thread	width inside	length inside	diameter	length	thickness base	width outside	diameter base	diameter base	length inside	hex key	torque value	weight each
t	a mm	b mm	c mm	d mm	e mm	f mm	g mm	h mm	i mm	j mm	mm	Nm	kg
0.4	M8 x 1.25	35	41	13	52	35	68	34	38	43	6	6.5	0.46
0.4	M8 x 1.25	35	41	13	92	35	68	34	38	43	6	6.5	0.47
0.7	M10 x 1.5	35	39	13	62	37	68	34	38	43	8	13	0.47
0.7	M10 x 1.5	35	39	13	125	37	68	34	38	43	8	13	0.5
1	M12 x 1.75	35	36	13	62	39	68	34	38	43	10	22	0.49
1	M12 x 1.75	35	36	13	125	39	68	34	38	43	10	22	0.53
1.6	M16 x 2.0	35	42	13	92	43	68	34	38	52	14	55	0.6
1.6	M16 x 2.0	35	42	13	172	43	68	34	38	52	14	55	0.71
2.5	M20 x 2.5	35	38	13	112	47	68	34	38	52	17	110	0.75
2.5	M20 x 2.5	35	38	13	172	47	68	34	38	52	17	110	0.87
4	M24 x 3.0	53	55	20	112	71	105	49	56	71	19	190	2.16
4	M24 x 3.0	53	55	20	172	71	105	49	56	71	19	190	2.33
5	M27 x 3.0	53	61	20	90	65	105	49	56	71	19	280	2.2
6.3	M30 x 3.5	53	61	20	90	65	105	49	56	71	19	380	2.27
6.3	M30 x 3.5	53	61	20	240	65	105	49	56	71	19	380	3.05
10	M36 x 4.0	71	87	30	110	84	146	68	77	98	19	600	5.72
12.5	M42 x 4.5	71	87	30	120	84	146	68	77	98	19	1000	6.07



Green Pin® Small Lifting Eye GR8

Grade 8 small lifting eye

- **Material:** alloy steel, grade 8, quenched and tempered
- **Safety factor:** MBL equals 4 x WLL
- **Finish:** painted red or white
- **Temperature range:** -40°C up to +200°C
- **Certification:** 2.1 2.2 MPI^b CE



OL

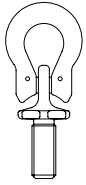
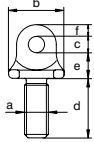

working load limit	diameter thread	diameter base	diameter eye inside	length	thickness base	width	can be combined with	weight each
t	a mm	b mm	c mm	d mm	e mm	f mm		kg
0.5	M8 x 1.25	28	8	30	13	6	GPXLC05, GPXLC0, GPCO5, GPCO6, GPMP5, GPMP6, GPCSC5, GPCSC6	0.05
0.9	M10 x 1.50	28	8	30	13	6		0.05
1.25	M12 x 1.75	28	8	30	13	6		0.06
1.5	M14 x 2.00	32	9	46	16	10	GPXLC1, GPCO7/8, GPMP7/8, GPCSC7/8	0.12
1.9	M16 x 2.00	32	9	46	16	10		0.14
2.25	M18 x 2.50	32	9	46	16	10		0.15
3.12	M20 x 2.50	41	13	56	19	11	GPXLC2, GPCO10, GPMP10, GPCSC10	0.25
3.8	M22 x 2.50	41	13	56	19	11		0.28
5	M24 x 3.00	54	16	68	28	12	GPXLC3, GPCO13, GPMP13, GPCSC13	0.53
6.25	M27 x 3.00	54	16	68	28	12		0.58
8	M30 x 3.50	60	20	92	33	13	GPXLC4, GPCO16, GPMP16, GPCSC16	0.94
9	M33 x 3.50	60	20	92	33	13		1.03
10	M36 x 4.00	60	20	92	33	13		1.12
12.5	M39 x 4.00	75	24	105	39	19	GPXLC5, GPCO18/20, GPMP18/20, GPCSC18/20	1.9
15	M42 x 4.50	75	24	105	39	19		2.02



Green Pin® Weld-On Transport Ring

Weld-on transport ring



PAS

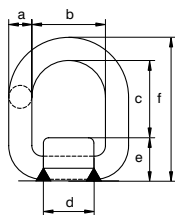

- **Material:** base: mild steel, ring: alloy steel, grade 8, quenched and tempered
- **Safety factor:** MBL equals 4 x WLL
- **Finish:** painted red or white
- **Temperature range:** -40°C up to +200°C
- **Certification:** 2.1 2.2 3.1 CE
- **Note:** welding must be done in accordance with DIN 5817 resp. 15429, by a qualified welder according to EN 287-1

working load limit	diameter	width inside	length inside	length base	height base	length	weight each
t	a mm	b mm	c mm	d mm	e mm	f mm	kg
1.2	13	40	42	35	28	83	0.4
3.2	18	45	48	42	33	99	0.77
5.4	22	55	57	49	42	121	1.42
8.2	26	70	67	64	50	143	2.5
12.8	28	85	90	78	55	173	3.7
15.5	34	99	93	90	63	190	5.67



E-8140

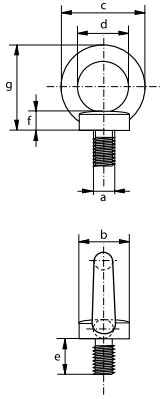

Eye bolts, generally to DIN 580

Generally to DIN 580

- **Material:** carbon steel, C15
- **Safety factor:** MBL equals 6 x WLL
- **Standard:** generally to DIN 580
- **Finish:** electro-galvanized
- **Certification:** 2.1 2.2 CE

working load limit	diameter thread	diameter base	diameter eye outside	diameter eye inside	length	thickness base	height	weight per 100 pcs
t	a mm	b mm	c mm	d mm	e mm	f mm	g mm	kg
0.07	M 6 x 1.00	20	36	20	13	6	36	5.1
0.14	M 8 x 1.25	20	36	20	13	6	36	5.5
0.23	M 10 x 1.50	25	45	25	17	8	45	10.3
0.34	M 12 x 1.75	30	54	30	20.5	10	53	16.9
0.49	M 14 x 2.00	35	63	35	27	12	60	29.9
0.7	M 16 x 2.00	35	63	35	27	12	62	30.7
0.9	M 18 x 2.50	40	72	40	30	14	71	42.8
1.2	M 20 x 2.50	40	72	40	30	14	71	42.4
1.5	M 22 x 2.50	45	81	45	39	14	80	62.8
1.8	M 24 x 3.00	50	90	50	36	18	90	90.8
2.5	M 27 x 3.00	50	90	50	39	18	90	88.3
3.2	M 30 x 3.50	65	108	60	45	22	109	159
4.3	M 33 x 3.50	65	108	60	45	22	110	167
4.6	M 36 x 4.00	75	126	70	54	26	128	235
6.1	M 39 x 4.00	75	126	70	54	26	130	266
6.3	M 42 x 4.50	85	144	80	63	30	147	403
8	M 45 x 4.50	85	144	80	63	35	150	521
8.6	M 48 x 5.00	100	166	90	68	35	168	632
11.5	M 56 x 5.50	110	184	100	78	38	187	879
16	M 64 x 6.00	120	206	110	90	42	208	1240
20	M 72 x 6.00	150	260	140	100	50	260	2293
28	M 80 x 6.00	170	296	160	112	55	298	3200
40	M 100 x 6.00	190	330	180	130	60	330	4800

C

Eye nuts, generally to DIN 582

Generally to DIN 582



- **Material:** carbon steel, C15
- **Safety factor:** MBL equals 6 x WLL
- **Standard:** generally to DIN 582
- **Finish:** electro-galvanized
- **Certification:** 2.1 2.2 CE

E-8142

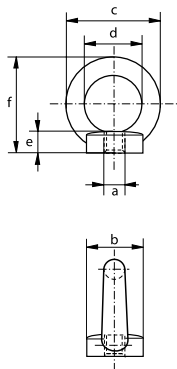

working load limit	diameter thread	diameter base	diameter eye outside	diameter eye inside	thickness base	height	weight per 100 pcs
t	a mm	b mm	c mm	d mm	e mm	f mm	kg
0.07	M 6 x 1.00	20	36	20	8.5	36	5.1
0.14	M 8 x 1.25	20	36	20	8.5	36	5.2
0.23	M 10 x 1.50	25	45	25	10	45	9.4
0.34	M 12 x 1.75	30	54	30	11	53	16
0.49	M 14 x 2.00	35	63	35	13	60	25.5
0.7	M 16 x 2.00	35	63	35	13	62	24
0.9	M 18 x 2.50	40	72	40	16	71	36
1.2	M 20 x 2.50	40	72	40	16	71	35.2
1.5	M 22 x 2.50	45	81	45	18	80	51.7
1.8	M 24 x 3.00	50	90	50	20	90	75.4
2.5	M 27 x 3.00	50	90	50	20	90	102
3.2	M 30 x 3.50	65	108	60	25	109	125
4.3	M 33 x 3.50	65	108	60	25	110	131
4.6	M 36 x 4.00	75	126	70	30	128	208
6.1	M 39 x 4.00	75	126	70	30	130	210
6.3	M 42 x 4.50	85	144	80	35	147	305
8	M 45 x 4.50	85	144	80	35	150	407
8.6	M 48 x 5.00	100	166	90	40	168	502
8.6	M 52 x 5.00	110	184	100	45	187	830
11.5	M 56 x 5.50	110	184	100	45	187	669
16	M 64 x 6.00	120	206	110	50	208	930
21	M 72 x 6.00	150	260	140	60	260	1500

LOADBINDERS



Applications

Green Pin® loadbinders are used for easy and efficient tightening of chain in lashing applications.

Range

Green Pin® offers three types of loadbinders for use with steel chain: two ratchet types and a lever type. Loadbinders are available for various steel chain sizes, ranging from 8 up to 16 mm, and for fibre chain. The ratchet types can be supplied with two hooks or two eyes as end fittings. A Green Pin Tycan® ratchet loadbinder (grade 10) is also available, for use with Green Pin Tycan® Lashing Chain.

Design

Green Pin® loadbinders are designed with an ergonomic, easy-to-use handle for simple, single-hand use, and are manufactured from drop forged or cast steel. One ratchet type is equipped with standard chain eye grab hooks, the other type has an improved version of these hooks to reduce chain wear substantially. It is also fitted with a pin to keep the chain in place. The latter type is designed to meet requirements of standard EN 12195-3.

Each loadbinder is generally marked with:

- Lashing Capacity - e.g. 10 t
- minimum breaking load - e.g. 21.2 t
- manufacturer's symbol - e.g. GP
- chain diameter in mm and inches - e.g. 13mm and 1/2"
- traceability code - e.g. A1
- warning - not for lifting or hoisting applications

Finish

Green Pin® loadbinders are painted either red, green or blue.

Certification

Specific details of certificate availability can be found on each product page. Please verify your certification requirements at the time of order.

Instructions for use

Loadbinders should be inspected before use to ensure that:

- all markings are legible;
- a loadbinder with the correct Lashing Capacity has been selected. For further details we refer to EN 12195-3, standard for Lashing Chains;
- loadbinders should never be used for lifting or hoisting applications;
- the loadbinder should never be side loaded, since loadbinders are suitable for in-line use only;
- the handle or any other locking system cannot vibrate out of position;
- the loadbinder must be hooked to the chain in such a way that you can operate the loadbinder whilst standing on the ground;
- never use a loadbinder while standing on the load;
- always keep yourself out of the path of the moving handle;
- if the handle of the lever type loadbinder cannot reach the correct locked position, never use a cheater pipe. In that case a ratchet type loadbinder must be used;
- in the locked position of a lever type loadbinder the bottom side of the loadbinder should touch the chain link. In this position secure the handle to the chain using the loose end of the chain or a piece of rope or soft wire;
- if the handle of a lever type loadbinder is released by hand, make sure you use an open hand under the handle and push upward. Do not close your hand around the handle. Move the handle with caution since it may whip as it comes free;
- loadbinders are free from nicks, gouges and cracks;
- loadbinders may not be heat treated as this may affect their Lashing Capacity;
- never modify, repair or reshape a loadbinder by machining, welding, heating or bending as this may affect the Lashing Capacity;
- the loadbinder is used with the correct chain type/size.

Loadbinders must be regularly inspected in accordance with the safety standards given in the country of use. This is required because the products in use may be affected by wear, misuse, overloading etc. which may lead to deformation and alteration of the material structure. Inspection should take place at least every six months and more frequently when the loadbinders are used in severe operating conditions. Regularly lubricate all moving parts of a loadbinder to extend product life and reduce wear.



Green Pin® Ratchet Loadbinder HK EN 12195-3

Ratchet type loadbinder with hooks according to EN 12195-3

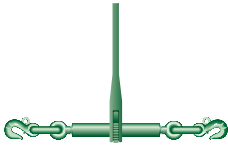

- **Material:** drop forged, grade 8
- **Safety factor:** MBL equals 2 x Lashing Capacity
- **Standard:** EN 12195-3
- **Finish:** painted red
- **Certification:** 2.1 2.2
- **Note:** Stf = 3000 daN

P-7170

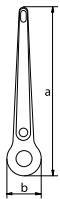
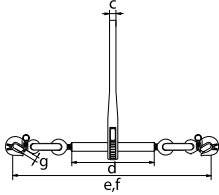

chain size	length handle	diameter	thickness	length barrel	length open position	length closed position	width	take-up	lashing capacity	proof load	minimum breaking load	weight each
mm	a	b	c	d	e	f	g	mm	t	t	t	kg
8	387	65	15	255	735	575	11	160	4	5	8	4.9
10	387	65	15	255	760	595	13	165	6.3	7.9	12.6	5.4
13	387	65	15	260	840	690	16	150	10	12.5	21.2	7.7
16	387	65	15	260	840	690	19	150	16	20	32.2	10.2

In inch

chain size	length handle	diameter	thickness	length barrel	length open position	length closed position	width	take-up	lashing capacity	proof load	minimum breaking load	weight each
inch	a	b	c	d	e	f	g	inch	t	t	t	lbs
$\frac{5}{16}$	15 $\frac{1}{4}$	2 $\frac{9}{16}$	$\frac{19}{32}$	10 $\frac{1}{32}$	28 $\frac{29}{32}$	22 $\frac{5}{8}$	$\frac{7}{16}$	6 $\frac{9}{32}$	4	5	8	10.80
$\frac{3}{8}$	15 $\frac{1}{4}$	2 $\frac{9}{16}$	$\frac{19}{32}$	10 $\frac{1}{32}$	29 $\frac{29}{32}$	23 $\frac{7}{16}$	$\frac{1}{2}$	6 $\frac{1}{2}$	6.3	7.9	12.6	11.90
$\frac{1}{2}$	15 $\frac{1}{4}$	2 $\frac{9}{16}$	$\frac{19}{32}$	10 $\frac{1}{4}$	33 $\frac{3}{32}$	27 $\frac{5}{32}$	$\frac{5}{8}$	5 $\frac{29}{32}$	10	12.5	21.2	16.98
$\frac{5}{8}$	15 $\frac{1}{4}$	2 $\frac{9}{16}$	$\frac{19}{32}$	10 $\frac{1}{4}$	33 $\frac{3}{32}$	27 $\frac{5}{32}$	$\frac{3}{4}$	5 $\frac{29}{32}$	16	20	32.2	22.5

Green Pin® Ratchet Loadbinder EN 12195-3

Ratchet type loadbinder without hooks according to EN 12195-3

- **Material:** drop forged, grade 8
- **Safety factor:** MBL equals 2 x Lashing Capacity
- **Standard:** EN 12195-3
- **Finish:** painted red
- **Certification:** 2.1 2.2
- **Note:** Stf = 3000 daN

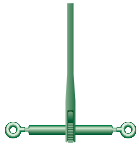

P-7190

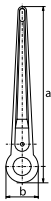
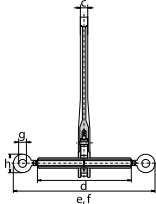

chain size	length handle	diameter	thickness	length barrel	length open position	length closed position	diameter eye inside	diameter eye outside	take-up	lashing capacity	proof load	minimum breaking load	weight each
mm	a mm	b mm	c mm	d mm	e mm	f mm	g mm	h mm	mm	t	t	t	kg
8	387	65	15	255	534	374	18	50	160	4	5	8	3.3
10	387	65	15	255	543	379	20	55	164	6.3	7.9	12.6	3.4
13	387	65	15	260	564	414	26	66	150	10	12.5	21.2	4
16	387	65	15	260	564	420	30	71	144	16	20	32.2	4.1

In inch

chain size	length handle	diameter	thickness	length barrel	length open position	length closed position	diameter eye inside	diameter eye outside	take-up	lashing capacity	proof load	minimum breaking load	weight each
inch	a inch	b inch	c inch	d inch	e inch	f inch	g inch	h inch	inch	t	t	t	lbs
$\frac{5}{16}$	15 $\frac{1}{4}$	2 $\frac{9}{16}$	$\frac{19}{32}$	10 $\frac{1}{32}$	21 $\frac{1}{32}$	14 $\frac{23}{32}$	$\frac{23}{32}$	1 $\frac{31}{32}$	6 $\frac{9}{32}$	4	5	8	7.28
$\frac{3}{8}$	15 $\frac{1}{4}$	2 $\frac{9}{16}$	$\frac{19}{32}$	10 $\frac{1}{32}$	21 $\frac{3}{8}$	14 $\frac{29}{32}$	$\frac{25}{32}$	2 $\frac{5}{32}$	6 $\frac{7}{16}$	6.3	7.9	12.6	7.50
$\frac{1}{2}$	15 $\frac{1}{4}$	2 $\frac{9}{16}$	$\frac{19}{32}$	10 $\frac{1}{4}$	22 $\frac{3}{16}$	16 $\frac{5}{16}$	1 $\frac{1}{32}$	2 $\frac{19}{32}$	5 $\frac{29}{32}$	10	12.5	21.2	8.82
$\frac{5}{8}$	15 $\frac{1}{4}$	2 $\frac{9}{16}$	$\frac{19}{32}$	10 $\frac{1}{4}$	22 $\frac{3}{16}$	16 $\frac{9}{16}$	1 $\frac{3}{16}$	2 $\frac{25}{32}$	5 $\frac{11}{16}$	16	20	32.2	9.04



Green Pin® Ratchet Loadbinder HK

Ratchet type loadbinder with hooks

- **Material:** drop forged/cast steel
- **Safety factor:** MBL equals 3.5 x Lashing Capacity
- **Finish:** painted red or green
- **Certification:** 2.1 2.2

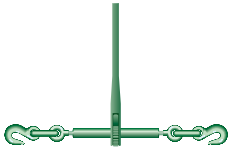

P-7130

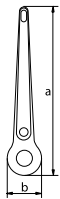
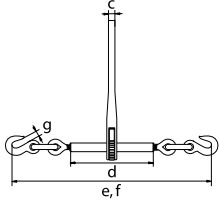

chain size	length handle	diameter	thickness	length barrel	length open position	length closed position	width	take-up	lashing capacity	proof load	minimum breaking load	weight each
mm	a mm	b mm	c mm	d mm	e mm	f mm	g mm	mm	t	t	t	kg
8 - 10	385	65	15	255	735	575	12	160	2.45	4.9	8.62	4.32
10 - 13	385	65	15	255	760	595	16	165	4.175	8.35	14.97	5.73
13 - 16	385	65	15	260	840	690	18	150	5.9	11.8	20.865	7.85

In inch

chain size	length handle	diameter	thickness	length barrel	length open position	length closed position	width	take-up	lashing capacity	proof load	minimum breaking load	weight each
inch	a inch	b inch	c inch	d inch	e inch	f inch	g inch	inch	t	t	t	lbs
$\frac{5}{16} - \frac{3}{8}$	$15 \frac{5}{32}$	$2 \frac{9}{16}$	$\frac{19}{32}$	$10 \frac{1}{32}$	$28 \frac{29}{32}$	$22 \frac{5}{8}$	$\frac{15}{32}$	$6 \frac{9}{32}$	2.45	4.9	8.62	9.52
$\frac{3}{8} - \frac{1}{2}$	$15 \frac{5}{32}$	$2 \frac{9}{16}$	$\frac{19}{32}$	$10 \frac{1}{32}$	$29 \frac{29}{32}$	$23 \frac{7}{16}$	$\frac{5}{8}$	$6 \frac{1}{2}$	4.175	8.35	14.97	12.63
$\frac{1}{2} - \frac{5}{8}$	$15 \frac{5}{32}$	$2 \frac{9}{16}$	$\frac{19}{32}$	$10 \frac{1}{4}$	$33 \frac{3}{32}$	$27 \frac{5}{32}$	$\frac{23}{32}$	$5 \frac{29}{32}$	5.9	11.8	20.865	17.31



Green Pin® Ratchet Loadbinder

Ratchet type loadbinder without hooks

- **Material:** drop forged/cast steel
- **Safety factor:** MBL equals 3.5 x Lashing Capacity
- **Finish:** painted red or green
- **Certification:** 2.1 2.2

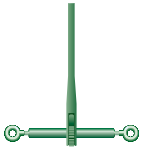

P-7150

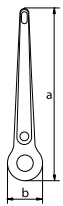
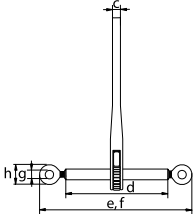

chain size	length handle	diameter	thickness	length barrel	length open position	length closed position	diameter eye inside	diameter eye outside	take-up	lashing capacity	proof load	minimum breaking load	weight each
mm	a mm	b mm	c mm	d mm	e mm	f mm	g mm	h mm	mm	t	t	t	kg
8 - 10	385	65	15	255	534	374	18	50	160	2.45	4.9	8.62	3.27
10 - 13	385	65	15	255	543	379	20	55	164	4.175	8.35	14.97	4.75
13 - 16	385	65	15	260	564	412	26	66	152	5.9	11.8	20.865	6.65

In inch

chain size	length handle	diameter	thickness	length barrel	length open position	length closed position	diameter eye inside	diameter eye outside	take-up	lashing capacity	proof load	minimum breaking load	weight each
inch	a inch	b inch	c inch	d inch	e inch	f inch	g inch	h inch	inch	t	t	t	lbs
$\frac{5}{16} - \frac{3}{8}$	$15 \frac{5}{32}$	$2 \frac{9}{16}$	$\frac{19}{32}$	$10 \frac{1}{32}$	$21 \frac{1}{32}$	$14 \frac{23}{32}$	$\frac{23}{32}$	$1 \frac{31}{32}$	$6 \frac{9}{32}$	2.45	4.9	8.62	7.21
$\frac{3}{8} - \frac{1}{2}$	$15 \frac{5}{32}$	$2 \frac{9}{16}$	$\frac{19}{32}$	$10 \frac{1}{32}$	$21 \frac{3}{8}$	$14 \frac{29}{32}$	$\frac{25}{32}$	$2 \frac{5}{32}$	$6 \frac{7}{16}$	4.175	8.35	14.97	10.47
$\frac{1}{2} - \frac{5}{8}$	$15 \frac{5}{32}$	$2 \frac{9}{16}$	$\frac{19}{32}$	$10 \frac{1}{4}$	$22 \frac{3}{16}$	$16 \frac{1}{4}$	$1 \frac{1}{32}$	$2 \frac{19}{32}$	$5 \frac{31}{32}$	5.9	11.8	20.865	14.66



Green Pin® Lever Loadbinder HK

Lever type loadbinder with hooks



- **Material:** drop forged/cast steel
- **Safety factor:** MBL equals 3.5 x Lashing Capacity
- **Finish:** painted green
- **Certification:** 2.1 2.2

P-7110

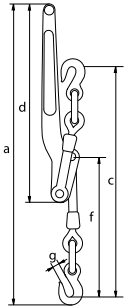
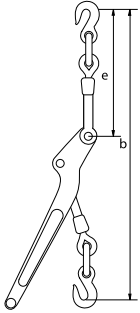

chain size	length	length open position	length closed position	length handle	length	length	width	take-up	lashing capacity	proof load	minimum breaking load	weight each
mm	a mm	b mm	c mm	d mm	e mm	f mm	g mm	mm	t	t	t	kg
8 - 10	610	592	488	408	287	287	12	104	2.45	4.9	8.62	2.81
10 - 13	768	680	550	458	325	325	16	130	4.175	8.35	14.97	5.08

In inch

chain size	length	length open position	length closed position	length handle	length	length	width	take-up	lashing capacity	proof load	minimum breaking load	weight each
inch	a inch	b inch	c inch	d inch	e inch	f inch	g inch	inch	t	t	t	lbs
$\frac{5}{16} - \frac{3}{8}$	24	$23 \frac{5}{16}$	$19 \frac{1}{4}$	$16 \frac{3}{32}$	$11 \frac{5}{16}$	$11 \frac{5}{16}$	$\frac{15}{32}$	$4 \frac{3}{32}$	2.45	4.9	8.62	6.19
$\frac{3}{8} - \frac{1}{2}$	$30 \frac{3}{16}$	$26 \frac{3}{4}$	$21 \frac{11}{16}$	$18 \frac{1}{32}$	$12 \frac{25}{32}$	$12 \frac{25}{32}$	$\frac{5}{8}$	$5 \frac{1}{8}$	4.175	8.35	14.97	5.08



Green Pin TyCan® Ratchet Loadbinder GR10

Grade 10 ratchet type loadbinder

- **Material:** drop forged, grade 10
- **Safety factor:** MBL equals 2x Lashing Capacity
- **Standard:** EN 12195-3
- **Finish:** painted blue
- **Certification:** 2.1 2.2
- **Compatible with:** FCHLASH1525 (G-4151; 4.75t, G-4153; 4.75t or UCRCT; 10t are necessary to connect the loadbinder with FCHLASH1525)
- **Note:** Stf = 3000daN

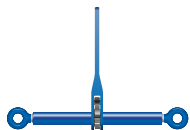

P-7180

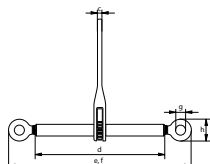

chain size	length handle	diameter	thickness	length barrel	length open position	length closed position	diameter eye inside	diameter eye outside	take-up	lashing capacity	proof load	minimum breaking load	weight each
mm	a	b	c	d	e	f	g	h	mm	t	t	t	kg
15x25	387	65	15	410	864	564	30	71	300	10	12.5	21.2	5.85

In inch

chain size	length handle	diameter	thickness	length barrel	length open position	length closed position	diameter eye inside	diameter eye outside	take-up	lashing capacity	proof load	minimum breaking load	weight each
inch	a	b	c	d	e	f	g	h	inch	t	t	t	lbs
$19/32 \times 1$	$15 \frac{1}{4}$	$2 \frac{9}{16}$	$\frac{19}{32}$	$16 \frac{5}{32}$	$34 \frac{1}{32}$	$22 \frac{7}{32}$	$1 \frac{3}{16}$	$2 \frac{25}{32}$	$11 \frac{13}{16}$	10	12.5	21.2	12.9

CHAIN



Applications

Green Pin® grade 8 and grade 10 steel chain can be used for lifting. Green Pin Tycan® Chain is available as lifting and lashing chain. Short link and long link commercial grade 3 chain is for general purpose use and may not be used for lifting purposes.

Range

Green Pin® supplies a wide range of chain. The range of grade 8 chain extends from 6 mm to 32 mm (1/4" to 1 1/4"). The range of grade 10 chain extends from 6 mm to 20 mm (7/32" to 3/4"). Green Pin Tycan® Lifting and Lashing Chain is available in sizes 11x15 mm, 11x20 mm, 15x25 mm and 13x30 mm. To complement the Green Pin® assortment, Van Beest also supplies chain to DIN 763 and DIN 766 ranging from 3 up to 20 mm.

Design

Grade 8 chain conforms to EN 818-2 and is made from alloy steel. Grade 10 chain is made from alloy steel as well. Green Pin Tycan® Chain is made from 100% Dyneema® Fibre. Other chain supplied by Green Pin® generally follows DIN 763 (for long link chain) or DIN 766 (for short link chain). It is made of grade 3 mild steel. These types of chain are not suitable for lifting purposes.

Finish

Both grade 8 and grade 10 steel chain are painted. Steel chain (DIN 763 and DIN 766) is available in self coloured, electro-galvanized or hot dipped galvanized condition.

Instructions for use

DIN 766 and DIN 763 chain should be inspected before use to ensure that it is free from nicks, gouges and cracks.

Also:

- DIN 766 and DIN 763 chain may not be used for lifting purposes;
- the chain is designed for in-line use only;
- the chain may not be heat treated, as this may affect performance.

Grade 8 and grade 10 chain should be inspected before use to ensure that:

- the chain is free from nicks, gouges and cracks;
- the item is not distorted or unduly worn.

Also:

- the chain may not be heat treated, as this may affect the performance;
- all components of the sling must be of the same steel grade;
- items should be used for in-line lifting only.

INFO

For complete Green Pin Tycan® Lifting and Lashing Chain instructions, please refer to the user manuals in the FAQ section on our website.

Chain must be regularly inspected in accordance with the safety standards given in the country of use. This is required because the products in use may be affected by issues such as wear, misuse, and overloading, which may lead to deformation and alteration of the material structure. Inspection should take place at least every six months and more frequently when the chain is used in severe operating conditions.



Green Pin® Lifting Chain EN818-2 GR8

Grade 8 lifting chain

- **Material:** alloy steel, grade 8, quenched and tempered
- **Safety factor:** MBL equals 4 x WLL
- **Standard :** EN 818-2
- **Finish:** painted black
- **Temperature range:** -40°C up to 200°C
- **Certification:** 2.1 2.2 3.1 MTC^b DGVV



CHAIN

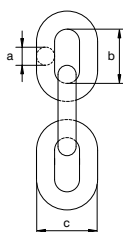

diameter		working load limit	length inside	width outside	links per meter	length per drum	weight per meter
a							
mm	inch	mm	mm	m	kg		
6	7/32	1.12	18	22	55.56	600	0.78
7	1/4	1.5	21	26	47.62	500	1.14
8	5/16	2	24	30	41.67	350	1.5
10	3/8	3.15	30	36	33.33	250	2.27
13	1/2	5.3	39	47	25.64	150	3.74
16	5/8	8	48	58	20.83	100	5.54
20	3/4	12.5	60	72	16.67	60	8.94
22	7/8	15	66	79	15.15	50	11.57
26	1	21.2	78	93	12.82	30	15.26
32	1 1/4	31.5	96	112	10.42	50	22.61



Green Pin® Lifting Chain GR10

Grade 10 lifting chain

- **Material:** alloy steel, grade 10, quenched and tempered
- **Safety factor:** MBL equals 4 x WLL
- **Finish:** painted blue
- **Temperature range:** -40°C up to 200°C
- **Certification:** 2.1 2.2 3.1 MTC^b



UCHAIN

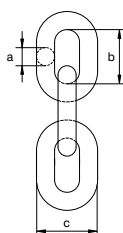

diameter		working load limit	length inside	width outside	links per meter	length per drum	weight per meter
a							
mm	inch	mm	mm	m	kg		
6	7/32	1.4	18	22	55.56	200	0.8
8	5/16	2.5	24	30	41.67	200	1.5
10	3/8	4	30	36	33.33	200	2.3
13	1/2	6.7	39	48	25.64	100	3.9
16	5/8	10	48	58	20.83	100	5.8
20	3/4	16	60	72	16.67	50	8.9



Green Pin Tycan® Lifting Chain

Lifting chain made from Dyneema®

- **Material:** made from 100% Dyneema®; layers of webbing in a Mobius twist with stitching on each side
- **Safety factor:** MBL equals 4 x WLL
- **Temperature range:** -40°C to +70°C
- **Certification:** 2.1 2.2 MTC^b DNV GL TQ CE



FCHLIFT

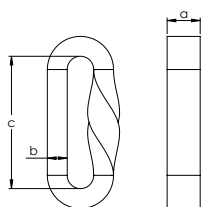

link size	working load limit	width link	thickness link	length inside	links per meter	elongation at MBL	weight per meter	layers
mm	t	a mm	b mm	c mm		%	kg	
11x15	2.6	15	11	100	10	5	0.32	6
11x20	4	20	11	100	10	5	0.47	6
15x25	5	25	15	100	10	5	0.58	8
13x30	6.8	30	13	125	8	5	0.75	7

In inch

link size	working load limit	width link	thickness link	length inside	links per meter	elongation at MBL	weight per meter	layers
inch	t	a inch	b inch	c inch		%	lbs	
7/16 X 19/32	2.6	19/32	7/16	4	10	5	0.70	6
7/16 X 25/32	4	25/32	7/16	4	10	5	1.04	6
19/32 X 1	5	1	19/32	4	10	5	1.28	8
1/2 X 1 3/16	6.8	1 3/16	1/2	4 59/64	8	5	1.65	7

INFO



Green Pin Tycan® Lashing Chain

Lashing chain made from Dyneema®

- **Material:** made from 100% Dyneema®; layers of webbing in a Mobius twist with stitching on each side
- **Safety Factor:** MBL equals 2 x Lashing Capacity
- **Temperature range:** -60°C to +70°C
- **Certification:** 2.1 2.2 MTC^b DNV GL TQ CE



FCHLASH

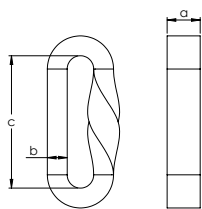

link size	lashing capacity	width link	thickness link	length inside	links per meter	elongation at MBL	weight per meter	layers
mm	t	a mm	b mm	c mm		%	kg	
15x25	10	25	15	100	10	5	0.58	8

In inch

link size	lashing capacity	width link	thickness link	length inside	links per meter	elongation at MBL	weight per meter	layers
inch	t	a inch	b inch	c inch		%	lbs	
19/32 X 1	10	1	19/32	4	10	5	1.28	8

INFO

C

Short link chain

Generally to DIN 766 and DIN 5685-3, commercial quality

- **Material:** mild steel, grade 3
- **Standard:** generally to DIN 766 and DIN 5685-3
- **Finish:** electro-galvanized or hot dipped galvanized
- **Certification:** 2.1
- **Note:** not to be used for lifting applications!

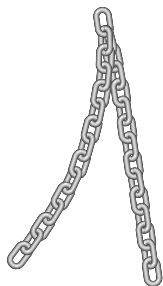

E-7661
G-7662

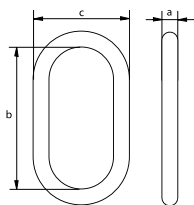

diameter	length inside	length outside	weight per meter
a mm	b mm	c mm	kg
3	16	11	0.17
4	16	14	0.32
5	18.5	17	0.5
6	18.5	20	0.75
7	22	23	1
8	24	26	1.35
9	27	30	1.8
10	28	34	2.25
11	31	36	2.7
13	36	44	3.8
16	45	54	5.8
18	50	60	7.3

C

Long link chain

Generally to DIN 763 and DIN 5685-1, commercial quality

- **Material:** mild steel, grade 3
- **Standard:** generally to DIN 763 and DIN 5685-1
- **Finish:** electro-galvanized or hot dipped galvanized
- **Certification:** 2.1
- **Note:** not to be used for lifting applications!

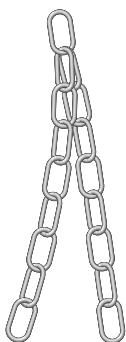

E-7631
G-7632

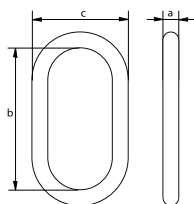

diameter	length inside	length outside	weight per meter
a mm	b mm	c mm	kg
3	26	13	0.14
4	32	16	0.27
5	36	20	0.43
6	42	24	0.63
7	48	28	0.86
8	54	32	1.10
10	66	40	1.75
13	82	50	2.95
16	100	60	4.45

SHORTENING CLUTCHES



Applications

Grade 8 shortening clutches are designed to be used in the manufacturing of grade 8 chain slings. Grade 10 shortening clutches are designed to be used in the manufacturing of grade 10 slings.

Range

Green Pin® offers a range of grade 8 and grade 10 shortening clutches. The range extends from 6 mm to 20 mm ($7/32''$ to $3/4''$).

Design

Green Pin® Grade 8 and Grade 10 shortening clutches are manufactured from drop forged alloy steel.

The shortening components are generally marked with:

- manufacturer's symbol - GP
- chain diameter in mm and/or inch - e.g. 13 and/or $1/2''$
- traceability code - e.g. HA
- steel grade - 8 or 10
- item code - e.g. GVC
- origin - France

Finish

Green Pin® shortening clutches are painted. Grade 8 products were painted yellow or red under the Excel® brand. However, grade 8 products under the Green Pin® brand will be painted white. Grade 10 products are painted blue and will remain so.

Instructions for use

All grade 8 and grade 10 components should be inspected before use to ensure that:

- all markings are legible;
- items with the correct WLL have been selected. For further details, refer to the EN818 standard for chain slings;
- items are not distorted or unduly worn;
- all items are free from nicks, gouges, cracks and corrosion.

Also:

- all components of the sling must be of the same steel grade;
- items should be used for in-line lifting only;
- the bolt, nut or any other locking system must not vibrate out of position;
- items may not be heat treated as this may affect their WLL;
- never modify, repair or reshape an item by machining, welding, heating or bending as this may affect the WLL.



Green Pin® Shortening Clutch EN 1677-1 GR8

Grade 8 shortening clutch EN 1677-1

- **Material:** alloy steel, grade 8, quenched and tempered
- **Safety factor:** MBL equals 4 x WLL
- **Standard :** EN 1677-1 and DIN 5692
- **Finish:** painted yellow (J), red (R) or white
- **Temperature range:** -40°C up to +200°C
- **Certification:** 2.1 2.2 3.1 MPI[®]



GC

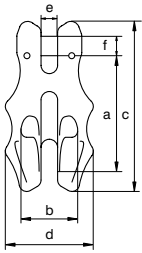

for chain diameter		working load limit	length	width inside	length	width outside	width	diameter pin	weight each
mm	inch	t	a mm	b mm	c mm	d mm	e mm	f mm	kg
6	7/32	1.12	51	23	75	42	7	8	0.22
7/8	1/4 - 5/16	2	67	30	94	50	9	9	0.41
10	3/8	3.2	79	38	116	63	12	13	0.82
13	1/2	5.4	103	49	149	79	15	16	1.67
16	5/8	8.2	128	60	184	99	19	20	3.1
18/20	3/4	12.8	154	75	215	124	23	24	4.02

INFO



Green Pin® Shortening Clutch with Lock EN 1677-1 GR8

Grade 8 shortening clutch with locking pin EN 1677-1

- **Material:** alloy steel, grade 8, quenched and tempered
- **Safety factor:** MBL equals 4 x WLL
- **Standard :** EN 1677-1 and DIN 5692
- **Finish:** painted yellow (J), red (R) or white
- **Temperature range:** -40°C up to +200°C
- **Certification:** 2.1 2.2 3.1 MPI[®]

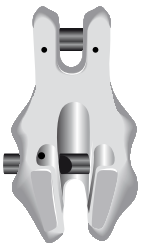

GCV

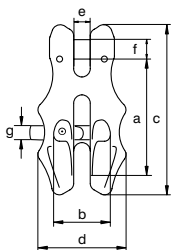

for chain diameter		working load limit	length	width inside	length	width outside	width	diameter pin	diameter pin	weight each
mm	inch	t	a mm	b mm	c mm	d mm	e mm	f mm	g mm	kg
6	7/32	1.12	51	23	75	42	7	8	7	0.22
8	1/4 - 5/16	2	67	30	94	50	9	9	8	0.41
10	3/8	3.2	79	38	116	63	12	13	12	0.82
13	1/2	5.4	103	49	149	79	15	16	16	1.67
16	5/8	8.2	128	60	184	99	19	20	20	3.1
20	3/4	12.8	154	75	215	124	23	24	20	4.02

INFO



Green Pin® Shortening Clutch with Double Lock EN 1677-1 GR8

Grade 8 shortening clutch with double locking pin EN 1677-1

- **Material:** alloy steel, grade 8, quenched and tempered
- **Safety factor:** MBL equals 4 x WLL
- **Standard :** EN 1677-1 and DIN 5692
- **Finish:** painted yellow (J), red (R) or white
- **Temperature range:** -40°C up to +200°C
- **Certification:** 2.1 2.2 3.1 MPI^b CE

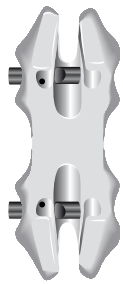

GDV

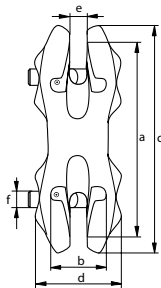

for chain diameter		working load limit	length	width inside	length	width outside	width	diameter pin	weight each
mm	inch		a mm	b mm	c mm	d mm	e mm	f mm	
6	7/32	1.12	99	23	120	42	7	7	0.49
8	5/16	2	112	30	140	50	9	8	0.77
13	1/2	5.4	178	49	208	79	15	16	2.85

INFO



Green Pin® Shortening Clutch GR10

Grade 10 shorting clutch with locking pin

- **Material:** alloy steel, grade 10, quenched and tempered
- **Safety factor:** MBL equals 4 x WLL
- **Finish:** painted blue
- **Temperature range:** -40°C up to +200°C
- **Certification:** 2.1 2.2 3.1 MPI^b



UGC

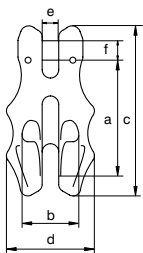

for chain diameter		working load limit	length	width inside	length	width outside	width	diameter pin	weight each
mm	inch		a mm	b mm	c mm	d mm	e mm	f mm	
6	7/32	1.4	51	23	75	42	7	8	0.23
8	5/16	2.6	67	30	94	50	9	10	0.45
10	3/8	4	79	38	116	63	12	13	0.9
13	1/2	6.8	103	49	149	79	15	16	1.8
16	5/8	10.3	128	60	184	99	19	20	3.1
20	3/4	16	154	75	215	124	23	24	4



Green Pin® Shortening Clutch with Lock GR10

Grade 10 shortening clutch with locking pin

- **Material:** alloy steel, grade 10, quenched and tempered
- **Safety factor:** MBL equals 4 x WLL
- **Finish:** painted blue
- **Temperature range:** -40°C up to +200°C
- **Certification:** 2.1 2.2 3.1 MPI[®]

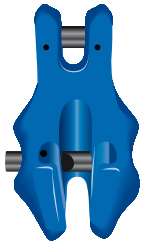

UGCV

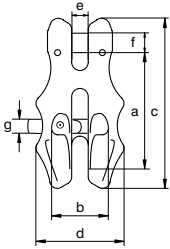

for chain diameter		working load limit	length	width inside	length	width outside	width	diameter pin	diameter pin	weight each
mm	inch		a mm	b mm	c mm	d mm	e mm	f mm	g mm	
6	7/32	1.4	51	23	75	42	7	8	7	0.23
8	5/16	2.6	67	30	94	50	9	10	8	0.44
10	3/8	4	79	38	116	63	12	13	12	0.76
13	1/2	6.8	103	49	149	79	15	16	16	1.67
16	5/8	10.3	128	60	184	99	19	20	20	3.1
20	3/4	16	154	75	215	124	23	24	20	4



Green Pin® Shortening Clutch with Double Lock GR10

Grade 10 shortening clutch with double locking pin

- **Material:** alloy steel, grade 10, quenched and tempered
- **Safety factor:** MBL equals 4 x WLL
- **Finish:** painted blue
- **Temperature range:** -40°C up to +200°C
- **Certification:** 2.1 2.2 3.1 MPI[®]



UGDC

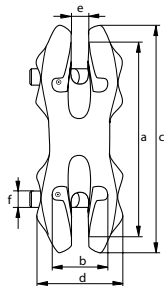

for chain diameter		working load limit	length	width inside	length	width outside	width	diameter pin	weight each
mm	inch		a mm	b mm	c mm	d mm	e mm	f mm	
6	7/32	1.4	99	23	120	42	7	7	0.49
8	5/16	2.6	112	30	140	50	9	8	0.77
13	1/2	6.7	178	49	208	79	15	16	2.85

LIFTING CLAMPS



Applications

Lifting Clamps are used for lifting and transportation of all kinds of steel plates and beams.

Range

Green Pin® offers a wide range of lifting clamps for horizontal and/or vertical lifting of steel plates and beams ranging from WLL 0.75 t up to 20 t. They can handle steel plates with a thickness up to 150 mm. Upon request other types of clamps can be manufactured.

Design

Four different designs have been developed:

- P-6615, for lifting and vertical transportation of steel plates;
- P-6635, for horizontal transportation of steel plates;
- P-6625, a universal type for transportation in all directions;
- P-6685, for transportation of steel beams.

All of these types are also available as BigMouth® versions, which have a larger opening.

All types of lifting clamps are generally marked with:

- Working Load Limit - e.g. 3000 kg
- manufacturer's identification symbol - Green Pin®
- type - 3 U
- jaw opening in mm - e.g. 35 mm
- serial number - e.g. E 12031976B64
- CE conformity code - CE

Finish

The lifting clamps are made of carbon and alloy steel and are painted.

Certification

Specific details of certificate availability can be found on each product page. Please verify your certification requirements at the time of order.

Instructions for use

Lifting clamps should be inspected before use to ensure that:

- all markings are legible;
- a clamp with the correct WLL has been selected;
- always make sure that the clamp is supporting the load correctly;
- the WLL should be applied in-line;
- overloads are not permitted;
- the locking lever or any other locking system cannot vibrate out of position;
- lifting clamps are free from nicks, gouges and cracks;
- clamps may not be heat treated as this may affect their WLL;
- never modify, repair or reshape a clamp by machining, welding, heating or bending as this may affect the WLL.

For more detailed instructions for use, we refer to the instructions in the FAQ section on our website:

PI-03-15 for Green Pin® Lifting Clamp H-Type (P-6635 and P-6636)

PI-03-16 for Green Pin® Lifting Clamp V-Type and U-Type (P-6615, P-6616, P-6625 and P-6626)

PI-03-17 for Green Pin® Beam Lifting Clamp H-Type (P-6685 and P-6686)

Lifting clamps must be regularly inspected in accordance with the safety standards given in the country of use. This is required because the products in use may be affected by wear, misuse, overloading etc. which may lead to deformation and alteration of the material structure. Inspection should take place at least every six months and more frequently when the clamps are used in severe operating conditions.

Lifting clamps P-6615 and P-6616

Full load may be applied up to a load direction angle of maximum 45°. Load reduction should be applied as per load direction angle and corresponding remaining percentage of the Working Load Limit. Do not side load the lifting eye.

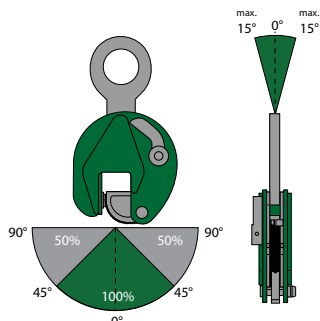

Lifting clamps P-6625 and P-6626

Full load may be applied up to a load direction angle of maximum 45°. Load reduction should be applied as per load direction angle and corresponding remaining percentage of the Working Load Limit. Do not side load the lifting eye.

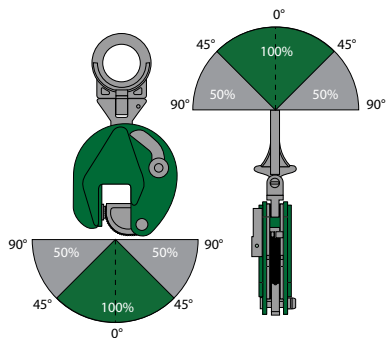

Lifting clamps P-6635 and P-6636, 100% WLL

Full load may be applied up to a load direction angle of maximum 30°. Do not use larger angles.

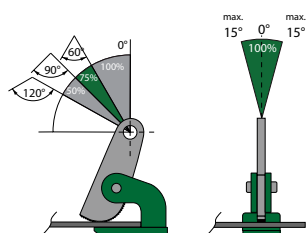

Lifting clamps P-6685 and P-6686, 100% WLL

Full load may be applied up to a load direction angle of maximum 15°. Do not use larger angles.

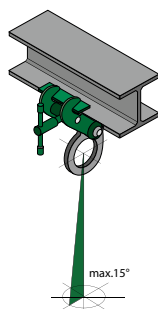



Green Pin® Lifting Clamp V-type

Plate clamp for lifting and vertical transportation

- **Material:** carbon and alloy steel
- **Safety factor:** MBL equals 5 x WLL
- **Standard:** generally to EN 13155, ASME B30.20-2010 and AS 4991
- **Finish:** painted
- **Temperature range:** -40°C up to +100°C
- **Certification:** 2.1 2.2 MTC[®] CE



P-6615

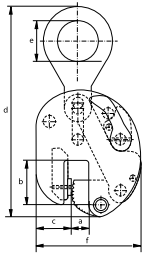

type	working load limit	width opening	length opening	width	length	diameter inside eye	width	thickness	thickness	weight each
	t	a mm	b mm	c mm	d mm	e mm	f mm	g mm	h mm	kg
0.75 V	0.75	0-13	47	37	202	30	100	37	10	1.7
1 V	1	0-25	56	37	263	45	141	47	15	3.5
2 V	2	0-35	78	56	336	64	183	56	16	7
3 V	3	0-35	78	56	336	64	336	56	16	7
4.5 V	4.5	0-45	85	60	425	70	228	78	20	16
6 V	6	0-50	114	82	490	75	259	78	20	21
7.5 V	7.5	0-55	111	70	522	75	267	86	20	26
9 V	9	0-55	111	70	522	75	267	86	20	27
12 V	12	0-52	148	100	617	85	295	94	44	37
15 V	15	0-76	209	136	810	86	373	106	49	70
20 V	20	0-80	250	153	933	100	563	140	66	149

INFO



Green Pin BigMouth® Lifting Clamp V-type

Plate clamp with enlarged opening for lifting and vertical transportation

- **Material:** carbon and alloy steel
- **Safety factor:** MBL equals 5 x WLL
- **Standard:** generally to EN 13155, ASME B30.20-2010 and AS 4991
- **Finish:** painted
- **Temperature range:** -40°C up to +100°C
- **Certification:** 2.1 2.2 MTC[®] CE



P-6616

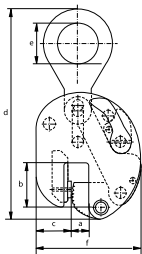

type	working load limit	width opening	length opening	width	length	diameter inside eye	width	thickness	thickness	weight each
	t	a mm	b mm	c mm	d mm	e mm	f mm	g mm	h mm	kg
6 VE	6	40-90	114	70	486	75	275	78	20	21
7.5 VE	7.5	50-100	111	70	524	75	312	86	20	26.5
9 VE	9	50-100	111	70	522	75	312	86	20	27.5
12 VE	12	50-100	152	100	615	85	344	94	44	41
15 VE	15	80-150	224	136	800	86	450	106	49	76
20 VE	20	80-150	249	153	924	100	640	140	66	160

INFO



Green Pin® Lifting Clamp U-type

Universal plate clamp for lifting and transportation in all directions

- **Material:** carbon and alloy steel
- **Safety factor:** MBL equals 5 x WLL
- **Standard:** generally to EN 13155, ASME B30.20-2010 and AS 4991
- **Finish:** painted
- **Temperature range:** -40°C up to +100°C
- **Certification:** 2.1 2.2 MTC[®] CE



P-6625

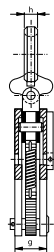
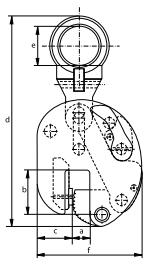

type	working load limit	width opening	length opening	width	length	diameter inside eye	width	thickness	thickness	weight each
	t	a mm	b mm	c mm	d mm	e mm	f mm	g mm	h mm	kg
0.75 U	0.75	0-13	47	37	203	30	100	37	10	1.8
2 U	2	0-35	78	56	372	70	183	56	16	8
3 U	3	0-35	78	56	372	70	183	56	16	8
6 U	6	0-50	114	82	527	78	259	78	32	24
7.5 U	7.5	0-55	111	70	560	78	267	86	32	28
9 U	9	0-55	111	70	560	78	267	86	32	29
12 U	12	0-52	148	100	648	85	295	94	48	41

INFO



Green Pin BigMouth® Lifting Clamp U-type

Universal plate clamp for transportation in all directions and with enlarged opening

- **Material:** carbon and alloy steel
- **Safety factor:** MBL equals 5 x WLL
- **Standard:** generally to EN 13155, ASME B30.20-2010 and AS 4991
- **Finish:** painted
- **Temperature range:** -40°C up to +100°C
- **Certification:** 2.1 2.2 MTC[®] CE



P-6626

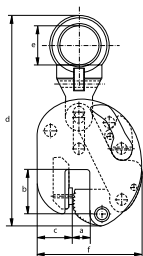

type	working load limit	width opening	length opening	width	length	diameter inside eye	width	thickness	thickness	weight each
	t	a mm	b mm	c mm	d mm	e mm	f mm	g mm	h mm	kg
6 UE	6	40-90	114	70	523	78	275	778	32	24
7.5 UE	7.5	50-100	111	70	560	78	312	86	32	30
9 UE	9	50-100	111	70	560	78	312	86	32	31
12 UE	12	50-100	152	100	644	85	344	94	48	45

INFO



Green Pin® Lifting Clamp H-Type

Plate clamp for horizontal transportation



P-6635

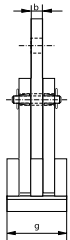
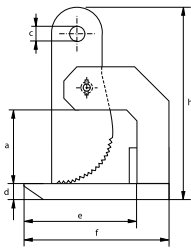

- **Material:** carbon and alloy steel
- **Safety factor:** MBL equals 5 x WLL
- **Standard:** generally to EN 13155, ASME B30.20-2010 and AS 4991
- **Finish:** painted
- **Temperature range:** -40°C up to +100°C
- **Certification:** 2.1 2.2 3.1 MTC[®] CE

type	working load limit per set	width opening	thickness	diameter eye	thickness	length	length	width	length	weight each
	t	a mm	b mm	c mm	d mm	e mm	f mm	g mm	h mm	kg
2 H	2	0-60	16	30	15	118	180	90	287	7
3 H	3	0-60	16	30	20	118	180	90	291	8
4 H	4	0-60	20	30	25	145	220	105	304	13
6 H	6	0-60	20	30	25	145	220	110	307	14
8 H	8	0-60	30	30	35	135	225	120	336	19
10 H	10	0-60	30	30	35	135	225	120	336	19
15 H	15	0-60	35	43	35	147	262	160	344	30
18 H	25	0-60	35	43	40	147	262	175	349	33

INFO



Green Pin BigMouth® Lifting Clamp H-type

Plate clamp with an enlarged opening for horizontal transportation

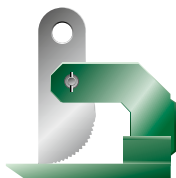

P-6636

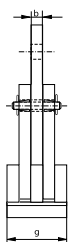
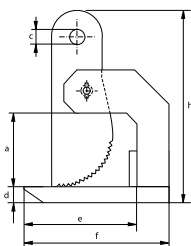

- **Material:** carbon and alloy steel
- **Safety factor:** MBL equals 5 x WLL
- **Standard:** generally to EN 13155, ASME B30.20-2010 and AS 4991
- **Finish:** painted
- **Temperature range:** -40°C up to +100°C
- **Certification:** 2.1 2.2 3.1 MTC[®] CE

type	working load limit per set	width opening	thickness	diameter eye	thickness	length	length	width	length	weight each
	t	a mm	b mm	c mm	d mm	e mm	f mm	g mm	h mm	kg
3 HE	3	0-100	15	30	20	120	180	90	387	10
4 HE	4	0-100	20	30	25	145	220	105	414	15
6 HE	6	0-100	20	30	25	145	220	120	414	16.5
8 HE	8	0-100	30	30	35	135	225	120	428	21
10 HE	10	0-100	30	30	35	135	225	120	428	22
15 HE	15	0-150	35	45	35	240	350	140	665	53

INFO



Green Pin® Beam Lifting Clamp H-type

Clamp for horizontal lifting and transportation of steel beams

- **Material:** carbon and alloy steel
- **Safety factor:** MBL equals 5 x WLL
- **Standard:** generally to EN 13155, ASME B30.20-2010 and AS 4991
- **Finish:** painted
- **Temperature range:** -40°C up to +100°C
- **Certification:** 2.1 2.2 MTC³ CE

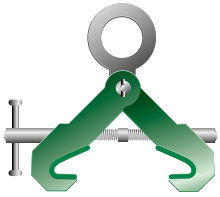

P-6685

type	working load limit	width jaw opening	width jaw opening	length	height	diameter eye inside	width	thickness	width	weight each
	t	a mm	b mm	c mm	d mm	e mm	f mm	g mm	h mm	kg
2 B	2	0-130	75-190	357	345	73	120	113-192	30	5
3 B	3	0-130	75-190	357	345	73	120	113-192	30	5
4 B	4	0-220	150-300	450	422	80	180	185-240	40	15
5 B	5	0-220	150-300	450	422	80	180	185-240	40	15
10 B	10	0-190	350-450	695	653	88	200	400-447	95	50

INFO

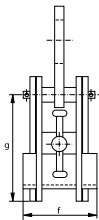
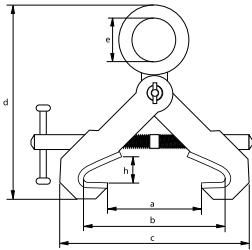

Green Pin BigMouth® Beam Lifting Clamp H-type

Clamp with enlarged opening for horizontal lifting and transportation of steel beams

- **Material:** carbon and alloy steel
- **Safety factor:** MBL equals 5 x WLL
- **Standard:** generally to EN 13155, ASME B30.20-2010 and AS 4991
- **Finish:** painted
- **Temperature range:** -40°C up to +100°C
- **Certification:** 2.1 2.2 MTC³ CE

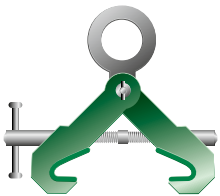

P-6686

type	working load limit	width jaw opening	width jaw opening	length	height	diameter eye inside	width	thickness	width	weight each
	t	a mm	b mm	c mm	d mm	e mm	f mm	g mm	h mm	kg
2 BE	2	0-350	75-420	540	428	73	120	114-275	30	7
3 BE	3	0-350	75-420	540	428	73	120	114-275	30	7
4 BE	4	0-470	150-560	708	545	80	180	173-362	40	18
5 BE	5	0-470	150-560	708	545	80	180	173-362	40	19.5

INFO

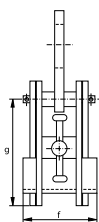
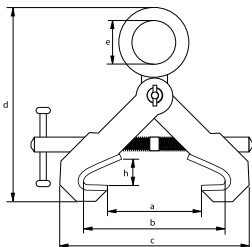

BLOCKS



Applications

Blocks are used in lifting systems, to change load direction or to drag a load. Blocks and the wire ropes they contain make a connection between a load and a lifting device.

Range

Green Pin® offers a wide range of blocks. Blocks are available for head loads ranging from 2 tons up to 30 tons. Other types of blocks can be offered upon special request.

Design

There are different types of blocks with specific designs to suit particular purposes. All types are fitted with conical roller bearings. These can be used for applications with different frequency of use and line speeds. Snatch blocks can be opened up to fit the wire rope easily. There is no need to thread the wire rope through the block.

All types are generally marked as follows:

- Working Load Limit - e.g. 8 t
- manufacturer's symbol - e.g. GP
- wire rope diameter in mm and inches - e.g. 20-22mm $\frac{3}{4}$ - $\frac{7}{8}$ inch
- serial number - e.g. 1234567
- CE conformity code - CE

Finish

Green Pin® Blocks are painted.

Certification

Specific details of certificate availability can be found on each product page. Please verify your certification requirements at the time of order.

Instructions for use

Blocks should be inspected before use to ensure that:

- all markings are legible;
- a block with the correct WLL has been selected;
- the WLL applies to static loads only, the possible occurrence of shock loading must be taken into account when selecting a block;
- the block may never be side loaded but may only be used for in-line use;
- always make sure that the hook, eye or shackle of the block is supporting the load correctly;
- the pin, nut, cotter pin, or any other locking system cannot vibrate out of position;
- the sheaves are functional and rotate easily;
- blocks are free from nicks, gouges and cracks;
- blocks may not be heat treated as this may affect their WLL;
- never modify, repair or reshape a block by machining, welding, heating or bending as this may affect the WLL.

Blocks must be regularly inspected in accordance with the safety standards given in the country of use. This is required because the products in use may be affected by wear, misuse, overloading etc. which may lead to deformation and alteration of the material structure. Inspection should take place at least every six months and more frequently when the blocks are used in severe operating conditions.

Loads on blocks

The WLLs of our blocks are the maximum loads to be applied to the blocks and their connecting fittings. The load on a sheave or block varies with the angle between the lead and load line. See figure 1. When the two lines are parallel, 1 t on the lead line results in a load of 2 t on the fitting. As the working angle between the lines increases, the load on the fitting is reduced by the angle factor as per table 1. All loads shown ignore frictional losses in the lifting system.

Table 1

working angle	angle factor
0°	2
10°	1.99
20°	1.97
30°	1.93
40°	1.87
45°	1.84
50°	1.81
60°	1.73
70°	1.64
80°	1.53
90°	1.41
100°	1.29
110°	1.15
120°	1
130°	0.84
135°	0.76
140°	0.68
150°	0.52
160°	0.35
170°	0.17
180°	0

Figure 1

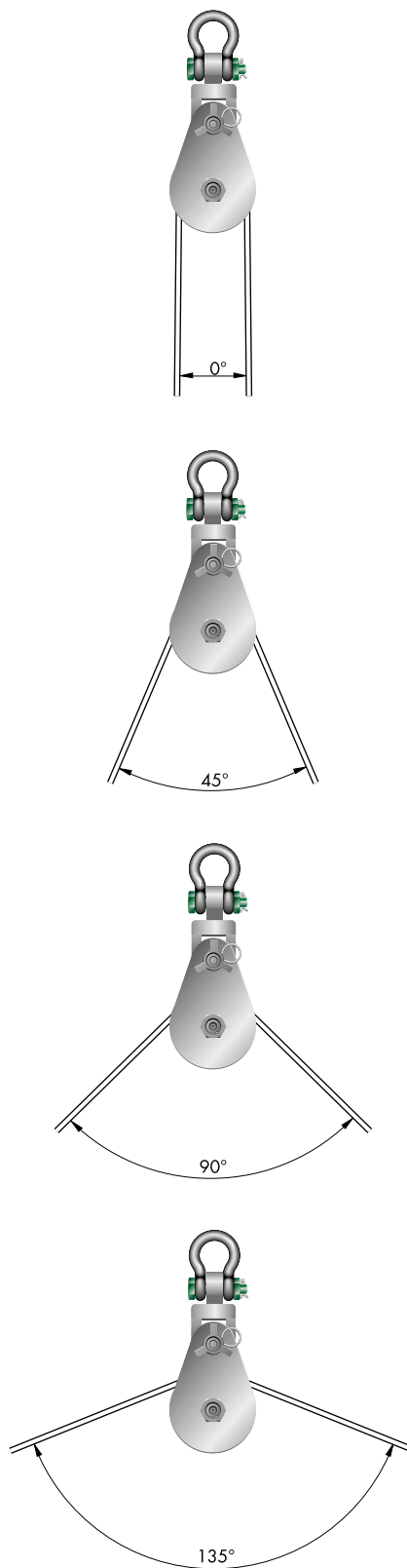



Green Pin® Snatch Block S

Snatch block type 601S with Green Pin® Shackle attached

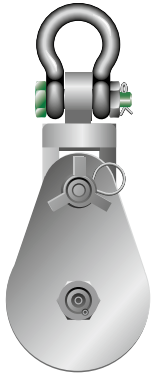

P-6951

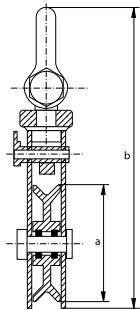
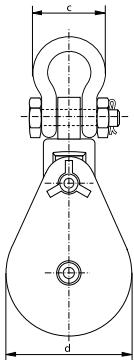

- **Material:** carbon steel, fitted with conical roller bearings
- **Safety factor:** MBL equals 4 x WLL
- **Finish:** painted
- **Certification:** 2.1 2.2 MTC[®] CE
- **Note:** Working Load Limit is on the headlifting

working load limit	diameter wire rope	diameter outside sheave	length	width	width outside	weight each
t	mm	a mm	b mm	c mm	d mm	kg
2	7 - 9	75	293	75	82	3.9
4	10 - 12	115	363	102	120	6.4
4	12 - 14	152	417	102	160	8.4
8	14 - 16	152	477	118	160	14.3
12	14 - 16	152	555	147	160	20
8	20 - 22	152	477	118	160	14.1
12	20 - 22	152	555	147	160	20
15	24 - 26	152	585	162	160	24
4	10 - 12	203	478	102	210	11
12	14 - 16	203	580	147	210	27
8	20 - 22	203	526	118	210	18
12	20 - 22	203	580	147	210	28
15	24 - 26	203	646	162	210	30
8	14 - 16	254	582	118	260	26
8	20 - 22	254	582	118	260	26
12	20 - 22	254	680	147	260	35
15	24 - 26	254	705	162	260	42
8	20 - 22	305	612	118	310	31
12	20 - 22	305	745	147	310	53
15	24 - 26	305	771	162	310	55
8	20 - 22	357	662	118	360	31
12	20 - 22	357	770	147	360	60
15	24 - 26	357	798	162	360	63
22	28 - 32	357	906	216	385	126
8	20 - 22	406	712	118	410	35
12	20 - 22	406	820	147	410	67
15	24 - 26	406	848	162	410	70
22	28 - 32	406	963	216	415	139
8	20 - 22	457	762	118	460	42
12	20 - 22	457	878	147	460	75
15	24 - 26	457	898	162	460	78
22	28 - 32	457	1033	216	465	154
30	28 - 32	457	1083	238	468	218

continued on next page >

Green Pin® Snatch Block S (continued)

Snatch block type 601S with Green Pin® Shackle attached

- **Material:** carbon steel, fitted with conical roller bearings
- **Safety factor:** MBL equals 4 x WLL
- **Finish:** painted
- **Certification:** 2.1 2.2 MTC[®] CE
- **Note:** Working Load Limit is on the headlifting

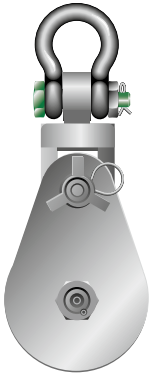

P-6951

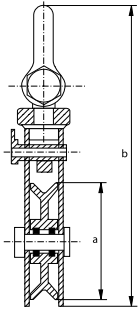
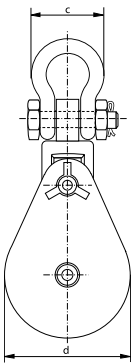

In inch

working load limit	diameter wire rope	diameter outside sheave	length	width	width outside	weight each
t	inch	a inch	b inch	c inch	d inch	lbs
2	$\frac{9}{32} - \frac{3}{8}$	3	$11 \frac{9}{16}$	3	$3 \frac{1}{4}$	8.60
4	$\frac{3}{8} - \frac{1}{2}$	$4 \frac{1}{2}$	$14 \frac{9}{32}$	4	$4 \frac{23}{32}$	14.11
4	$\frac{1}{2} - \frac{9}{16}$	6	$16 \frac{7}{16}$	4	$6 \frac{9}{32}$	18.52
8	$\frac{9}{16} - \frac{5}{8}$	6	$18 \frac{25}{32}$	$4 \frac{5}{8}$	$6 \frac{9}{32}$	31.5
12	$\frac{9}{16} - \frac{5}{8}$	6	$21 \frac{7}{8}$	$5 \frac{25}{32}$	$6 \frac{9}{32}$	44.1
8	$\frac{3}{4} - \frac{7}{8}$	6	$18 \frac{25}{32}$	$4 \frac{5}{8}$	$6 \frac{9}{32}$	31.1
12	$\frac{3}{4} - \frac{7}{8}$	6	$21 \frac{7}{8}$	$5 \frac{25}{32}$	$6 \frac{9}{32}$	44.1
15	1	6	$23 \frac{1}{32}$	$6 \frac{3}{8}$	$6 \frac{9}{32}$	52.9
4	$\frac{3}{8} - \frac{1}{2}$	8	$18 \frac{13}{16}$	4	$8 \frac{9}{32}$	24.3
12	$\frac{9}{16} - \frac{5}{8}$	8	$22 \frac{13}{16}$	$5 \frac{25}{32}$	$8 \frac{9}{32}$	59.5
8	$\frac{3}{4} - \frac{7}{8}$	8	$20 \frac{23}{32}$	$4 \frac{5}{8}$	$8 \frac{9}{32}$	39.7
12	$\frac{3}{4} - \frac{7}{8}$	8	$22 \frac{13}{16}$	$5 \frac{25}{32}$	$8 \frac{9}{32}$	61.7
15	1	8	$25 \frac{7}{16}$	$6 \frac{3}{8}$	$8 \frac{9}{32}$	66.1
8	$\frac{9}{16} - \frac{5}{8}$	10	$22 \frac{29}{32}$	$4 \frac{5}{8}$	$10 \frac{1}{4}$	57.3
8	$\frac{3}{4} - \frac{7}{8}$	10	$22 \frac{29}{32}$	$4 \frac{5}{8}$	$10 \frac{1}{4}$	57.3
12	$\frac{3}{4} - \frac{7}{8}$	10	$26 \frac{3}{4}$	$5 \frac{25}{32}$	$10 \frac{1}{4}$	77.2
15	1	10	$27 \frac{3}{4}$	$6 \frac{3}{8}$	$10 \frac{1}{4}$	92.6
8	$\frac{3}{4} - \frac{7}{8}$	12	$24 \frac{3}{32}$	$4 \frac{5}{8}$	$12 \frac{3}{16}$	68.3
12	$\frac{3}{4} - \frac{7}{8}$	12	$29 \frac{5}{16}$	$5 \frac{25}{32}$	$12 \frac{3}{16}$	116.8
15	1	12	$30 \frac{5}{16}$	$6 \frac{3}{8}$	$12 \frac{3}{16}$	121.3
8	$\frac{3}{4} - \frac{7}{8}$	14	$26 \frac{1}{32}$	$4 \frac{5}{8}$	$14 \frac{5}{32}$	68.3
12	$\frac{3}{4} - \frac{7}{8}$	14	$30 \frac{9}{32}$	$5 \frac{25}{32}$	$14 \frac{5}{32}$	132.3
15	1	14	$31 \frac{3}{8}$	$6 \frac{3}{8}$	$14 \frac{5}{32}$	138.9
22	$1 \frac{1}{8} - 1 \frac{1}{4}$	14	$35 \frac{21}{32}$	$8 \frac{1}{2}$	$15 \frac{5}{32}$	277.8
8	$\frac{3}{4} - \frac{7}{8}$	16	27	$4 \frac{5}{8}$	$16 \frac{5}{32}$	77.2
12	$\frac{3}{4} - \frac{7}{8}$	16	$32 \frac{9}{32}$	$5 \frac{25}{32}$	$16 \frac{5}{32}$	147.7
15	1	16	$33 \frac{3}{8}$	$6 \frac{3}{8}$	$16 \frac{5}{32}$	154.3
22	$1 \frac{1}{8} - 1 \frac{1}{4}$	16	$37 \frac{29}{32}$	$8 \frac{1}{2}$	$16 \frac{11}{32}$	306.5
8	$\frac{3}{4} - \frac{7}{8}$	18	$29 \frac{31}{32}$	$4 \frac{5}{8}$	$18 \frac{1}{8}$	92.6
12	$\frac{3}{4} - \frac{7}{8}$	18	$34 \frac{9}{16}$	$5 \frac{25}{32}$	$18 \frac{1}{8}$	165.3
15	1	18	$35 \frac{11}{32}$	$6 \frac{3}{8}$	$18 \frac{1}{8}$	172.0
22	$1 \frac{1}{8} - 1 \frac{1}{4}$	18	$40 \frac{21}{32}$	$8 \frac{1}{2}$	$18 \frac{5}{16}$	339.5
30	$1 \frac{1}{8} - 1 \frac{1}{4}$	18	$42 \frac{5}{8}$	$9 \frac{3}{8}$	$18 \frac{7}{16}$	480.6



Green Pin® Snatch Block HK

Snatch block type 601H with hook attached

- **Material:** carbon steel, fitted with conical roller bearings
- **Safety factor:** MBL equals 4 x WLL
- **Finish:** painted
- **Certification:** 2.1 2.2 MTC[®] CE
- **Note:** Working Load Limit is on the headfitting

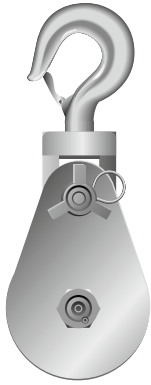

P-6952

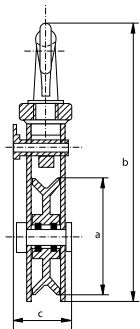
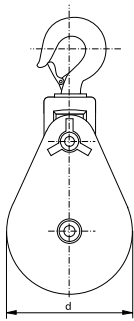

working load limit	diameter wire rope	diameter outside sheave	length	thickness	width outside	weight each
t	mm	a mm	b mm	c mm	d mm	kg
2	7 - 9	75	292	57	82	4
4	10 - 12	115	343	83	120	6.1
4	12 - 14	152	384	83	160	6
8	20 - 22	152	445	108	160	11.8
12	20 - 22	152	572	127	160	23
15	24 - 26	152	587	127	160	23
4	10 - 12	203	435	83	210	8
8	20 - 22	203	495	108	210	16.9
12	20 - 22	203	622	127	210	25
15	24 - 26	203	638	127	210	26
8	20 - 22	254	546	108	260	19
12	20 - 22	254	673	127	260	28
15	24 - 26	254	689	127	260	28
8	20 - 22	305	597	108	310	23
12	20 - 22	305	724	127	310	31
15	24 - 26	305	740	127	310	31
8	20 - 22	357	648	108	360	31
12	20 - 22	357	775	127	360	33
15	24 - 26	357	791	127	360	33
8	20 - 22	406	699	108	410	36
12	20 - 22	406	825	127	410	36
15	24 - 26	406	841	127	410	36
8	20 - 22	457	749	108	460	40
12	20 - 22	457	876	127	460	42
15	24 - 26	457	892	127	460	43

continued on next page >

Green Pin® Snatch Block HK (continued)

Snatch block type 601H with hook attached

- **Material:** carbon steel, fitted with conical roller bearings
- **Safety factor:** MBL equals 4 x WLL
- **Finish:** painted
- **Certification:** 2.1 2.2 MTC[®] CE
- **Note:** Working Load Limit is on the headfitting

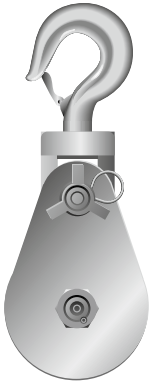

P-6952

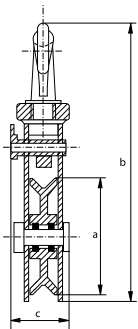
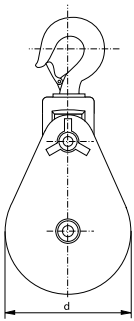

In inch

working load limit	diameter wire rope	diameter outside sheave	length	thickness	width outside	weight each
t	inch	a	b	c	d	lbs
2	$\frac{9}{32} - \frac{3}{8}$	3	$11 \frac{17}{32}$	$2 \frac{1}{4}$	$3 \frac{1}{4}$	8.82
4	$\frac{3}{8} - \frac{1}{2}$	$4 \frac{1}{2}$	$13 \frac{17}{32}$	$3 \frac{9}{32}$	$4 \frac{23}{32}$	13.45
4	$\frac{1}{2} - \frac{9}{16}$	6	$15 \frac{1}{8}$	$3 \frac{9}{32}$	$6 \frac{9}{32}$	13.23
8	$\frac{3}{4} - \frac{7}{8}$	6	$17 \frac{9}{16}$	$4 \frac{1}{4}$	$6 \frac{9}{32}$	26
12	$\frac{3}{4} - \frac{7}{8}$	6	$22 \frac{17}{32}$	5	$6 \frac{9}{32}$	50.7
15	1	6	$23 \frac{1}{8}$	5	$6 \frac{9}{32}$	50.7
4	$\frac{3}{8} - \frac{15}{32}$	8	$17 \frac{5}{32}$	$3 \frac{9}{32}$	$8 \frac{9}{32}$	17.64
8	$\frac{3}{4} - \frac{7}{8}$	8	$19 \frac{17}{32}$	$4 \frac{1}{4}$	$8 \frac{9}{32}$	37.3
12	$\frac{3}{4} - \frac{7}{8}$	8	$24 \frac{1}{2}$	5	$8 \frac{9}{32}$	55.1
15	1	8	$25 \frac{1}{8}$	5	$8 \frac{9}{32}$	57.3
8	$\frac{3}{4} - \frac{7}{8}$	10	$21 \frac{17}{32}$	$4 \frac{1}{4}$	$10 \frac{1}{4}$	41.9
12	$\frac{3}{4} - \frac{7}{8}$	10	$26 \frac{1}{2}$	5	$10 \frac{1}{4}$	61.7
15	$\frac{15}{16} - 1 \frac{1}{32}$	10	$27 \frac{1}{8}$	5	$10 \frac{1}{4}$	61.7
8	$\frac{3}{4} - \frac{7}{8}$	12	$23 \frac{17}{32}$	$4 \frac{1}{4}$	$12 \frac{3}{16}$	50.7
12	$\frac{3}{4} - \frac{7}{8}$	12	$28 \frac{1}{2}$	5	$12 \frac{3}{16}$	68.3
15	1	12	$29 \frac{1}{8}$	5	$12 \frac{3}{16}$	68.3
8	$\frac{3}{4} - \frac{7}{8}$	14	$25 \frac{17}{32}$	$4 \frac{1}{4}$	$14 \frac{5}{32}$	68.3
12	$\frac{3}{4} - \frac{7}{8}$	14	$30 \frac{1}{2}$	5	$14 \frac{5}{32}$	72.8
15	1	14	$31 \frac{1}{8}$	5	$14 \frac{5}{32}$	72.8
8	$\frac{3}{4} - \frac{7}{8}$	16	$27 \frac{17}{32}$	$4 \frac{1}{4}$	$16 \frac{5}{32}$	79.4
12	$\frac{3}{4} - \frac{7}{8}$	16	$32 \frac{1}{2}$	5	$16 \frac{5}{32}$	79.4
15	1	16	$33 \frac{1}{8}$	5	$16 \frac{5}{32}$	79.4
8	$\frac{3}{4} - \frac{7}{8}$	18	$29 \frac{1}{2}$	$4 \frac{1}{4}$	$18 \frac{1}{8}$	88.2
12	$\frac{3}{4} - \frac{7}{8}$	18	$34 \frac{1}{2}$	5	$18 \frac{1}{8}$	92.6
15	1	18	$35 \frac{1}{8}$	5	$18 \frac{1}{8}$	94.8



Green Pin® Snatch Block

Snatch block type 601T

- **Material:** carbon steel, fitted with conical roller bearings
- **Safety factor:** MBL equals 4 x WLL
- **Finish:** painted
- **Certification:** 2.1 2.2 MTC[®] CE
- **Note:** Working Load Limit is on the headfitting



P-6953

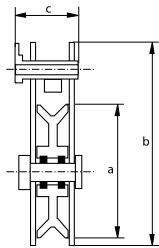
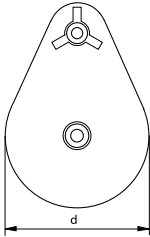

working load limit	diameter wire rope	diameter outside sheave	length	thickness	width outside	weight each
t	mm	a mm	b mm	c mm	d mm	kg
4	10 - 12	115	213	83	120	4
8	20 - 22	152	305	108	160	9
8	20 - 22	203	357	108	210	12
8	20 - 22	254	406	108	260	16

In inch

working load limit	diameter wire rope	diameter outside sheave	length	thickness	width outside	weight each
t	inch	a inch	b inch	c inch	d inch	lbs
4	$\frac{3}{8} - \frac{1}{2}$	4 $\frac{1}{2}$	8 $\frac{3}{8}$	3 $\frac{9}{32}$	4 $\frac{23}{32}$	8.82
8	$\frac{3}{4} - \frac{7}{8}$	6	12	4 $\frac{1}{4}$	6 $\frac{9}{32}$	19.84
8	$\frac{3}{4} - \frac{7}{8}$	8	14 $\frac{1}{32}$	4 $\frac{1}{4}$	8 $\frac{9}{32}$	26.5
8	$\frac{3}{4} - \frac{7}{8}$	10	15	4 $\frac{1}{4}$	10 $\frac{1}{4}$	35.3



GENERAL HARDWARE



Applications

General hardware items, such as carabine hooks, quick links and s-hooks, are suitable for many different applications in various market segments such as agriculture, industry, transportation, etc.

Range

Van Beest offers a wide range of general hardware products to complement the Green Pin® assortment, such as:

- RFID tags;
- Split pins;
- Spring pins;
- Linch pins;
- Quick links;
- Carabine hooks.

Design

General hardware items are designed for multiple purpose usage.

Finish

Most general hardware items are electro-galvanized. Specific details of the finish of general hardware items can be found on each product page.

Certification

Specific details of certificate availability can be found on each product page. Please verify your certification requirements at the time of order.

Instructions for use

Items should be inspected before use to ensure that they are free from nicks, gouges and cracks. Also:

- the item should not be used for lifting – general hardware items are not suitable for lifting applications;
- never modify, repair or reshape an item by machining, welding, heating or bending, as this may affect its performance.

The products must be regularly inspected in accordance with the safety standards given in the country of use. This is required because the products in use may be affected by issues such as wear, misuse and overloading, which may lead to deformation and alteration of the material structure. Inspection should take place at least every six months and more frequently when the products are used in severe operating conditions.



Green Pin® RFID Tag

Accessory for radio-frequency identification of slings

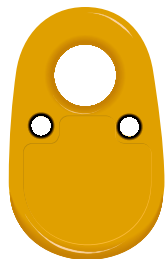

TAGRfid

- **Material:** stainless steel
- **Finish:** polymer
- **Certification:** 2.1
- **Note:** contains a high frequency 13.56 MHz iCode ISO 15693 compliant chip with individual serial number

length	width	diameter	diameter	weight per 100 pcs
a mm	b mm	c mm	d mm	kg
53	33	12	4	1.8

RFID INFO

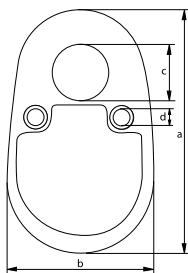

Green Pin® RFID Chip

Accessory for radio-frequency identification of slings



CHIPRFID

- **Material:** polymer
- **Standard:** RF Protocol ISO 15693
Operating Frequency HF - 13.56 MHz
- **Finish:** yellow
- **Temperature range:** -40°C up to +100°C
- **Certification:** 2.1

diameter	thickness	weight per 100 pcs
a mm	b mm	kg
6	2	0.02

RFID INFO

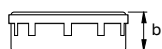
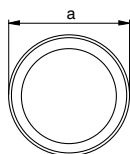



Green Pin® ID Tag

Aluminium identification tag

- Material: aluminium
- Finish: see table below
- Certification: 2.1



TAG

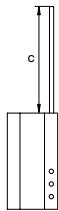
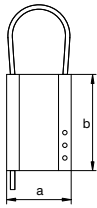

partnumber	finish	width	length	length	weight each
		a mm	b mm	c mm	kg
TAGVIERGE	self coloured	51	76	222	0.07
TAGJ	anodized yellow	51	76	222	0.07
TAGGREEN	anodized green	51	76	222	0.07
TAGRED	anodized red	51	76	222	0.07
TAGBLUE	anodized blue	51	76	222	0.07
TAGDEMI	self coloured	51	38	260	
TAGB w/out wire rope	self coloured	51	76		0.06

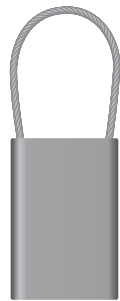

TAGVIERGE

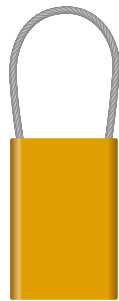

TAGJ



TAGGREEN



TAGRED



TAGBLUE

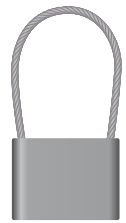

TAGDEMI



Green Pin® ID Tag for Grade 8 Slings

Forged identification tag for grade 8 slings

- **Material:** drop forged mild steel
- **Finish:** electro galvanized
- **Certification:** 2.1



TAGF

width	length	width inside	length inside	weight each
a mm	b mm	c mm	d mm	kg
75	115	35	32	0.28

RFID

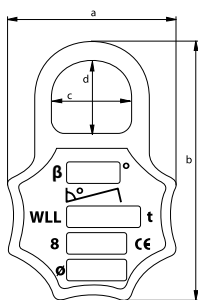

Green Pin® ID Tag for Grade 10 Slings

Forged identification tag for grade 10 slings

- **Material:** drop forged mild steel
- **Finish:** electro galvanized
- **Certification:** 2.1



UTAGF

width	length	width inside	length inside	weight each
a mm	b mm	c mm	d mm	kg
79	121	35	32	0.30

RFID

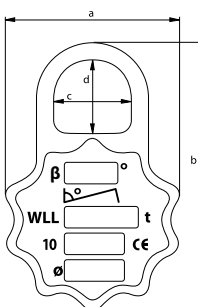



Split pins

- **Material:** mild steel
- **Finish:** electro-galvanized
- **Certification:** 2.1

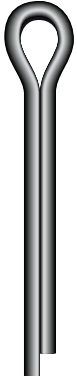

E-7950

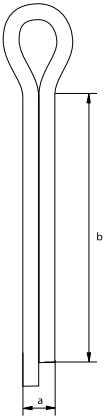

diameter		length	weight per 100 pcs
a mm		b mm	kg
2.5		20	0.08
4		32	0.3
5		36	0.6
6		45	1.2
8		63	2.8
8		80	4.4
8		100	4.4
8		125	5.5
8		150	6.6
10		71	5
10		90	6
10		100	6.6
10		120	4.4
12		140	7
12		160	7
12		180	7
13		110	12.1
16		160	16
16		200	20
20		230	30
20		265	17.6

continued on next page >

C

Split pins (continued)

- **Material:** mild steel
- **Finish:** electro-galvanized
- **Certification:** 2.1



E-7950

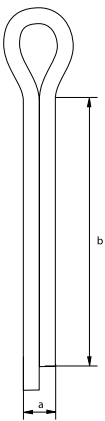

split pins	for shackle									
	G-4163 G-4143	G-4153 G-4133	P-6036 P-6016 ≤150	G-6038 P-6018	P-6033 P-6013 ≤150	G-5263 G-5243	G-5163 G-5143	P-6031 P-6011 ≤150	G-4263 G-4243	G-4553
a x b mm	WLL t	WLL t	WLL t	WLL t	WLL t	WLL t	WLL t	WLL t	WLL t	WLL t
2.5 x 20	0.5									
	0.75									
	1									
	1.5									
4 x 32	2	2				3.3	2			
	3.25	3.25				5	3.25			
5 x 36	4.75	4.75			7	7	4.75		4.75	4.6
	6.5	6.5				9.5	6.5			
6 x 45	8.5	8.5			12.5	12.5	8.5		6.5	8.6
	9.5	9.5			18	15	9.5		8.5	
	12	12				18	12		9.5	
8 x 63	13.5	13.5				21	13.5		12	15.5
	17	17				30	17		16	
8 x 80					30					
					40					
10 x 71	25	25				40	25		25	
	35	35				55	35		30	
10 x 90	42.5	42.5				85	42.5		55	
	55	55					55			
10 x 100	85	85			55	120	85		75	
					75					
10 x 120					125					
12 x 140					150					
					200					
12 x 160					250					
12 x 180					300					
13 x 110			120	120		150		120		
			150			175		150		
16 x 160			200					200		
			250					250		
			300					300		
16 x 200			400					400		
			500					500		
20 x 230			600					600		
			700					700		
			800					800		
20 x 265			900					900		
			1000					1000		

C

Spring pins, single type

- **Material:** mild steel
- **Finish:** electro-galvanized
- **Certification:** 2.1

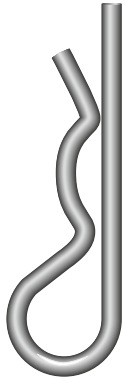

diameter	length	diameter	diameter	weight per 100 pcs
a mm	b mm	c mm	d mm	kg
2	50	10	9 - 14	0.3
3	60	18	10 - 16	0.9
4	60	20	16 - 20	1.6
5	85	24	20 - 28	3.3
6	105	30	28 - 40	6.2
7	105	30	28 - 45	8.3
8	110	28	30 - 45	10.5

E-7930

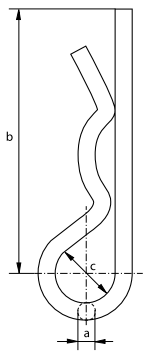

spring pin	for shackle						
	G-4163	G-4153	P-6033	G-5263	G-5163	G-4263	G-4553
a x b mm	WLL t	WLL t	WLL t	WLL t	WLL t	WLL t	WLL t
2 x 50	2	2		3.3	2		
3 x 60	3.25	3.25		5	3.25		
4 x 60	4.75	4.75	7	7	4.75	4.75	4.6
	6.5	6.5		9.5	6.5		
5 x 85	8.5	8.5	12.5	12.5	8.5	6.5	8.6
	9.5	9.5	18	15	9.5	8.5	
	12	12		18	12	9.5	
6 x 105	13.5	13.5		21	13.5	12	15.5
	17	17		30	17	16	
7 x 105	25	25	30	40	25	25	
			40				

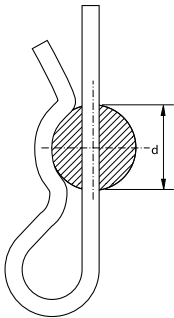

C

Spring pins, double type

- **Material:** mild steel
- **Finish:** electro-galvanized
- **Certification:** 2.1

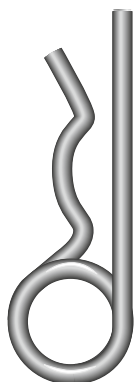

E-7931

diameter	length	diameter	diameter	weight per 100 pcs
a mm	b mm	c mm	d mm	kg
2	38	10	08 - 14	0.4
3	62	16	14 - 20	1.4
4	78	23	17 - 24	3
5	92	26	18 - 30	5.3
6	120	30	24 - 36	9.6
7	130	30	24 - 40	13.5
7	150	30	45 - 56	13.5
8	130	30	24 - 45	17.8

spring pin	for shackle									
	G-4163	G-4153	P-6033	G-5263	G-5163	G-4263	G-4553	P-5361D/F	P-5363	P-5365
a x b mm	WLL t	WLL t	WLL t	WLL t	WLL t	WLL t	WLL t	WLL t	WLL t	WLL t
2 x 38	2	2		3.3	2					
3 x 62	3.25	3.25		5	3.25			6.5		6.5 ~ 12
4 x 78	4.75	4.75	7	7	4.75	4.75	4.6		6.5	17
	6.5	6.5		9.5	6.5					25
	8.5	8.5		12.5	8.5					35
5 x 92	9.5	9.5	12.5	15	9.5	6.5	8.6	9.5	9.5	42.5 ~ 85
	12	12	18	18	12	8.5			12	120 ~ 250
						9.5				
6 x 120	13.5	13.5		21	13.5	12	15.5	12	17	
	17	17		30	17	16		17		
								25		
7 x 150	35	35	55	55	35	30		42.5	35	
	42.5	42.5	75	85	42.5	55		55	42.5	
	55	55			55				55	
8 x 130	25	25	30	40	25	25		35	25	
			40							

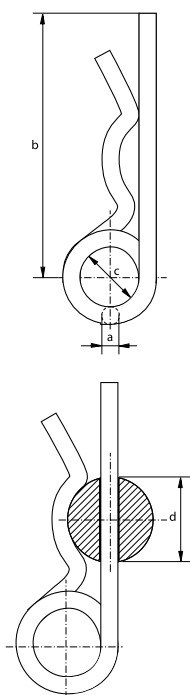

C

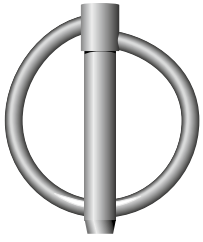

E-7940

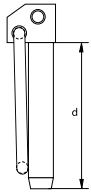
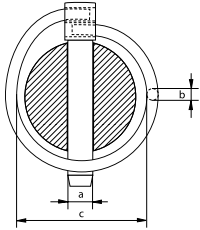

Linch pins

With round spring ring

- **Material:** mild steel
- **Finish:** electro-galvanized
- **Certification:** 2.1

diameter pin	diameter spring ring	width inside spring ring	length pin	weight per 100 pcs
a mm	b mm	c mm	d mm	kg
4.5	2	41	42	2
6	3.4	41	42	2.8
7	3.4	41	42	3
8	3.4	41	42	3.5
9	3.4	41	42	3.8
10	3.4	41	42	4.4
11	3.4	41	42	4.6

linch pin	for shackle						
	G-4163	G-4153	P-6033	G-5263	G-5163	G-4263	G-4553
diameter mm	WLL t	WLL t	WLL t	WLL t	WLL t	WLL t	WLL t
4.5	4.75	4.75	7	7	4.75	4.75	4.6
	6.5	6.5		9.5	6.5	6.5	8.6
	8.5	8.5		12.5	8.5	8.5	
6	9.5	9.5	12.5	15	9.5	9.5	
	12	12	18	18	12		
8	13.5	13.5	30	21	13.5	12	15.5
	17	17		30	17	16	

C

Quick links, standard type

- **Material:** mild steel
- **Finish:** electro-galvanized
- **Certification:** 2.1

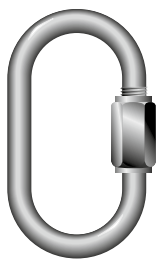

E-7300

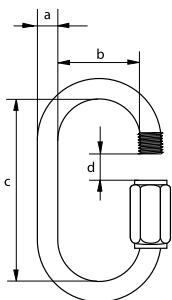

diameter	width inside	length inside	opening	minimum breaking load	weight per 100 pcs
a mm	b mm	c mm	d mm	kg	kg
3.5	10	29	5	240	0.9
4	11	32	5	300	1.3
5	13	39	6	540	2
6	14	46	7	750	3.3
7	16	51	8	1125	5.3
8	17	59	10	1500	7.5
9	17	64	11	2000	10.3
10	20	70	12	2400	13
12	23	83	14	3600	25
14	26	97	17	5000	35
16	29	112	20	6000	50

C

Quick links, with enlarged opening

- **Material:** mild steel
- **Finish:** electro-galvanized
- **Certification:** 2.1

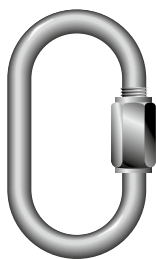

E-7310

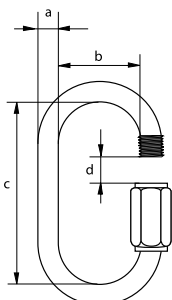

diameter	width inside	length inside	opening	minimum breaking load	weight per 100 pcs
a mm	b mm	c mm	d mm	kg	kg
4	12	45	11	800	1.4
5	14	52	13	1250	2.5
6	16	58	14	1750	4.2
7	17	65	16	2500	6.7
8	19	73	17	3250	9.4
9	20	79	19	4000	13.1
10	22	88	20	5000	17.5
12	25	102	23	6250	28.2
14	28	114	26	10000	45.6
16	31	129	29	12500	60.7

C

Carabine hooks, standard type

- **Material:** mild steel
- **Finish:** electro-galvanized
- **Certification:** 2.1

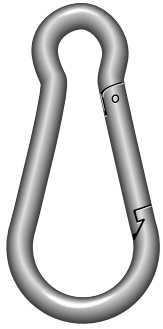

E-7200

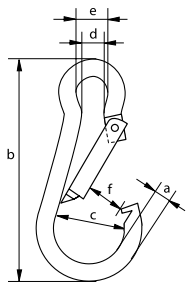

diameter	length	width	width inside	width inside	width opening	minimum breaking load	weight per 100 pcs
a mm	b mm	c mm	d mm	e mm	f mm	kg	kg
4	40	14	5	7	6	-	0.6
5	50	16	7	8	6	100	0.8
6	60	18	7	9	7	120	2.4
7	70	22	9	10	8	180	2.6
8	80	24	11	12	9	300	4.4
9	90	26	11	12	10	330	6.4
10	100	30	12	15	11	460	12.1
11	120	36	14	18	15	600	12.5
12	140	40	16	20	19	680	24.7
13	160	44	20	22	24	800	25
14	180	48	20	22	28	860	35
15	200	60	20	22	35	1370	57.2

C

Carabine hooks, with pressed thimble

- **Material:** mild steel
- **Finish:** electro-galvanized
- **Certification:** 2.1

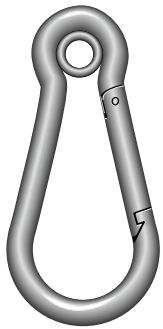

E-7210

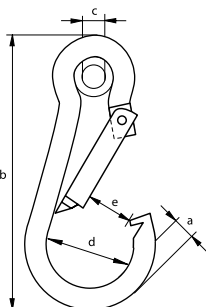

diameter	length	diameter inside thimble	width	width opening	minimum breaking load	weight per 100 pcs
a mm	b mm	c mm	d mm	e mm	kg	kg
4	40	4	14	6	-	0.8
5	50	5	16	6	100	1.6
6	60	6	18	7	120	2.6
7	70	7	22	8	180	4.4
8	80	10	24	9	300	6.4
9	90	12	26	10	330	9.3
10	100	13	30	11	460	12.5
11	120	13	36	15	600	19.5
12	140	15	40	19	680	25
13	160	17	44	24	800	35
14	180	17	48	28	860	50

C

Carabine hooks, with screw nut

- **Material:** mild steel
- **Finish:** electro-galvanized
- **Certification:** 2.1

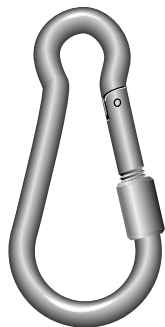

E-7220

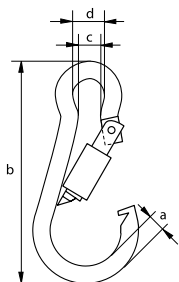

diameter	length	width inside	width inside	minimum breaking load	weight per 100 pcs
a mm	b mm	c mm	d mm	kg	kg
4	40	4	7	-	1.7
5	50	5	7	100	1.9
6	60	6	8	120	2.7
7	70	7	10	180	4.5
8	80	10	12	300	6.5
9	90	12	12	330	10.3
10	100	13	15	460	13.4
11	120	13	16	600	19
12	140	15	19	680	26.5
13	160	17	28	800	37
14	180	17	28	860	52

SPARE PARTS



Applications

Spare parts are replacement components for current grade 8, grade 10, stainless steel or Green Pin Tycan® products.

Range

Green Pin® offers a wide range of spare parts such as:

- Spare Kit for Self Locking Hooks;
- Spare Kit for Clevis Fittings;
- Grade 8 and grade 10 Latches.

Finish

Specific details of the finish of spare parts can be found on each product page.

Certification

Specific details of certificate availability can be found on each product page. Please verify your certification requirements at the time of order.

Instructions for use

Items should be inspected before use to ensure that:

- items are not distorted or unduly worn;
- items are free from nicks, gouges and cracks;

Also:

- all components of the sling must be of the same steel grade;
- items may not be heat treated;
- never modify, repair or reshape an item by machining, welding, heating or bending, as this may affect its performance.



Green Pin® Self Locking Hooks GR8/GR10 Spare Kit

Replacement kit for grade 8 and 10 self locking hooks

- **Material:** steel
- **Finish:** self coloured
- **Temperature range:** -40°C up to +200°C
- **Certification:** 2.1
- **Note:** plastic tube included, to make assembly easier



VR

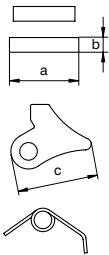

partnumber	length pin	diameter pin	width	weight each
	a mm	b mm	c mm	kg
VR1	22	6	28	0.02
VR2	26	6	31	0.03
VR3	32	8	37	0.05
VR4	40	10	47	0.1
VR5	55	10	58	0.2

partnumber	for fitting										
	GKO	XLO	UXLO	GKC	XLC	UXLC	GKE	XLE	UXLE	XLBA	XLS
VR1	GPGK01	GPXLO0	GPUXLO0	GPGKC1	GPXLC0	GPUXLC0	GPGKE1	GPXLE0	GPUXLE0	GPXLBA0	
VR2	GPGK02	GPXLO1	GPUXLO1	GPGKC2	GPXLC1	GPUXLC07	GPGKE2	GPXLE1	GPUXLE1	GPXLBA1	
						GPUXLC1					
VR3	GPGK03	GPXLO2	GPUXLO2	GPGKC3	GPXLC2	GPUXLC2	GPGKE3	GPXLE2	GPUXLE2	GPXLBA2	GPXLS60
VR4	GPGK04	GPXLO3	GPUXLO3	GPGKC4	GPXLC3	GPUXLC3	GPGKE4	GPXLE3	GPUXLE3	GPXLBA3	
VR5	GPGK05	GPXLO4	GPUXLO4	GPGKC5	GPXLC4	GPUXLC4	GPGKE5	GPXLE4	GPUXLE4	GPXLBA4	
	GPGK06	GPXLO5	GPUXLO5	GPGKC6	GPXLC5	GPUXLC5	GPGKE6	GPXLE5	GPUXLE5		

INFO



Green Pin® Clevis Fittings GR8 Spare Kit

Grade 8 spare kit for clevis fittings

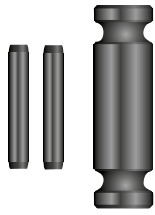

- **Material:** alloy steel, grade 8, quenched and tempered
- **Finish:** self coloured
- **Temperature range:** -40°C up to +200°C
- **Certification:** 2.1 3.1
- **Note:** GPAC7 is suitable for 8 mm clevis components and fits 7 mm hoist chain, GPAC9 is suitable for 10 mm clevis components and fits 9 mm hoist chain

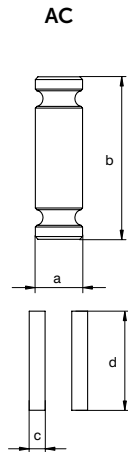

partnumber	diameter pin	length pin	diameter pin	length pin	weight each
	a mm	b mm	c mm	d mm	kg
GPAC5	6	28	3	14	0.01
GPAC6	8	28	3	14	0.01
GPAC7	8	32	3	22	0.02
GPAC7/8	9	32	3	22	0.02
GPAC9	10	41	4	24	0.04
GPAC10	13	41	4	24	0.04
GPAC13	16	53	4	32	0.08
GPAC16	20	66	5	35	0.16
GPAC18/20	24	80	6	45	0.28
GPAC22	28	95	8	50	0.45

partnumber	for fitting									
	MP	CO	CSC	CSECA	XLC	GKC	GC	GCV	CRC	XLBA
GPAC5	GPMP5	GPCO5	GPCSC5	GPCSECA5	GPXLC05		GPGC5	GPGCV5		GPXLB05
GPAC6	GPMP6	GPCO6	GPCSC6	GPCSECA6	GPXLC0		GPGC6	GPGCV6	GPCRC6	GPXLB0
GPAC7	GPMP7/8	GPCO7/8	GPCSC7/8	GPCSECA7/8	GPXLC1	GPGKC1	GPGC7/8		GPCRC7/8	GPXLB1
GPAC7/8	GPMP7/8	GPCO7/8	GPCSC7/8	GPCSECA7/8	GPXLC1	GPGKC1	GPGC7/8	GPGCV8	GPCRC7/8	GPXLB1
GPAC9	GPMP10	GPCO10	GPCSC10	GPCSECA10	GPXLC2	GPGKC2	GPGC10	GPGCV10	GPCRC10	GPXLB2
GPAC10	GPMP10	GPCO10	GPCSC10	GPCSECA10	GPXLC2	GPGKC2	GPGC10	GPGCV10	GPCRC10	GPXLB2
GPAC13	GPMP13	GPCO13	GPCSC13	GPCSECA13	GPXLC3	GPGKC3	GPGC13	GPGCV13	GPCRC13	GPXLB3
GPAC16	GPMP16	GPCO16	GPCSC16	GPCSECA16	GPXLC4	GPGKC4	GPGC16	GPGCV16	GPCRC16	GPXLB4
GPAC18/20	GPMP18/20	GPCO18/20	GPCSC18/20		GPXLC5	GPGKC5	GPGC18/20	GPGCV20		
GPAC22			GPCSC22			GPGKC6				

INFO

Green Pin® Connecting Link Spare Kit GR8

Grade 8 spare kit for connecting link

- **Material:** alloy steel, grade 8, quenched and tempered
- **Finish:** self coloured
- **Temperature range:** -40°C up to +200°C
- **Certification:** 2.1 3.1

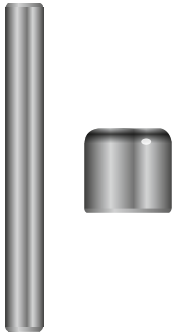

RMJ

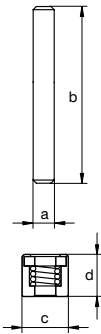

partnumber	diameter		width		weight each
	a mm	b mm	c mm	d mm	
GPRMJ6	5	43	11	10	0.01
GPRMJ7/8	6	54	13	14	0.02
GPRMJ10	8	66	15	18	0.04
GPRMJ13	10	84	20	21	0.1
GPRMJ16	12	105	23	25	0.15
GPRMJ18/20	15	122	27	32	0.25
GPRMJ22	17	145	29	39	0.38
GPRMJ26	20	162	32	44	0.54
GPRMJ32	24	198	37	50	1

partnumber	for fitting	
	MJ	MJS
GPRMJ6	GPMJ6	
GPRMJ7/8	GPMJ7/8	GPMJS7/8
GPRMJ10	GPMJ10	GPMJS10
GPRMJ13	GPMJ13	GPMJS13
GPRMJ16	GPMJ16	
GPRMJ18/20	GPMJ18/20	
GPRMJ22	GPMJ22	
GPRMJ26	GPMJ26	
GPRMJ32	GPMJ32	



Green Pin® Latch GR8

Forged latch for grade 8

- **Material:** steel
- **Finish:** painted yellow (J), red (R) or white. GPLF7 and GPLF8 are self coloured
- **Temperature range:** -40°C up to +200°C
- **Certification:** 2.1

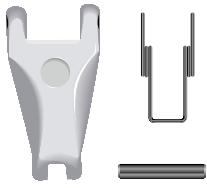

LF

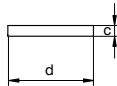
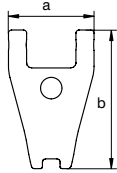

partnumber	width		length		diameter pin	length pin	weight each
	a mm	b mm	c mm	d mm	kg		
GPLF0	24	44	4	24	0.03		
GPLF1	31	59	5	30	0.07		
GPLF2	41	65	5	40	0.11		
GPLF3	41	79	6	40	0.18		
GPLF4	46	81	6	45	0.22		
GPLF5	50	100	8	50	0.33		
GPLF6	55	119	10	55	0.55		
GPLF7	51	117	8	68	0.19		
GPLF8	60	141	8	74	0.34		

partnumber	for fitting					
	CSO	CSC	CSE	CSECA	GH	CST
GPLF0	GPCSO5/6	GPCSC5	GPCSE5/6	GPCSECA5		
		GPCSC6		GPCSECA6		
GPLF1	GPCSO7/8	GPCSC7/8	GPCSE7/8	GPCSECA7/8	GPGH1-GPGH2-GPGH3	GPCST75
GPLF2	GPCSO10	GPCSC10	GPCSE10	GPCSECA10	GPGH4	
GPLF3	GPCSO13	GPCSC13	GPCSE13	GPCSECA13	GPGH5 - GPGH8	
GPLF4	GPCSO16	GPCSC16	GPCSE16	GPCSECA16		
GPLF5	GPCSO18/20	GPCSC18/20	GPCSE18/20		GPGH10	
GPLF6	GPCSO22	GPCSC22			GPGH15	
GPLF7	GPCSO26					
GPLF8	GPCSO32					

INFO



Green Pin® Clevis For Web Sling Connector GR8 Spare Kit

Grade 8 spare kit for clevis for web sling connector

- **Material:** alloy steel, grade 8, quenched and tempered
- **Finish:** self coloured
- **Temperature range:** -40°C up to +200°C
- **Certification:** 2.1 3.1

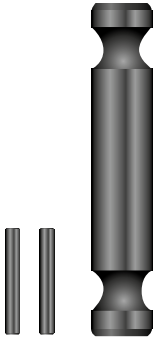

RCOS

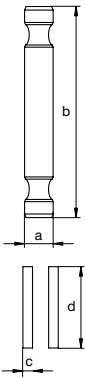

partnumber	diameter pin	length pin	diameter pin	length pin	weight each
	a mm	b mm	c mm	d mm	kg
GPRCOS7/8	9	58	3	22	0.03
GPRCOS10	13	74	4	24	0.08
GPRCOS13	16	94	4	32	0.15
GPRCOS16	20	116	5	35	0.25

partnumber	for fitting	
	COS	XLS
GPRCOS7/8	GPCOS60	
GPRCOS10	GPCOS90	
GPRCOS13	GPCOS150	GPXLS60
GPRCOS16	GPCOS240	



Green Pin® Clevis Fittings GR10 Spare Kit

Grade 10 spare kit for clevis fittings

- **Material:** alloy steel, grade 10, quenched and tempered
- **Finish:** self coloured
- **Temperature range:** -40°C up to +200°C
- **Certification:** 2.1 3.1

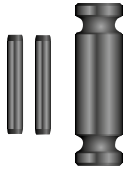

UAC

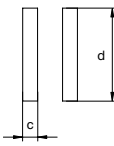
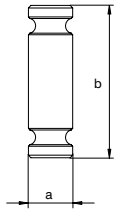

partnumber	diameter pin	length pin	diameter pin	length pin	weight each
	a mm	b mm	c mm	d mm	kg
GPUAC6	8	28	3	14	0.01
GPUAC7	10	32	3	22	0.02
GPUAC8	10	32	3	22	0.02
GPUAC10	13	41	4	24	0.04
GPUAC13	16	53	4	32	0.08
GPUAC16	20	66	5	35	0.16
GPUAC20	24	80	6	45	0.28

partnumber	for fitting					
	UMP	UCO	UCSC	UXLC	UGC	UGCV
GPUAC6	GPUMP6	GPUCO6	GPUCSC6	GPUXLC0	GPUGC6	GPUGCV6
GPUAC7	GPUMP7	GPUCO7	GPUCSC7	GPUXLC07		
GPUAC8	GPUMP8	GPUCO8	GPUCSC8	GPUXLC1	GPUGC8	GPUGCV8
GPUAC10	GPUMP10	GPUCO10	GPUCSC10	GPUXLC2	GPUGC10	GPUGCV10
GPUAC13	GPUMP13	GPUCO13	GPUCSC13	GPUXLC3	GPUGC13	GPUGCV13
GPUAC16	GPUMP16	GPUCO16	GPUCSC16	GPUXLC4	GPUGC16	GPUGCV16
GPUAC20			GPUCSC20	GPUXLC5	GPUGC20	GPUGCV20



Green Pin® Connecting Link Spare Kit GR10

Grade 10 spare kit for connecting link

- **Material:** alloy steel, grade 10, quenched and tempered
- **Finish:** self coloured
- **Temperature range:** -40°C up to +200°C
- **Certification:** 2.1 3.1

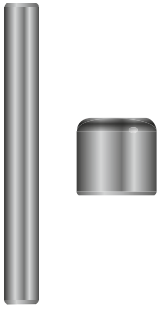

URMJ

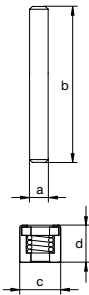

partnumber	diameter pin	length pin	diameter	width	weight each
	a mm	b mm	c mm	d mm	kg
GPURMJ6	5	43	11	12	0.01
GPURMJ8	6	57	13	15	0.02
GPURMJ10	8	66	17	17	0.02
GPURMJ13	10	84	20	22	0.05
GPURMJ16	12	105	25	25	0.1
GPURMJ20	17	122	32	31	0.15

partnumber	for fitting	
	UMJ	UMJT
GPURMJ6	GPUMJ6	
GPURMJ8	GPUMJ8	GPUMJT15
GPURMJ10	GPUMJ10	GPUMJT20
GPURMJ13	GPUMJ13	GPUMJT30
GPURMJ16	GPUMJ16	
GPURMJ20	GPUMJ20	



Green Pin® Latch GR10

Forged latch for grade 10

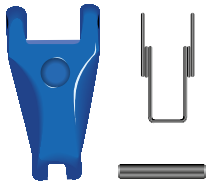

ULF

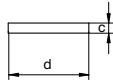
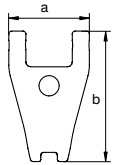

- **Material:** steel
- **Finish:** painted blue
- **Temperature range:** -40°C up to +200°C
- **Certification:** 2.1

partnumber	width	length	diameter pin	length pin	weight each
	a mm	b mm	c mm	d mm	kg
GPULF0	24	44	4	24	0.03
GPULF1	31	59	5	30	0.07
GPULF2	41	65	5	40	0.11
GPULF3	41	79	6	40	0.18
GPULF4	46	81	6	45	0.2
GPULF5	50	100	8	50	0.4

partnumber	for fitting		
	UCSO	UCSC	UCSCT
GPULF0	GPUCSO6	GPUCSC6	
GPULF1	GPUCSO8	GPUCSC7	GPUCSCT15
		GPUCSC8	
GPULF2	GPUCSO10	GPUCSC10	GPUCSCT20
GPULF3	GPUCSO13	GPUCSC13	GPUCSCT30
GPULF4	GPUCSO16	GPUCSC16	
GPULF5	GPUCSO20	GPUCSC20	



Green Pin Tycan® Clevis Fittings GR10 Spare Kit

Grade 10 spare kit for clevis fittings

- **Material:** alloy steel, grade 10, quenched and tempered
- **Finish:** self coloured
- **Temperature range:** -40°C up to +200°C
- **Certification:** 2.1 3.1

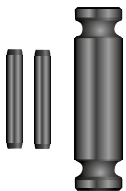

UACT

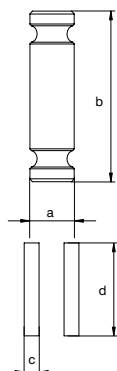

partnumber	diameter pin	length pin	diameter pin	length pin	weight each
	a mm	b mm	c mm	d mm	kg
GPUACT15	13	43	5	30	0.04
GPUACT20	16	56	5	40	0.08
GPUACT25	20	66	5	35	0.16
GPUACT30	20	72	6	40	0.16

partnumber	for fitting	
	UCSCT	UCRCT
GPUACT15	GPUCSCT15	GPUCRCT15
GPUACT20	GPUCSCT20	GPUCRCT20
GPUACT25		GPUCRCT25
GPUACT30	GPUCSCT30	GPUCRCT30

C

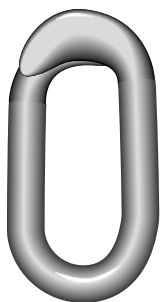

E-7910

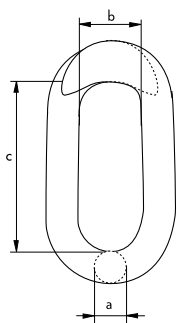

Chain repair links

Commercial quality

- **Material:** mild steel
- **Finish:** electro-galvanized
- **Certification:** 2.1

diameter	width inside	length inside	opening	weight per 100 pcs
a mm	b mm	c mm	d mm	kg
3	6.5	16.5	4	0.4
4	8	20	5.5	0.8
4.5	9	22	6	1.1
5	9.5	23	6	1.2
5.5	10.5	26	6	1.8
6	10.5	29	7	2.1
6.5	11.5	30	8	3.2
7	13.5	32	8.5	3.9
8	15	37	9	5.6
9	16.5	37.5	9	7.6
10	17	37.5	9	9.5
12	25	50	12	10



STAINLESS STEEL PRODUCTS



Applications

The use of stainless steel products is recommended for circumstances in which corrosion may cause problems.

Range

Green Pin® offers a wide range of stainless steel items such as shackles, chain, chain fittings, thimbles, wire rope clips, eye bolts, rigging screws, etc. With the wide range of stainless steel items in the Green Pin® assortment, a complete sling from the top master link to the hooks can be assembled. Van Beest offers a wide range of other stainless steel items to complement the Green Pin® assortment.

Design

Stainless steel items supplied by Green Pin® are all manufactured from stainless steel quality AISI 316 or 316L, except for product groups R-7856, R-7850, R-7852 and R-7854 which are manufactured from AISI 304. Most stainless steel items have an equivalent in a regular steel quality, we refer to the specific chapters for further details.

Most stainless steel components are generally marked with:

- manufacturer's symbol - GP
- chain diameter in mm and/or inch - e.g. 13 and/or 1/2"
- traceability code - e.g. HA
- steel grade - 5
- item code - e.g. MJ1
- origin - e.g. France

Finish

All stainless steel items are polished.

Instructions for use

Please refer to the previous product chapters in this catalogue for details on the use of specific items. In general, items should be inspected before use to ensure that:

- all markings are legible;
- items are not distorted or unduly worn;
- the pin, nut, cotter pin, or any other locking system cannot vibrate out of position;
- the item is free from nicks, gouges and cracks.

Also:

- never modify, repair or reshape an item by machining, welding, heating or bending, as this may affect the strength;
- make sure to select items with the correct WLL. Please refer to the EN818 standard for chain slings for further details;
- make sure that the master links and the other items of the sling are all made of stainless steel suitable for lifting purposes;
- items should be used for in-line lifting only;
- items may not be heat treated, as this may affect their WLL.

Stainless steel products must be regularly inspected in accordance with the safety standards given in the country of use. This is required because the products in use may be affected by issues such as wear, misuse and overloading, which may lead to deformation and alteration of the material structure. Inspection should take place at least every six months and more frequently when the products are used in severe operating conditions.

Corrosion resistance table for stainless steel AISI 316L

This table offers a general guideline only. The material must always be tested for your specific conditions.

Acetic acid <20%	S
Ammonia (100%)	S
Ammonium chloride <1%	S
Ammonium nitrate 10% - 50%	S
Ammonium sulphate <10%	L
Benzene	S
Calcium hypochlorite (100%)	U
Citric acid <10%	S
Copper sulphate <10%	S
Ethanol	S
Gasoline	S
Hydrochloric acid (all concentrations)	U

Hydrogen cyanide 100%	L
Hydrogen peroxide <35%	S
Hydrogen sulphide 100%	S
Mineral oil	S
Nitric acid <10%	S
Potassium sulphate <10%	S
Sodium chloride <5%	S
Sodium hypochlorite <20%	L
Sodium nitrate 10% - 40%	S
Sodium sulphate <10%	S
Zinc chloride <10%	S
Zinc sulphate <10%	S

Abbreviations used

S = satisfactory, no or very little corrosion

L = limited resistance, exposure time must be limited, some corrosion might occur

U = unsatisfactory, not suitable for use



Green Pin® Master Link S/S-GR5

Grade 5 stainless steel master link

- **Material:** AISI 316L, grade 5
- **Safety factor:** MBL equals 4 x WLL
- **Finish:** polished
- **Temperature range:** -40°C up to +200°C
- **Certification:** 2.1 2.2 3.1 MTC[®]



MSI

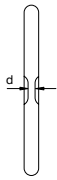
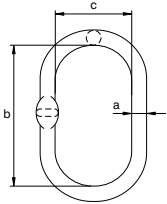

diameter	diameter chain 1 leg	diameter chain 2 legs		working load limit	length inside	width inside	thickness	weight each
a mm	mm	$\beta \leq 45^\circ$ mm	$\beta \leq 60^\circ$ mm	t	b mm	c mm	d mm	kg
13	6	6	6	1	110	60	6	0.34
16	8	6	8	1.25	110	60	6	0.53
18	10	8	10	2	135	75	8	0.82
22	13	10	13	3.2	160	90	10	1.45
26	16	13	16	5	180	100	13	2.29

In inch

diameter	diameter chain 1 leg	diameter chain 2 legs		working load limit	length inside	width inside	thickness	weight each
a inch	inch	$\beta \leq 45^\circ$ inch	$\beta \leq 60^\circ$ inch	t	b inch	c inch	d inch	lbs
$\frac{1}{2}$	$\frac{7}{32}$	$\frac{7}{32}$	$\frac{7}{32}$	1	$4 \frac{11}{32}$	$2 \frac{3}{8}$	$\frac{1}{4}$	0.75
$\frac{5}{8}$	$\frac{5}{16}$	$\frac{7}{32}$	$\frac{5}{16}$	1.25	$4 \frac{11}{32}$	$2 \frac{3}{8}$	$\frac{1}{4}$	1.17
$\frac{23}{32}$	$\frac{3}{8}$	$\frac{5}{16}$	$\frac{3}{8}$	2	$5 \frac{5}{16}$	$2 \frac{15}{16}$	$\frac{5}{16}$	1.81
$\frac{7}{8}$	$\frac{1}{2}$	$\frac{3}{8}$	$\frac{1}{2}$	3.2	$6 \frac{5}{16}$	$3 \frac{3}{4}$	$\frac{13}{32}$	3.20
$1 \frac{1}{32}$	$\frac{5}{8}$	$\frac{1}{2}$	$\frac{5}{8}$	5	$7 \frac{3}{32}$	$3 \frac{15}{16}$	$\frac{9}{16}$	5.05



Green Pin® Master Link Assembly S/S-GR5

Grade 5 stainless steel master link assembly

- **Material:** AISI 316L, grade 5
- **Safety factor:** MBL equals 4 x WLL
- **Finish:** polished
- **Temperature range:** -40°C up to +200°C
- **Certification:** 2.1 2.2 3.1 MTC^b



MTSI

diameter	diameter chain 2 legs		working load limit	length inside	width inside	diameter	length inside	width inside	thickness	weight each
a mm	$\beta \leq 45^\circ$ mm	$\beta \leq 60^\circ$ mm	t	b mm	c mm	d mm	e mm	f mm	g mm	kg
18	6	6	1.6	135	75	13	54	25	6	1.17
22	8	8	2.65	160	90	16	70	34	8	2.17
26	10	10	4.25	180	100	18	85	40	8	3.34
32	13	13	6.7	200	110	22	115	50	13	5.99

In inch

diameter	diameter chain 2 legs		working load limit	length inside	width inside	diameter	length inside	width inside	thickness	weight each
a inch	$\beta \leq 45^\circ$ inch	$\beta \leq 60^\circ$ inch	t	b inch	c inch	d inch	e inch	f inch	g inch	lbs
$\frac{23}{32}$	$\frac{7}{32}$	$\frac{7}{32}$	1.6	$5 \frac{5}{16}$	$2 \frac{15}{16}$	$\frac{1}{2}$	$2 \frac{1}{8}$	$\frac{31}{32}$	$\frac{1}{4}$	2.58
$\frac{7}{8}$	$\frac{5}{16}$	$\frac{5}{16}$	2.65	$6 \frac{5}{16}$	$3 \frac{17}{32}$	$\frac{5}{8}$	$2 \frac{3}{4}$	$1 \frac{11}{32}$	$\frac{5}{16}$	4.78
$1 \frac{1}{32}$	$\frac{3}{8}$	$\frac{3}{8}$	4.25	$7 \frac{3}{32}$	$3 \frac{15}{16}$	$\frac{23}{32}$	$3 \frac{11}{32}$	$1 \frac{9}{16}$	$\frac{5}{16}$	7.36
$1 \frac{1}{4}$	$\frac{1}{2}$	$\frac{1}{2}$	6.7	$7 \frac{7}{8}$	$4 \frac{11}{32}$	$\frac{7}{8}$	$4 \frac{17}{32}$	$1 \frac{31}{32}$	$\frac{1}{2}$	13.2

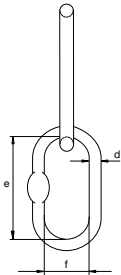
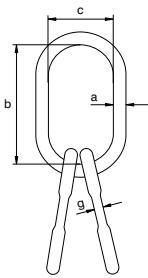



Green Pin® Omega Link S/S-GR5

Grade 5 stainless steel omega link

- **Material:** AISI 316L, grade 5
- **Safety factor:** MBL equals 4 x WLL
- **Finish:** polished
- **Temperature range:** -40°C up to +200°C
- **Certification:** 2.1 2.2 3.1



COI

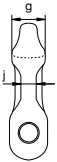
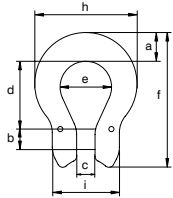

for chain diameter		working load limit	width	diameter pin	width	length inside	width bow	length outside	thickness	width outside	width outside	thickness	weight each
mm	inch	t	a mm	b mm	c mm	d mm	e mm	f mm	g mm	h mm	i mm	j mm	kg
5	³ / ₁₆	0.5	14	6	7	26	20	53	13	41	28	6	0.07
6	⁷ / ₃₂	0.7	14	8	7	25	20	53	13	41	28	6	0.07
7 - 8	¹ / ₄ - ⁵ / ₁₆	1.2	20	9	9	34	24	71	16	55	32	8	0.18
10	³ / ₈	1.6	19	13	12	40	31	82	17	63	42	11	0.28
13	¹ / ₂	2.7	25	16	15	51	40	106	20	84	54	14	0.64



Green Pin® Connecting Link S/S-GR5

Grade 5 stainless steel connecting link

- **Material:** AISI 316L, grade 5
- **Safety factor:** MBL equals 4 x WLL
- **Finish:** polished
- **Temperature range:** -40°C up to +200°C
- **Certification:** 2.1 2.2 3.1



MJI

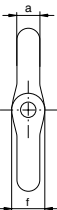
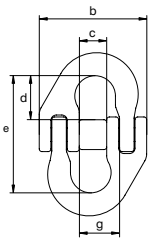

for chain diameter		working load limit	diameter	width outside	width inside	length inside	length inside	diameter eye	width inside	weight each
mm	inch	t	a mm	b mm	c mm	d mm	e mm	f mm	g mm	kg
6	⁷ / ₃₂	0.7	8	42	11	20	52	11	15	0.09
7 - 8	¹ / ₄ - ⁵ / ₁₆	1.2	9	53	14	20	55	13	19	0.16
10	³ / ₈	1.6	10	66	18	23	64	18	23	0.28
13	¹ / ₂	2.7	14	83	21	32	85	24	28	0.64

INFO



Green Pin® Sling Hook E S/S-GR5

Grade 5 stainless steel eye sling hook

- **Material:** AISI 316L, grade 5
- **Safety factor:** MBL equals 4 x WLL
- **Finish:** polished
- **Temperature range:** -40°C up to +200°C
- **Certification:** 2.1 2.2 3.1 MPI[®]



CSOI

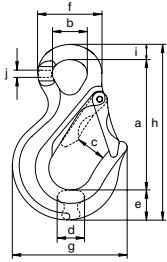

for chain diameter		working load limit	length	diameter inside eye	width opening	thickness	width	diameter eye outside	width outside	length	width	thickness	weight each
mm	inch												
6	7/32	0.7	84	23	26	15	20	43	72	114	10	6	0.28
7 - 8	1/4 - 5/16	1.2	103	26	30	20	24	51	87	139	12	8	0.56
10	3/8	1.6	128	35	33	24	29	65	106	172	15	10	1.09
13	1/2	2.7	152	41	37	32	39	77	133	209	18	12	1.98



Green Pin® Sling Hook CL S/S-GR5

Grade 5 stainless steel clevis sling hook

- **Material:** AISI 316L, grade 5
- **Safety factor:** MBL equals 4 x WLL
- **Finish:** polished
- **Temperature range:** -40°C up to +200°C
- **Certification:** 2.1 2.2 3.1 MPI[®]



CSCI

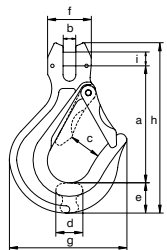

for chain diameter		working load limit	length	width	width opening	thickness	width	width outside	width outside	length	diameter pin	weight each
mm	inch											
5	3/16	0.5	76	7	26	15	20	28	72	108	6	0.29
6	7/32	0.7	75	7	26	15	20	28	72	108	8	0.29
7 - 8	1/4 - 5/16	1.2	95	9	30	20	24	32	87	136	9	0.58
10	3/8	1.6	113	12	33	24	29	42	106	164	13	1.1
13	1/2	2.7	138	15	37	32	39	54	133	208	16	1.86



Green Pin® Sling Hook S S/S-GR5

Grade 5 stainless steel swivel sling hook

- **Material:** AISI 316L, grade 5
- **Safety factor:** MBL equals 4 x WLL
- **Finish:** polished
- **Temperature range:** -40°C up to +200°C
- **Certification:** 2.1 2.2 3.1 MPI^b
- **Note:** equipped with a stainless steel washer



CSEI

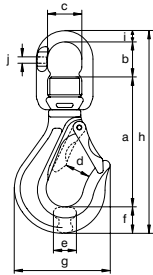

for chain diameter		working load limit	length	length inside	width inside	width opening	thickness	width	width outside	length outside	diameter	thickness	weight each
mm	inch	t	a mm	b mm	c mm	d mm	e mm	f mm	g mm	h mm	i mm	j mm	kg
6	7/32	0.7	100	33	32	26	15	20	72	164	12	6	0.55
7 - 8	1/4 - 5/16	1.2	126	40	37	30	20	24	87	200	14	8	1
10	3/8	1.6	159	47	47	33	24	29	106	250	16	11	1.9
13	1/2	2.7	189	59	58	37	32	39	133	307	21	14	3.42



Green Pin® Grab Hook E S/S-GR5

Grade 5 stainless steel eye grab hook

- **Material:** AISI 316L, grade 5
- **Safety factor:** MBL equals 4 x WLL
- **Finish:** polished
- **Temperature range:** -40°C up to +200°C
- **Certification:** 2.1 2.2 3.1 MPI^b



CROI

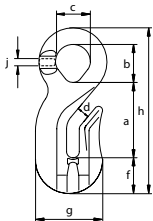

for chain diameter		working load limit	length	inside length eye	inside width eye	opening	thickness	width	width outside	length	width	thickness	weight each
mm	inch	t	a mm	b mm	c mm	d mm	e mm	f mm	g mm	h mm	i mm	j mm	kg
6	7/32	0.7	41	24	23	8	24	20	42	94	9	6	0.25
7 - 8	1/4 - 5/16	1.2	53	27	26	10	33	23	53	115	10	8	0.32
10	3/8	1.6	65	38	36	12	40	29	66	146	14	10	0.53
13	1/2	2.7	83	42	41	15	56	40	88	183	16	12	1.96

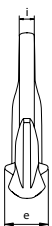



Green Pin® Lifting Eye S/S-GR5

Grade 5 stainless steel lifting eye

- **Material:** AISI 316L, grade 5
- **Safety factor:** MBL equals 5 x WLL
- **Finish:** polished
- **Temperature range:** -40°C up to +200°C
- **Certification:** 2.1 2.2 3.1 MPI[®] CE



ALI

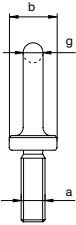
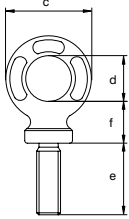

working load limit	diameter thread	diameter base	diameter eye outside	diameter eye inside	length	thickness base	diameter	weight each
t	a mm	b mm	c mm	d mm	e mm	f mm	g mm	kg
0.12	M6 x 1.00	20	34	20	20	17	7	0.05
0.2	M8 x 1.25	20	34	20	24	17	7	0.05
0.4	M10 x 1.50	20	38	22	30	19	8	0.08
0.6	M12 x 1.75	25	47	27	36	23	10	0.14
0.8	M14 x 2.00	30	57	30	40	27	14	0.26
1	M16 x 2.00	36	63	35	53	31	14	0.37
1.5	M18 x 2.50	36	63	35	53	31	14	0.49
2	M20 x 2.50	40	72	40	58	34	16	0.55
2.5	M22 x 2.50	42	82	45	64	38	19	0.78
3	M24 x 3.00	55	95	55	84	40	20	1.12



Green Pin® Lifting Eye DIN580 length S/S-GR5

Grade 5 stainless steel lifting eye length as DIN580

- **Material:** AISI 316L, grade 5
- **Safety factor:** MBL equals 5 x WLL
- **Finish:** polished
- **Temperature range:** -40°C up to +200°C
- **Certification:** 2.1 2.2 3.1 MPI[®] CE



ALDINI

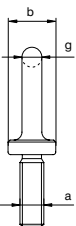
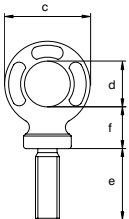

working load limit	diameter thread	diameter base	diameter eye outside	diameter eye inside	length	thickness base	diameter	weight each
t	a mm	b mm	c mm	d mm	e mm	f mm	g mm	kg
0.2	M8 x 1.25	20	34	20	13	17	7	0.05
0.4	M10 x 1.50	20	38	22	17	19	8	0.08
0.6	M12 x 1.75	25	47	27	21	23	10	0.14
0.8	M14 x 2.00	30	57	30	27	27	14	0.26
1	M16 x 2.00	36	63	35	27	31	14	0.37
1.5	M18 x 2.50	36	63	35	30	31	14	0.49
2	M20 x 2.50	40	72	40	30	34	16	0.55
2.5	M22 x 2.50	42	82	45	36	38	19	0.78
3	M24 x 3.00	55	95	55	36	40	20	1.12



Green Pin® Eye Nut S/S-GR5

Grade 5 stainless steel eye nut

- **Material:** AISI 316L, grade 5
- **Safety factor:** MBL equals 5 x WLL
- **Finish:** polished
- **Temperature range:** -40°C up to +200°C
- **Certification:** 2.1 2.2 3.1 MPI¹ CE



ELI

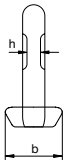
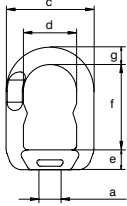

working load limit	diameter thread	diameter base	width	width inside	thickness base	length inside	diameter	thickness	weight each
t	a mm	b mm	c mm	d mm	e mm	f mm	g mm	h mm	kg
0.12	M6 x 1.00	31	51	30	14	44	11	6	0.15
0.2	M8 x 1.25	31	51	30	14	44	11	6	0.15
0.4	M10 x 1.50	31	51	30	14	44	11	6	0.15
0.6	M12 x 1.75	39	56	32	15	48	12	6	0.23
0.8	M14 x 2.00	39	56	32	15	48	12	6	0.23
1	M16 x 2.00	44	65	37	17	60	14	8	0.37
1.5	M18 x 2.50	44	65	37	17	60	14	8	0.37
2	M20 x 2.50	44	65	37	17	60	14	8	0.37
2.5	M22 x 2.50	52	79	48	21	75	16	11	0.63
3	M24 x 3.00	52	79	48	21	75	16	11	0.63
3.5	M27 x 3.00	52	79	48	21	75	16	11	0.63



Green Pin® Weld-On Transport Ring S/S-GR5

Grade 5 stainless steel weld-on transport ring

- **Material:** AISI 316, grade 5
- **Safety factor:** MBL equals 4 x WLL
- **Finish:** polished
- **Temperature range:** -40°C up to +200°C
- **Certification:** 2.1 2.2 3.1 CE
- **Note:** regarding the selection of welding material, respecting parent and PASI materials, please refer to EN 3581 for manual metal arc welding and to EN ISO 14343 for arc welding



PASI

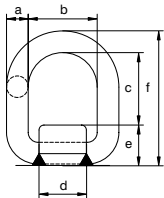

working load limit	diameter	width inside	length inside	length base	height base	length	weight each
t	a mm	b mm	c mm	d mm	e mm	f mm	kg
0.75	13	40	42	35	28	83	0.4
1.25	18	45	48	42	33	99	0.8
3.2	22	55	57	49	42	121	1.4
5	26	70	67	64	50	143	2.5

INFO



Green Pin® ID Tag S/S-GR5

Grade 5 stainless steel identification tag

- **Material:** AISI 316, grade 5
- **Finish:** polished
- **Certification:** 2.1



TAGI

width	length	length	weight each
a mm	b mm	c mm	kg
50	80	305	0.07

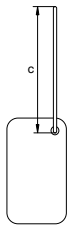
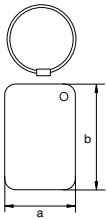

Green Pin® Clevis Fittings S/S-GR5 Spare Kit

Grade 5 stainless steel spare kit for clevis fittings

- **Material:** AISI 316L, grade 5
- **Finish:** polished
- **Temperature range:** -40°C up to +200°C
- **Certification:** 2.1 3.1

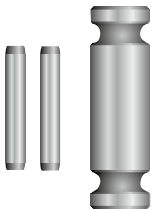

ACI

partnumber	diameter pin	length pin	diameter pin	length pin	weight each
	a mm	b mm	c mm	d mm	kg
GPAC5I	6	28	3	14	0.01
GPAC6I	8	28	3	14	0.01
GPAC7/8I	9	32	3	22	0.02
GPAC10I	13	41	4	24	0.04
GPAC13I	16	53	4	32	0.08

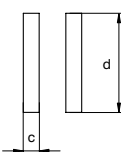
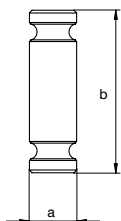

partnumber	for fitting	
	COI	CSCI
GPAC5I	GPCO5I	GPCSC5I
GPAC6I	GPCO6I	GPCSC6I
GPAC7/8I	GPCO7/8I	GPCSC7/8I
GPAC10I	GPCO10I	GPCSC10I
GPAC13I	GPCO13I	GPCSC13I



Green Pin® Connecting Link S/S-GR5 Spare Kit

Grade 5 stainless steel spare kit for connecting link

- **Material:** AISI 316L, grade 5
- **Finish:** polished
- **Temperature range:** -40°C up to +200°C
- **Certification:** 2.1 3.1

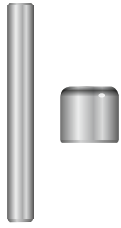

RMJI

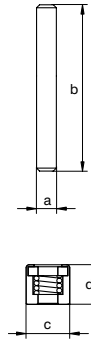

partnumber	diameter pin	length pin	diameter	width	weight each
	a mm	b mm	c mm	d mm	kg
GPRMJ6I	5	43	11	10	0.01
GPRMJ7/8I	6	54	13	14	0.02
GPRMJ10I	8	66	15	18	0.02
GPRMJ13I	10	84	20	21	0.08

partnumber	for fitting
	MJI
GPRMJ6I	GPMJ6I
GPRMJ7/8I	GPMJ7/8I
GPRMJ10I	GPMJ10I
GPRMJ13I	GPMJ13I



Green Pin® Latch S/S-GR5

Grade 5 stainless steel forged latch

- **Material:** AISI 316L, grade 5
- **Finish:** polished
- **Temperature range:** -40°C up to +200°C
- **Certification:** 2.1

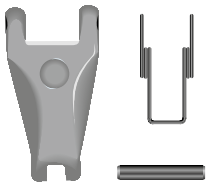

LF1

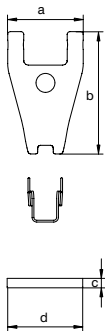

partnumber	width	length	diameter pin	length pin	weight each
	a mm	b mm	c mm	d mm	kg
LF0I	24	44	4	24	0.04
LF1I	31	59	5	30	0.05
LF2I	41	65	5	40	0.1
LF3I	41	79	6	40	0.2

partnumber	for fitting		
	CDOI	CSCI	CSEI
LF0I	GPCSO6I	GPCSC5I	GPCSE6I
LF1I	GPCSO7/8I	GPCSC7/8I	GPCSE7/8I
LF2I	GPCSO10I	GPCSC10I	GPCSE10I
LF3I	GPCSO13I	GPCSC13I	GPCSE13I



Green Pin® Lifting Chain S/S-GR5

Grade 5 stainless steel lifting chain

- **Material:** AISI 316L, grade 5
- **Safety factor:** MBL equals 4 x WLL
- **Finish:** polished
- **Temperature range:** -40°C up to +200°C
- **Certification:** 2.1 2.2 3.1 MTC^b



CHAINI

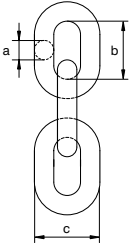

diameter		working load limit t	length inside	width outside	links per meter	length per drum	weight per meter
a mm	inch		b mm	c mm		m	kg
6	7/32	0.7	18	21	55.56	100	0.78
8	5/16	1.2	24	29	41.67	100	1.3
10	3/8	1.6	30	34	33.33	100	2.14
13	1/2	2.7	39	45	25.64	100	3.64

C

Stainless steel bow shackle with screw pin



MLVI

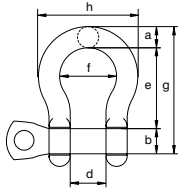

- **Material:** AISI 316, grade 5
- **Safety factor:** MBL equals 5 x WLL
- **Finish:** polished
- **Temperature range:** -40°C up to +200°C
- **Certification:** 2.1 2.2 3.1 CE
- **Note:** marked with WLL and CE

working load limit	diameter bow	diameter pin	diameter eye	width inside	length inside	width bow	length	width	weight each
t	a mm	b mm	c mm	d mm	e mm	f mm	g mm	h mm	kg
0.4	8	8	16	16	32	25	56	41	0.06
0.6	10	10	19	20	40	28	67	48	0.12
0.9	12	12	24	25	48	36	79	59	0.2
1.5	13	16	31	24	52	35	87	60	0.32
2.5	16	20	38	28	64	42	108	71	0.58
3	19	22	44	32	72	50	125	87	0.96
4	22	25	50	37	74	60	145	101	1.46
6	25	30	57	40	94	67	157	115	2.09

C

Stainless steel dee shackle with screw pin



MDVI

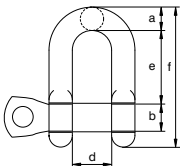

- **Material:** AISI 316, grade 5
- **Safety factor:** MBL equals 5 x WLL
- **Finish:** polished
- **Temperature range:** -40°C up to +200°C
- **Certification:** 2.1 2.2 3.1 CE
- **Note:** marked with WLL and CE

working load limit	diameter bow	diameter pin	diameter eye	width inside	length inside	length	weight each
t	a mm	b mm	c mm	d mm	e mm	f mm	kg
0.4	8	8	16	16	32	52	0.06
0.6	10	10	19	20	40	64	0.11
0.9	12	12	24	25	48	78	0.19
1.5	13	16	31	24	52	90	0.3
2.5	16	20	38	28	64	110	0.57
3	19	22	44	32	72	124	0.9
4	22	25	50	37	74	134	1.33
6	25	30	57	40	94	162	1.98

C

Shackles, bow shackles with screw pin

Bow shackles with screw pin



R-7825

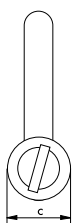
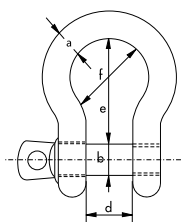

- **Material:** AISI 316
- **Safety factor:** MBL equals 6 x WLL
- **Standard:** generally to DIN 82103
- **Finish:** polished
- **Certification:** 2.1 2.2 3.1 CE
- **Note:** marked with WLL, CE and manufacturer identification symbol (VBS), except for 4 mm as it is too small

working load limit	diameter bow	diameter pin	diameter eye	width inside	length inside	width bow	weight per 100 pcs
t	a mm	b mm	c mm	d mm	e mm	f mm	kg
-	4	4	8	8	16	12	1.2
0.12	5	5	10	10	20	15	1.8
0.15	6	6	12	12	24	18	2.7
0.3	8	8	16	16	32	24	6.3
0.4	10	10	20	20	40	30	12.3
0.6	12	12	24	24	48	36	20.5
1	16	16	32	32	64	48	48
1.5	20	20	40	40	80	60	97
2	22	22	44	44	88	66	146
3	25	25	50	50	100	75	211
3.6	28	28	54	56	116	86	285

C

Shackles, bow shackles with safety bolt

Bow shackles with safety bolt

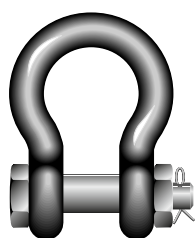

R-7827

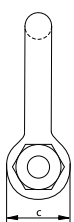
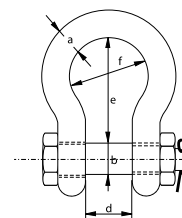

- **Material:** AISI 316
- **Safety factor:** MBL equals 6 x WLL
- **Finish:** polished
- **Certification:** 2.1 2.2 3.1 CE
- **Note:** marked with WLL, CE, traceability code and manufacturer identification symbol (VBS)

working load limit	diameter bow	diameter pin	diameter eye	width inside	length inside	width bow	weight per 100 pcs
t	a mm	b mm	c mm	d mm	e mm	f mm	kg
0.3	8	8	16	16	32	24	7.4
0.4	10	10	19	20	40	30	14.5
0.6	12	12	24	25	49	36	23
1	16	16	31	32	64	48	56.6
1.5	19	19	38	38	80	60	99.5
2	22	22	43	44	85	66	146
3	25	25	49	50	100	75	218

C



R-7821

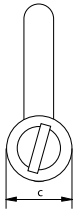
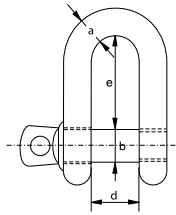

Shackles, dee shackles with screw pin

Dee shackles with screw pin

- **Material:** AISI 316
- **Safety factor:** MBL equals 6 x WLL
- **Standard:** generally to DIN 82102
- **Finish:** polished
- **Certification:** 2.1 2.2 3.1 CE
- **Note:** marked with WLL, CE and manufacturer identification symbol (VBS), except for 4 mm as it is too small

working load limit	diameter bow	diameter pin	diameter eye	width inside	length inside	weight per 100 pcs
t	a mm	b mm	c mm	d mm	e mm	kg
-	4	4	8	8	16	0.9
0.12	5	5	10	10	20	1.6
0.15	6	6	12	12	24	2.6
0.3	8	8	16	16	32	5.6
0.4	10	10	20	20	40	13
0.6	12	12	24	24	48	20
1	16	16	32	32	64	48
1.5	20	20	40	40	80	78
2	22	22	44	44	88	127
3	25	25	50	50	100	184
3.6	28	28	54	56	106	250

C



R-7823

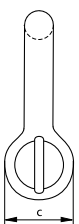
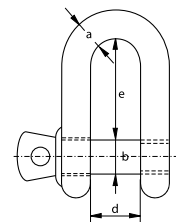

Shackles, dee shackles with safety bolt

Dee shackles with safety bolt

- **Material:** AISI 316
- **Safety factor:** MBL equals 6 x WLL
- **Finish:** polished
- **Certification:** 2.1 2.2 3.1 CE
- **Note:** marked with WLL, CE, traceability code and manufacturer identification symbol (VBS)

working load limit	diameter bow	diameter pin	diameter eye	width inside	length inside	weight per 100 pcs
t	a mm	b mm	c mm	d mm	e mm	kg
0.3	8	8	16	16	32	7.1
0.4	10	10	19	20	40	14
0.6	12	12	24	25	48	23.6
1	16	16	31	32	64	54.5
1.5	19	19	38	38	76	96
2	22	22	43	44	85	142
3	25	25	49	50	95	209

C

Thimbles, heavy type

- Material: AISI 316
- Finish: polished
- Certification: 2.1



R-7860

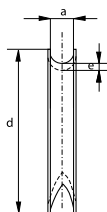
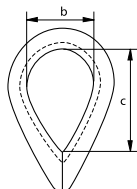

width groove	width inside	length inside	length	thickness	weight per 100 pcs
a mm	b mm	c mm	d mm	e mm	kg
2	9	15	23	1	0.2
2.5	9.5	15.7	24	1	0.2
3	10	16	25	1	0.3
4	11	17	28	1	0.5
5	13	20	32	1	0.5
6	16	25	39	1.2	0.8
7	18	28	40	1.2	1
8	20	32	49	1.4	1.2
10	26	40	55	1.9	3.4
12	28	45	70	2	4.5
14	34	56	80	2.2	7.3
16	37	62	85	2.5	12.2
18	42	65	95	2.5	15.1
20	45	78	115	3	19
22	50	88	125	3	22.3
24	58	96	135	4	40.5
26	66	105	140	4	49.7

C

Wire rope clips

Generally to DIN 741

- Material: AISI 316
- Standard: generally to DIN 741
- Finish: polished
- Certification: 2.1



R-7863

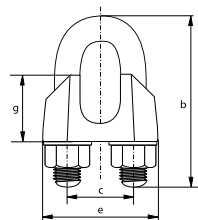

diameter wire rope	diameter	length bow	width inside	length thread	length base	thickness base	height base	weight per 100 pcs
mm	a mm	b mm	c mm	d mm	e mm	f mm	g mm	kg
3	4	20	9	12	21	10	10	1.4
4	4	22	9	12	21	10	10	1.4
5	5	24	11	13	23	11	10	1.5
6	5	28	13	15	26	12	11	2.1
8	6	34	16	19	30	14	15	3.5
10	8	42	19	22	34	18	17	6.1
13	10	55	24	30	42	23	21	13
16	12	63	29	33	50	26	26	21
19	12	75	32	38	54	29	30	26
22	14	85	37	44	61	33	34	40
26	14	95	41	45	65	35	37	44

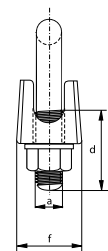



Open body rigging screws Hook-Hook

- Material: AISI 316
- Finish: polished
- Certification: 2.1



R-7837

diameter thread	length closed position	length open position	length body	length	length	length	opening hook	thickness	weight each
a mm	b mm	c mm	d mm	e mm	f mm	g mm	h mm	h mm	kg
M 5	120	170	70	58	33	8	5	0.04	
M 6	150	210	90	73	43	9	6	0.08	
M 8	200	290	120	98	56	11	8	0.16	
M 10	240	355	150	117	71	12	9	0.27	
M 12	310	470	200	157	95	14	11	0.51	
M 16	390	590	250	186	116	16	15	1.2	
M 20	440	675	300	214	139	18	19	1.9	

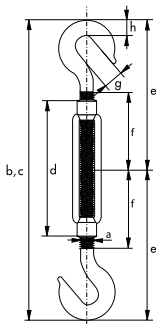

Open body rigging screws Hook-Eye

- Material: AISI 316
- Finish: polished
- Certification: 2.1



R-7838

diameter thread	length closed position	length open position	length body	length	length	length	length	opening hook	thickness	diameter eye outside	diameter eye inside	weight each
a mm	b mm	c mm	d mm	e mm	f mm	g mm	h mm	i mm	j mm	k mm	kg	
M 5	120	170	70	58	56	33	8	5	17	8	0.04	
M 6	150	210	90	73	71	43	9	6	21	10	0.08	
M 8	200	290	120	98	95	56	11	8	28	14	0.16	
M 10	240	355	150	117	118	71	12	9	34	16	0.27	
M 12	310	470	200	157	154	95	14	11	40	18	0.51	
M 16	390	590	250	186	190	116	16	15	54	26	1.2	
M 20	440	675	300	214	220	139	18	19	64	30	1.9	

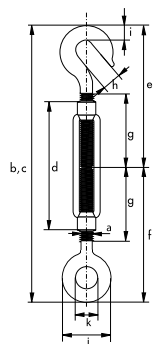

C

Open body rigging screws Eye-Eye

- Material: AISI 316
- Finish: polished
- Certification: 2.1



R-7839

diameter thread	length closed position	length open position	length body	length	length	diameter eye outside	diameter eye inside	weight each
a mm	b mm	c mm	d mm	e mm	f mm	g mm	h mm	kg
M 5	120	170	70	56	33	17	8	0.04
M 6	150	210	90	71	43	21	10	0.08
M 8	200	290	120	95	56	28	14	0.16
M 10	240	355	150	118	71	34	16	0.27
M 12	310	470	200	154	95	40	18	0.51
M 16	390	590	250	190	116	54	26	1.2
M 20	440	675	300	220	139	64	30	1.9

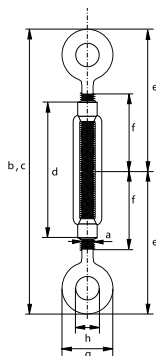

C

Closed body rigging screws Jaw-Jaw

- Material: AISI 316
- Finish: polished
- Certification: 2.1



R-7830

diameter thread	length open	length closed	length body	diameter pin	width jaw inside	weight per 100 pcs
a mm	b mm	c mm	d mm	e mm	f mm	kg
M 5	190	125	80	5.2	6	6.5
M 6	210	155	95	6.2	7.5	8.1
M 8	240	180	105	8.7	10	15.9
M 10	270	220	125	9.7	12	29.9
M 12	360	255	150	12.7	14	53.2
M 14	385	270	165	12.7	14	64
M 16	450	320	190	16	16	116
M 20	450	355	210	19	20	145

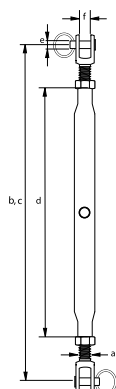

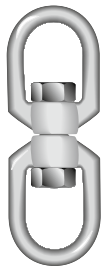

R-7877

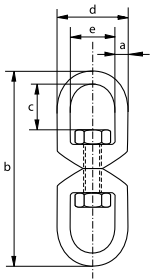

Swivels

Eye - Eye

- Material: AISI 316
- Finish: polished
- Certification: 2.1

diameter	length	length inside	width outside	width inside	weight per 100 pcs
a mm	b mm	c mm	d mm	e mm	kg
5	60	13	23	13	3.4
6	65	15	26	15	5.1
8	90	22	35	20	13.1
10	115	27	44	24	26
13	154	35	57	32	58
16	188	45	71	39	105
19	229	50	84	41	220

C

Eye bolts

Generally to DIN 580



- **Material:** AISI 316
- **Standard:** generally to DIN 580
- **Finish:** polished
- **Certification:** 2.1

R-7840

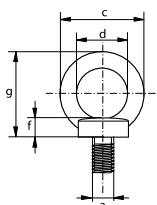

diameter thread	diameter base	diameter eye outside	diameter eye inside	length thread	thickness base	height	weight per 100 pcs
a mm	b mm	c mm	d mm	e mm	f mm	g mm	kg
M 6	20	36	20	13	6	36	3
M 8	20	36	20	13	6	36	6
M 10	25	45	25	17	8	45	10.3
M 12	30	54	30	20.5	10	53	17.7
M 16	35	63	35	27	12	62	28
M 20	40	72	40	30	14	71	45
M 24	50	90	50	36	18	90	74

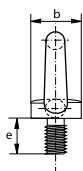

C

Eye nuts

Generally to DIN 582



- **Material:** AISI 316
- **Standard:** generally to DIN 582
- **Finish:** polished
- **Certification:** 2.1

R-7842

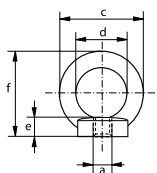

diameter thread	diameter base	diameter eye outside	diameter eye inside	thickness base	height	weight per 100 pcs
a mm	b mm	c mm	d mm	e mm	f mm	kg
M 6	20	36	20	8.5	36	4.2
M 8	20	36	20	8.5	36	5.2
M 10	25	45	25	10	45	9.4
M 12	30	54	30	11	53	14.8
M 16	35	63	35	13	62	23.7

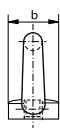

C

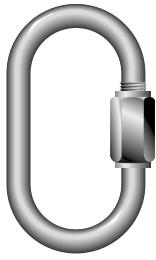

R-7873

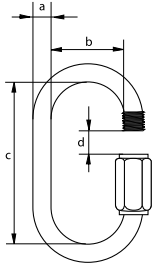

Quick links, standard type

- Material: AISI 316
- Finish: polished
- Certification: 2.1

diameter	width inside	length inside	opening	minimum breaking load	weight per 100 pcs
a mm	b mm	c mm	d mm	kg	kg
3.5	10	29	5	155	0.9
4	12	32	5.5	450	1.2
5	13	39	6.5	585	2
6	14	46	7.5	790	3.3
7	16	51	8.5	1085	5.3
8	17	59	10.5	1380	7.5
9	17	64	11.5	1790	10.3
10	20	70	12.5	2085	13.7
12	23	83	14.5	2265	22.5

C

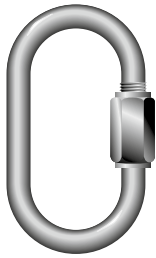

R-7874

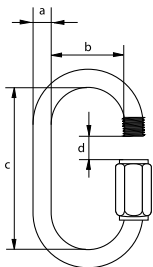

Quick links, with enlarged opening

- Material: AISI 316
- Finish: polished
- Certification: 2.1

diameter	width inside	length inside	opening	minimum breaking load	weight per 100 pcs
a mm	b mm	c mm	d mm	kg	kg
3.5	10	40	10	155	1.2
5	14	52	14	585	2.6
6	16	60	16	790	4
8	18	74	18	1380	9.1
10	20	85	20	2085	15.9
12	23	98	23	2265	30.4
14	27	116	26	2540	40.2

C

Carabine hooks, standard type

- Material: AISI 316
- Finish: polished
- Certification: 2.1

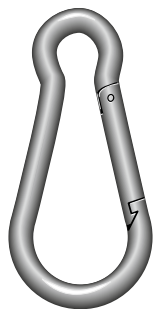

R-7872

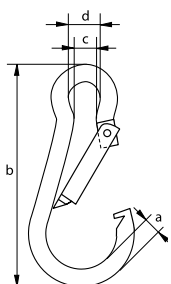

diameter	length	width inside	width inside	minimum breaking load	weight per 100 pcs
a mm	b mm	c mm	d mm	kg	kg
4	40	5	7	70	0.8
5	50	7	8	110	1.5
6	60	7	9	132	2.6
7	70	9	10	198	2.6
8	80	11	12	330	4.4
9	90	11	12	363	6.4
10	100	12	15	506	12.2
11	120	14	18	660	12.5
12	140	16	20	748	25
13	160	20	22	880	35
14	180	20	22	946	35

C

Carabine hooks, with pressed thimble

- Material: AISI 316
- Finish: polished
- Certification: 2.1

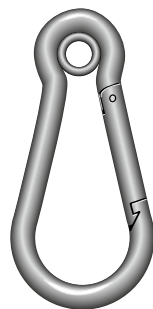

R-7875

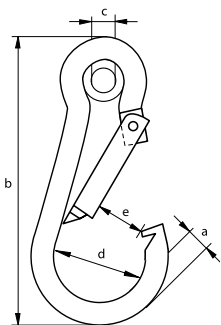

diameter	length	diameter inside thimble	width	minimum breaking load	weight per 100 pcs
a mm	b mm	c mm	d mm	kg	kg
4	40	5	14	70	0.9
5	50	5	16	110	1.6
6	60	5	18	132	2.8
7	70	7	22	198	4.4
8	80	10	24	330	6.4
9	90	10	26	363	9.3
10	100	13	30	506	12.5
11	120	13	36	660	18.7
12	140	15	40	748	25
13	160	17	44	880	35
14	180	17	48	946	50

C

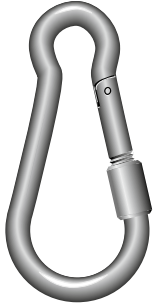

R-7876

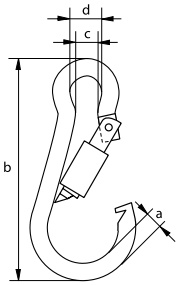

Carabine hooks, with screw nut

- Material: AISI 316
- Finish: polished
- Certification: 2.1

diameter	length	width inside	width inside	minimum breaking load	weight per 100 pcs
a mm	b mm	c mm	d mm	kg	kg
4	40	5	7	70	0.8
5	50	7	8	110	1.7
6	60	7	9	132	2.6
7	70	9	10	198	4.4
8	80	11	12	330	6.4
9	90	11	12	363	9.3
10	100	12	15	506	12.7
11	120	14	18	660	19.5
12	140	16	20	748	25
13	160	20	22	880	35
14	180	20	22	946	50

C

Cotter Pin

Stainless steel cotter pin

- Material: AISI 304
- Finish: polished
- Certification: 2.1

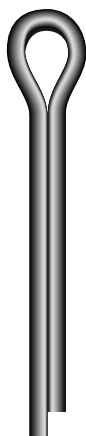

R-7856

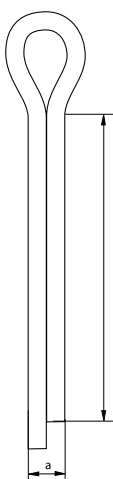

diameter	length	weight per 100 pcs
a mm	b mm	kg
2.5	20	0.08
4	32	0.3
5	36	0.6
6	45	1.2
8	63	2.8
8	80	4.4
10	71	5
10	90	6
10	100	6.6
10	120	4.4
12	140	7
12	160	7
12	180	7
13	110	12.1
16	160	16

split pin	for shackle									
	G-4163 G-4143	G-4153 G-4133	P-6036 P-6016 ≤150	G-6038 P-6018	P-6033 P-6013 ≤150	G-5263 G-5243	G-5163 G-5143	P-6031 P-6011 ≤150	G-4263 G-4243	G-4553
a x b mm	WLL t	WLL t	WLL t	WLL t	WLL t	WLL t	WLL t	WLL t	WLL t	WLL t
2.5 x 20	0.5									
	0.75									
	1									
	1.5									
4 x 32	2	2				3.3	2			
	3.25	3.25				5	3.25			
5 x 36	4.75	4.75			7	7	4.75		4.75	4.6
	6.5	6.5				9.5	6.5			
6 x 45	8.5	8.5			12.5	12.5	8.5		6.5	8.6
	9.5	9.5			18	15	9.5		8.5	
	12	12				18	12		9.5	
8 x 63	13.5	13.5				21	13.5		12	15.5
	17	17				30	17		16	
8 x 80					30					
					40					
10 x 71	25	25				40	25		25	
	35	35				55	35		30	
10 x 90	42.5	42.5				85	42.5		55	
	55	55					55			
10 x 100	85	85			55	120	85		75	
					75					
10 x 120					125					
12 x 140					150					
					200					
12 x 160					250					
12 x 180					300					
13 x 110			120	120		150		120		
			150			175		150		
16 x 160			200					200		
			250					250		
			300					300		

C

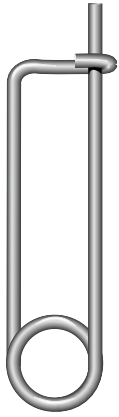

R-7850

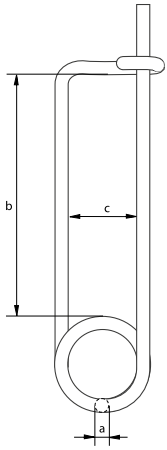

Safety Pin

Stainless steel safety pin

- Material: AISI 304 or 316
- Finish: polished
- Certification: 2.1

diameter	length inside	width inside	weight per 100 pcs
a mm	b mm	c mm	kg
2	46	18	0.5
3	66	23	1.8
3	116	24	2.5
3	147	24	2.8
4	74	29	3.9
5	95	22	6.9
6	90	39	12.5

safety pin	for shackle							
	G-4163	G-4153	P-6033	G-5263	G-5163	G-4263	G-4553	P-5367
a x b mm	WLL t	WLL t	WLL t	WLL t	WLL t	WLL t	WLL t	WLL t
2x46	4.75	4.75	7	7	4.75	4.75	4.6	
	6.5	6.5		9.5	6.5	6.5		
3x66	8.5	8.5	12.5	12.5	8.5	8.5	8.6	
	9.5	9.5	18	15	9.5	9.5		
	12	12		18	12	12		
3x116								12 - 55
3x147								85
								120
								150
4x74	13.5	13.5	30	21	13.5	16	15.5	
	17	17		30	17	25		
	25	25		40	25			
5x95	35	35	40	55	35	30		
	42.5	42.5	55		42.5			
6x90	55	55	75	85	55	55		
	85	85	125	120	85	75		

C

Single Spring Pin

Stainless steel single type spring pin

- Material: AISI 304
- Finish: polished
- Certification: 2.1

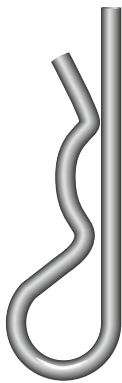

R-7852

diameter	length	diameter	diameter	weight per 100 pcs
a mm	b mm	c mm	d mm	kg
2	50	10	9 - 14	0.3
3	60	18	10 - 16	0.9
4	60	20	16 - 20	1.6
5	85	24	20 - 28	3.3
6	105	30	28 - 40	6.2
7	105	30	28 - 45	8.3
8	110	28	30 - 45	10.5

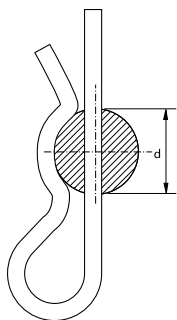
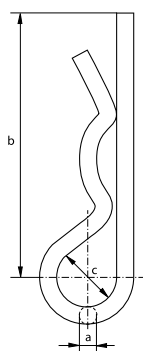

spring pin	for shackle						
	G-4163	G-4153	P-6033	G-5263	G-5163	G-4263	G-4553
diameter mm	WLL t	WLL t	WLL t	WLL t	WLL t	WLL t	WLL t
2	2	2		3.3	2		
3	3.25	3.25		5	3.25		
4	4.75	4.75	7	7	4.75	4.75	4.6
	6.5	6.5		9.5	6.5		
5	8.5	8.5	12.5	12.5	8.5	6.5	8.6
	9.5	9.5	18	15	9.5	8.5	
	12	12		18	12	9.5	
6	13.5	13.5		21	13.5	12	15.5
	17	17		30	17	16	
7	25	25	30	40	25	25	
			40				

C

Spring Pins

Stainless steel double type spring pin

- Material: AISI 304 or 316
- Finish: polished
- Certification: 2.1

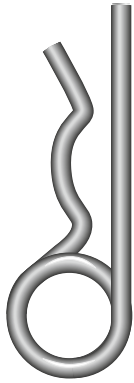

R-7854

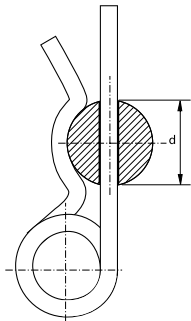
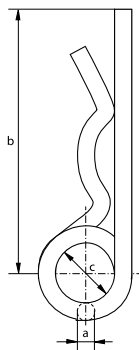

diameter	length	diameter	diameter	weight per 100 pcs
a mm	b mm	c mm	d mm	kg
2	50	10	8 - 14	0.4
3	62	16	14 - 20	1.4
3	80	15	18 - 30	2.5
4	78	23	17 - 24	3
4	110	21	24 - 45	3
4	120	21	45 - 56	3
4	150	27	45 - 56	3
5	92	26	18 - 30	5.3
6	120	30	24 - 36	9.6
7	130	30	24 - 40	13.5
8	130	30	24 - 45	17.8

spring pin	for shackle											
	G-4163	G-4153	P-6033	G-5263	G-5163	G-4263	G-4553	P-5363	P-5365	P-5367	P-5361D/F	P-5362D/F
a x b mm	WLL t	WLL t	WLL t	WLL t	WLL t	WLL t	WLL t	WLL t	WLL t	WLL t	WLL t	WLL t
2 x 50	2	2		3.3	2							
3 x 62	3.25	3.25		5	3.25				6.5~12		6.5	
3 x 80										12		
										13.5		
4 x 78	4.75	4.75	7	7	4.75	4.75	4.6	6.5	17			
	6.5	6.5		9.5	6.5		8.6		25			
	8.5	8.5		12.5	8.5				35			
4 x 110										17		
										25		
										35		
4 x 120										42.5		12~55
										55		
4 x 150										85		
										120		
										150		
5 x 92	9.5	9.5	12.5	15	9.5	6.5		9.5	42.5~85		9.5	
	12	12	18	18	12	8.5		12	120~250			
						9.5						
6 x 120	13.5	13.5		21	13.5	12	15.5	17			12	
	17	17		30	17	16					17	
											25	
8 x 130	25	25	30	40	25	25		25			35	
			40									

C

Short link chain

Generally to DIN 766 and DIN 5685-3

- **Material:** AISI 316
- **Standard:** generally to DIN 766 and DIN 5685-3
- **Certification:** [2.1](#)

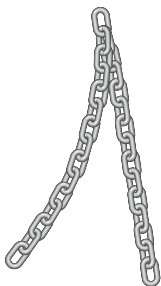

R-7880

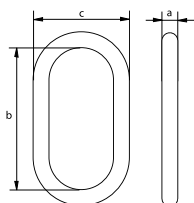

diameter	length inside	width outside	weight per meter
a mm	b mm	c mm	kg
3	16	11	0.17
4	16	14	0.32
5	18.5	17	0.5
6	18.5	20	0.75
8	24	26	1.35
10	28	34	2.25

C

Long link chain

Generally to DIN 763 and DIN 5685-1

- **Material:** AISI 316
- **Standard:** generally to DIN 763 and DIN 5685-1
- **Certification:** [2.1](#)

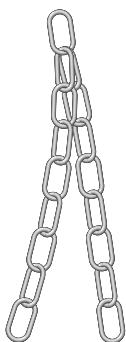

R-7890

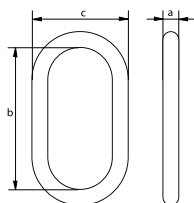

diameter	length inside	width outside	weight per meter
a mm	b mm	c mm	kg
3	26	12	0.14
4	32	16	0.27
5	36	20	0.43
6	42	24	0.63
7	48	28	0.86
8	54	32	1.1
10	66	40	1.75



GP

GreenPin

tycan

WLL 5T

TC: AQAC

Article code: FCHAIN1525

CE

CERTIFIED FOR LIFTING

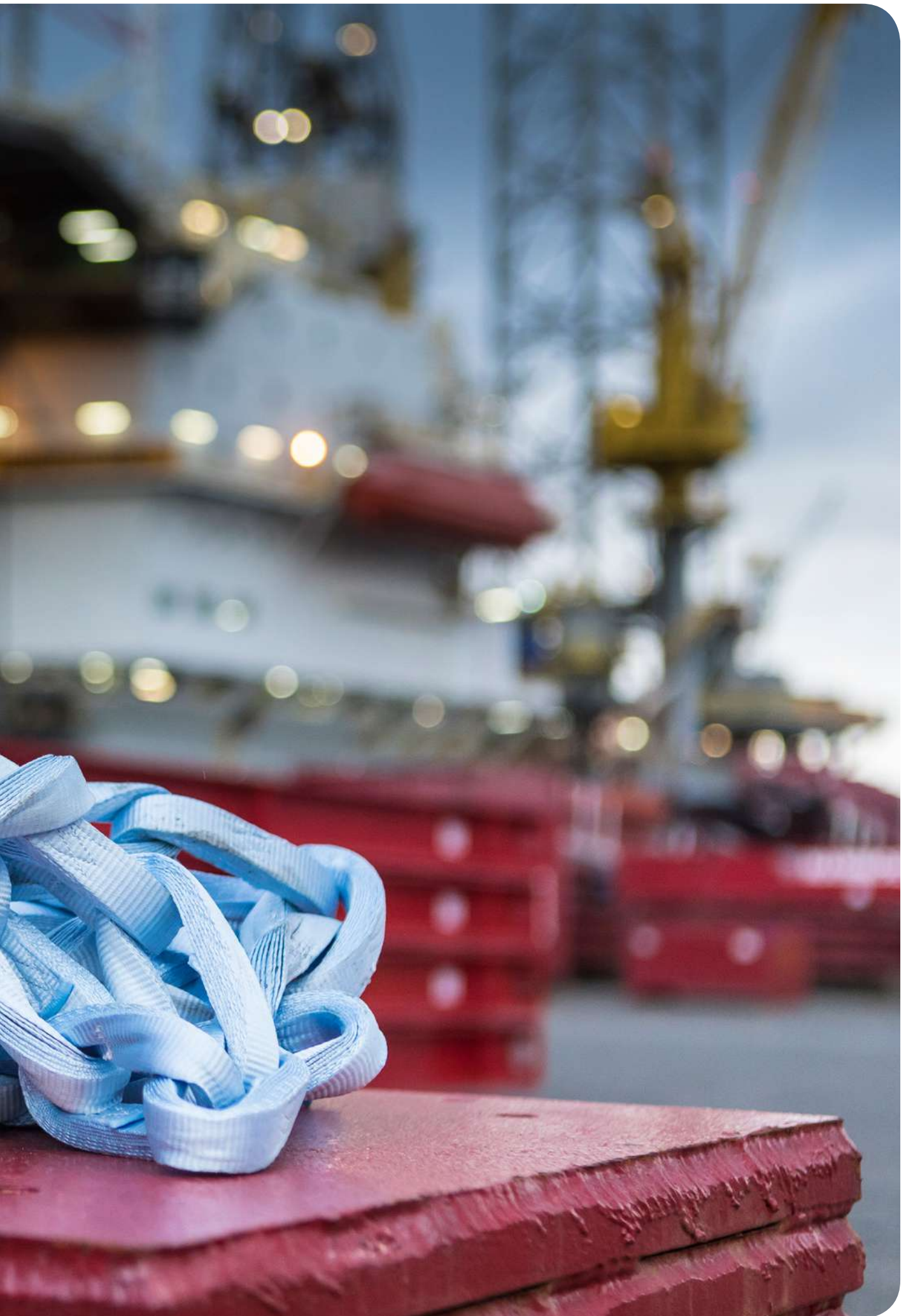



1	Shackles	
G-4161	Green Pin® Bow Shackle SC	28
G-4163	Green Pin® Bow Shackle BN	29
G-4143	Green Pin® Bow Shackle FN	30
G-4151	Green Pin® Dee Shackle SC	31
G-4153	Green Pin® Dee Shackle BN	32
G-4133	Green Pin® Dee Shackle FN	33
P-6036	Green Pin® Heavy Duty Bow Shackle BN	34
P-6016	Green Pin® Heavy Duty Bow Shackle FN	35
G-6038	Green Pin® Heavy Duty Dee Shackle BN	36
G-6018	Green Pin® Heavy Duty Dee Shackle FN	37
P-6033	Green Pin® Sling Shackle BN	38
P-6013	Green Pin® Sling Shackle FN	39
P-6043	Green Pin Power Sling® Shackle BN	40
G-5261	Green Pin Super® Bow Shackle SC	41
G-5263	Green Pin Super® Bow Shackle BN	42
G-5243	Green Pin Super® Bow Shackle FN	43
G-5163	Green Pin Polar® Bow Shackle BN	44
G-5143	Green Pin Polar® Bow Shackle FN	45
P-6031	Green Pin Polar® Heavy Duty Bow Shackle BN	46
P-6011	Green Pin Polar® Heavy Duty Bow Shackle FN	47
G-4263	Green Pin BigMouth® Bow Shackle BN	48
G-4243	Green Pin BigMouth® Bow Shackle FN	49
G-4553	Green Pin BigMouth® Dee Shackle BN	50
P-5363	Green Pin® Spring Pin ROV Shackle	51
P-5365	Green Pin® Locking Clamp ROV Shackle	52
P-5367	Green Pin® Spring Release ROV Shackle	53
P-5368	Green Pin® Compression Tool	54
P-5361D	Green Pin® Tapered Pin ROV Shackle D	55
P-5361F	Green Pin® Tapered Pin ROV Shackle F	56
P-5362D	Green Pin® Guided Pin ROV Shackle D	57
P-5362F	Green Pin® Guided Pin ROV Shackle F	58
P-5396D	Green Pin® D-handle	59
P-5396F	Green Pin® Fishtail handle	59
P-5461	Green Pin® Web Sling Shackle SC	60
P-4161T	Green Pin® Theatre Shackle SC	61
G-4164	Green Pin® Fishing Bow Shackle SQ	62
G-4154	Green Pin® Fishing Dee Shackle SQ	63
G-4169	Green Pin® Fishing Bow Shackle FP	64
E-4170	Green Pin® Sunken Hole Key	64
G-4159	Green Pin® Fishing Dee Shackle FP	65
E-4170	Green Pin® Sunken Hole Key	65
P-3764	Fishing Shackles – Bow shackle with square head screw pin	66
P-3754	Fishing Shackles – Dee shackle with square head screw pin	66
S-1165	Mooring Shackles – Bow shackle with screw pin	67
S-3351	Shackles generally to DIN 82101 type A	68
G-3351	Shackles generally to DIN 82101 type A	68
S-3352	Shackles generally to DIN 82101 type B	68
G-3352	Shackles generally to DIN 82101 type B	68
S-3356	Shackles generally to DIN 82101 type C	69
G-3356	Shackles generally to DIN 82101 type C	69
G-3161	Yellow Pin Shackles – Bow shackle with screw collar pin	70
G-3163	Yellow Pin Shackles – Bow shackle with safety bolt	70
G-3151	Yellow Pin Shackles – Dee shackle with screw collar pin	71
G-3153	Yellow Pin Shackles – Dee shackle with safety bolt	71
S-2751	Shackles generally to B.S. 3032 table 2	72
G-2751	Shackles generally to B.S. 3032 table 2	72
E-1161	Commercial Shackles – Bow shackle with screw collar pin	73
S-1164	Commercial Shackles – Bow shackle with square head screw pin	73
E-1162	Commercial Shackles – Bow shackle with counter sunk screw pin	74
E-1151	Commercial Shackles – Dee shackle with screw collar pin	74
S-1154	Commercial Shackles – Dee shackle with square head screw pin	75
2	Thimbles	
E-6110	Thimbles – Standard commercial	77
G-6120	Thimbles – Heavy duty stub-end	77
G-6128	Thimbles – Heavy duty stub-end reinforced with welded fillet plate	78
E-6131	Thimbles – Generally to DIN 6899 (B)	79
G-6131	Thimbles – Generally to DIN 6899 (B)	79
S-6134	Thimbles – According to DIN 3091	80
E-6135	Thimbles – Generally to DIN 3090	81
G-6135	Thimbles – Generally to DIN 3090	81
G-6170	Thimbles – Generally to EN 13411-1	82
G-6142	Thimbles – Generally to US Fed. Spec. FF-T-276b type III	83

G-6151.....	Thimbles – Pennant line type.....	84
P-6190.....	Thimbles – Tubular type.....	85
P-6195.....	Thimbles – Tubular type with welded plate.....	85
3	Wire Rope Clips	
G-6240.....	Green Pin® Wire Rope Clip.....	89
E-6260.....	Wire Rope Clip – Generally to EN 13411-5 Type A.....	90
E-6220.....	Wire Rope Clip – Generally to DIN 741.....	91
4	Sleeves	
S-6500.....	Prescon sleeves.....	93
A-6550.....	Aluminium sleeves.....	94
5	Sockets	
G-6411.....	Green Pin® Closed Spelter Socket.....	99
G-6412.....	Green Pin® Open Spelter Socket CP.....	100
G-6422.....	Green Pin® Open Spelter Socket BN.....	101
G-6413.....	Green Pin® Open Wedge Socket CP.....	102
G-6423.....	Green Pin® Open Wedge Socket BN.....	103
G-6416.....	Green Pin® Short Bow Socket.....	104
S-6414.....	Green Pin® Open Swage Socket CP.....	105
S-6415.....	Green Pin® Closed Swage Socket.....	106
6	Turnbuckles	
G-6313.....	Green Pin® JJ Turnbuckle CP.....	110
G-6323.....	Green Pin® JJ Turnbuckle BN.....	111
G-6333.....	Green Pin Polar® JJ Turnbuckle BN.....	113
G-6311.....	Green Pin® EE Turnbuckle.....	114
G-6312.....	Green Pin® HH Turnbuckle.....	116
G-6315.....	Green Pin® EJ Turnbuckle.....	117
G-6314.....	Green Pin® EH Turnbuckle.....	119
E-6351.....	Rigging screws Eye-Eye.....	120
E-6352.....	Rigging screws Hook-Hook.....	120
E-6354.....	Rigging screws Eye-Hook.....	121
E-6353.....	Rigging screws Jaw-Jaw.....	121
E-6355.....	Rigging screws with Welding Ends.....	122
S-6330.....	Turnbuckles (hamburgers).....	123
G-6343.....	Closed body rigging screws Jaw-Jaw.....	124
G-6340.....	Closed body rigging screws Eye-Eye.....	124
G-6345.....	Closed body rigging screws Eye-Jaw.....	125
7	Links	
MS.....	Green Pin® Master Link EN 1677-4 GR8.....	128
MTS.....	Green Pin® Master Link Assembly EN 1677-4 GR8.....	129
CO.....	Green Pin® Omega Link EN 1677-1 GR8.....	130
MP.....	Green Pin® Pear Shaped Link EN 1677-4 GR8.....	130
MJ.....	Green Pin® Connecting Link EN 1677-1 GR8.....	131
COS.....	Green Pin® Round Web Sling Connector GR8.....	132
MJS.....	Green Pin® Round Web Sling Connecting Link GR8.....	133
UMS.....	Green Pin® Master Link GR10.....	134
UMTS.....	Green Pin® Master Link Assembly GR10.....	135
UCO.....	Green Pin® Omega Link GR10.....	136
UMP.....	Green Pin® Pear Shaped Link GR10.....	137
UMJ.....	Green Pin® Connecting Link GR10.....	138
UMJT.....	Green Pin Tycan® Connecting Link GR10.....	139
P-6810.....	DNV GL Master Link.....	140
P-6820.....	DNV GL Master Link Assembly.....	141
8	Swivels	
G-7713.....	Green Pin® EE Swivel.....	144
G-7723.....	Green Pin® JE Swivel CP.....	144
P-7740.....	Green Pin® Thrust Bearing EE Swivel.....	145
ELR.....	Green Pin® Needle Bearing Swivel EE GR8.....	146
UELR.....	Green Pin® Needle Bearing Swivel EE GR10.....	146
9	Hooks	
P-6714C.....	Green Pin® Hook E GR4.....	150
P-6714A.....	Green Pin® Hook E GR8.....	151
P-6703A.....	Green Pin® Hook SE GR8.....	152
P-6731.....	Green Pin® Pipe Line Hook.....	153
P-6706A.....	Green Pin® Alloy Sliding Choker Hook.....	153
CSO.....	Green Pin® Sling Hook E EN 1677-2 GR8.....	154
CSC.....	Green Pin® Sling Hook CL EN 1677-2 GR8.....	154
CSE.....	Green Pin® Sling Hook SE EN 1677-2 GR8.....	155



CSECA.....	Green Pin® Sling Hook SCL EN 1677-2 GR8.....	155
XLO.....	Green Pin® Self Locking Hook E EN 1677-3 GR8.....	156
XLC.....	Green Pin® Self Locking Hook EN 1677-3 CL GR8.....	156
GKO.....	Green Pin® Self Locking Hook E GR8.....	157
GKC.....	Green Pin® Self Locking Hook CL GR8.....	157
XLE.....	Green Pin® Self Locking Hook S EN 1677-3 GR8.....	158
GKE.....	Green Pin® Self Locking Hook S GR8.....	158
XLBA.....	Green Pin® Self Locking Hook SCL EN 1677-3 GR8.....	159
CRO.....	Green Pin® Grab Hook E EN 1677-1 GR8.....	160
CRC.....	Green Pin® Grab Hook CL EN 1677-1 GR8.....	160
GH.....	Green Pin® Excavator Hook GR8.....	161
CFO.....	Green Pin® Foundry Hook E GR8.....	161
CST.....	Green Pin® Flat Web Sling Hook GR8.....	162
XLS.....	Green Pin® Flat Web Sling Safety Hook GR8.....	162
UCSO.....	Green Pin® Sling Hook E GR10.....	163
UCSC.....	Green Pin® Sling Hook CL GR10.....	163
UXLO.....	Green Pin® Self Locking Hook E GR10.....	164
UXLC.....	Green Pin® Self Locking Hook CL GR10.....	164
UXLE.....	Green Pin® Self Locking Hook S GR10.....	165
UCRO.....	Green Pin® Grab Hook E GR10.....	166
UCRC.....	Green Pin® Grab Hook CL GR10.....	166
UCFO.....	Green Pin® Foundry Hook E GR10.....	167
UCRCT.....	Green Pin Tycan® Grab Hook CL GR10.....	167
UCSCT.....	Green Pin Tycan® Sling Hook CL GR10.....	168
P-6720A.....	Clevis Hook for Green Pin Tycan®.....	168
S.....	S-Hook.....	169
SO.....	S Eye Hook.....	169
CAC.....	Clevis lashing hook.....	170
10 Lifting Eyes		
AL.....	Green Pin® Lifting Eye GR8.....	175
ALDIN.....	Green Pin® Lifting Eye Length as DIN580 GR8.....	176
ALUNC.....	Green Pin® Lifting Eye UNC GR8.....	177
EL.....	Green Pin® Eye Nut GR8.....	178
ADA.....	Green Pin® Rotating Hoist Ring GR8.....	179
ADAUNC.....	Green Pin® Rotating Hoist Ring UNC GR8.....	180
ADAL.....	Green Pin® Long Rotating Hoist Ring GR8.....	181
OL.....	Green Pin® Small Lifting Eye GR8.....	182
PAS.....	Green Pin® Weld-On Transport Ring.....	183
E-8140.....	Eye bolts, generally to DIN 580.....	184
E-8142.....	Eye nuts, generally to DIN 582.....	185
11 Loadbinders		
P-7170.....	Green Pin® Ratchet Loadbinder HK EN 12195-3.....	188
P-7190.....	Green Pin® Ratchet Loadbinder EN 12195-3.....	189
P-7130.....	Green Pin® Ratchet Loadbinder HK.....	190
P-7150.....	Green Pin® Ratchet Loadbinder.....	191
P-7110.....	Green Pin® Lever Loadbinder HK.....	192
P-7180.....	Green Pin Tycan® Ratchet Loadbinder GR10.....	193
12 Chain		
CHAIN.....	Green Pin® Lifting Chain EN818-2 GR8.....	195
UCHAIN.....	Green Pin® Lifting Chain GR10.....	195
FCHLIFT.....	Green Pin Tycan® Lifting Chain.....	196
FCHLASH.....	Green Pin Tycan® Lashing Chain.....	196
E-7661.....	Short link chain.....	197
G-7662.....	Short link chain.....	197
E-7631.....	Long link chain.....	197
G-7632.....	Long link chain.....	197
13 Shortening Clutches		
GC.....	Green Pin® Shortening Clutch EN 1677-1 GR8.....	199
GCV.....	Green Pin® Shortening Clutch with Lock EN 1677-1 GR8.....	199
GDV.....	Green Pin® Shortening Clutch with Double Lock EN 1677-1 GR8.....	200
UGC.....	Green Pin® Shortening Clutch GR10.....	200
UGCV.....	Green Pin® Shortening Clutch with Lock GR10.....	201
UGDC.....	Green Pin® Shortening Clutch with Double Lock GR10.....	201
14 Lifting Clamps		
P-6615.....	Green Pin® Lifting Clamp V-type.....	204
P-6616.....	Green Pin BigMouth® Lifting Clamp V-type.....	204
P-6625.....	Green Pin® Lifting Clamp U-type.....	205
P-6626.....	Green Pin BigMouth® Lifting Clamp U-type.....	205
P-6635.....	Green Pin® Lifting Clamp H-Type.....	206



P-6636.....	Green Pin BigMouth® Lifting Clamp H-type.....	206
P-6685.....	Green Pin® Beam Lifting Clamp H-type.....	207
P-6686.....	Green Pin BigMouth® Beam Lifting Clamp H-type.....	207
15	Blocks	
P-6951.....	Green Pin® Snatch Block S.....	210
P-6952.....	Green Pin® Snatch Block HK.....	212
P-6953.....	Green Pin® Snatch Block.....	214
16	General Hardware	
TAGRFID.....	Green Pin® RFID Tag.....	217
CHIPRFID.....	Green Pin® RFID Chip.....	217
TAG.....	Green Pin® ID Tag.....	218
TAGF.....	Green Pin® ID Tag for Grade 8 Slings.....	219
UTAGF.....	Green Pin® ID Tag for Grade 10 Slings.....	219
E-7950.....	Split pins.....	220
E-7930.....	Spring pins, single type.....	222
E-7931.....	Spring pins, double type.....	223
E-7940.....	Linch pins.....	224
E-7300.....	Quick links, standard type.....	225
E-7310.....	Quick links, with enlarged opening.....	225
E-7200.....	Carabine hooks, standard type.....	226
E-7210.....	Carabine hooks, with pressed thimble.....	226
E-7220.....	Carabine hooks, with screw nut.....	227
17	Spare Parts	
VR.....	Green Pin® Self Locking Hooks GR8/GR10 Spare Kit.....	229
AC.....	Green Pin® Clevis Fittings GR8 Spare Kit.....	230
RMJ.....	Green Pin® Connecting Link Spare Kit GR8.....	231
LF.....	Green Pin® Latch GR8.....	232
RCOS.....	Green Pin® Clevis For Web Sling Connector GR8 Spare Kit.....	233
UAC.....	Green Pin® Clevis Fittings GR10 Spare Kit.....	234
URMJ.....	Green Pin® Connecting Link Spare Kit GR10.....	235
ULF.....	Green Pin® Latch GR10.....	236
UACT.....	Green Pin Tycan® Clevis Fittings GR10 Spare Kit.....	237
E-7910.....	Chain repair links.....	238
18	Stainless Steel Products	
MSI.....	Green Pin® Master Link S/S-GR5.....	242
MTSI.....	Green Pin® Master Link Assembly S/S-GR5.....	243
COI.....	Green Pin® Omega Link S/S-GR5.....	244
MJI.....	Green Pin® Connecting Link S/S-GR5.....	244
CSOI.....	Green Pin® Sling Hook E S/S-GR5.....	245
CSCI.....	Green Pin® Sling Hook CL S/S-GR5.....	245
CSEI.....	Green Pin® Sling Hook S S/S-GR5.....	246
CROI.....	Green Pin® Grab Hook E S/S-GR5.....	246
ALI.....	Green Pin® Lifting Eye S/S-GR5.....	247
ALDINI.....	Green Pin® Lifting Eye DIN580 length S/S-GR5.....	247
ELI.....	Green Pin® Eye Nut S/S-GR5.....	248
PASI.....	Green Pin® Weld-On Transport Ring S/S-GR5.....	248
TAGI.....	Green Pin® ID Tag S/S-GR5.....	249
ACI.....	Green Pin® Clevis Fittings S/S-GR5 Spare Kit.....	249
RMJI.....	Green Pin® Connecting Link S/S-GR5 Spare Kit.....	250
LFI.....	Green Pin® Latch S/S-GR5.....	250
CHAINI.....	Green Pin® Lifting Chain S/S-GR5.....	251
MLVI.....	Stainless steel bow shackle with screw pin.....	252
MDVI.....	Stainless steel dee shackle with screw pin.....	252
R-7825.....	Shackles, bow shackles with screw pin.....	253
R-7827.....	Shackles, bow shackles with safety bolt.....	253
R-7821.....	Shackles, dee shackles with screw pin.....	254
R-7823.....	Shackles, dee shackles with safety bolt.....	254
R-7860.....	Thimbles, heavy type.....	255
R-7863.....	Wire rope clips.....	255
R-7837.....	Open body rigging screws Hook-Hook.....	256
R-7838.....	Open body rigging screws Hook-Eye.....	256
R-7839.....	Open body rigging screws Eye-Eye.....	257
R-7830.....	Closed body rigging screws Jaw-Jaw.....	257
R-7877.....	Swivels.....	258
R-7840.....	Eye bolts.....	259
R-7842.....	Eye nuts.....	259
R-7873.....	Quick links, standard type.....	260
R-7874.....	Quick links, with enlarged opening.....	260
R-7872.....	Carabine hooks, standard type.....	261
R-7875.....	Carabine hooks, with pressed thimble.....	261



R-7876	Carabine hooks, with screw nut.....	262
R-7856	Cotter Pin.....	263
R-7850	Safety Pin.....	264
R-7852	Single Spring Pin.....	265
R-7854	Spring Pins.....	266
R-7880	Short link chain	267
R-7890	Long link chain.....	267

A		
Aluminium sleeves	A-6550.....	94
C		
Carabine hooks, standard type.....	E-7200.....	226
Carabine hooks, standard type.....	R-7872.....	261
Carabine hooks, with pressed thimble.....	E-7210.....	226
Carabine hooks, with pressed thimble.....	R-7875.....	261
Carabine hooks, with screw nut.....	E-7220.....	227
Carabine hooks, with screw nut.....	R-7876.....	262
Chain repair links.....	E-7910.....	238
Clevis Hook for Green Pin Tycan®.....	P-6720A.....	168
Clevis lashing hook.....	CAC.....	170
Closed body rigging screws Eye-Eye.....	G-6340.....	124
Closed body rigging screws Eye-Jaw.....	G-6345.....	125
Closed body rigging screws Jaw-Jaw.....	G-6343.....	124
Closed body rigging screws Jaw-Jaw.....	R-7830.....	257
Commercial Shackles – Bow shackle with counter sunk screw pin.....	E-1162.....	74
Commercial Shackles – Bow shackle with screw collar pin.....	E-1161.....	73
Commercial Shackles – Bow shackle with square head screw pin.....	S-1164.....	73
Commercial Shackles – Dee shackle with screw collar pin.....	E-1151.....	74
Commercial Shackles – Dee shackle with square head screw pin.....	S-1154.....	75
Cotter Pin.....	R-7856.....	263
D		
DNV GL Master Link.....	P-6810.....	140
DNV GL Master Link Assembly.....	P-6820.....	141
E		
Eye bolts.....	R-7840.....	259
Eye bolts, generally to DIN 580.....	E-8140.....	184
Eye nuts.....	R-7842.....	259
Eye nuts, generally to DIN 582.....	E-8142.....	185
F		
Fishing Shackles – Bow shackle with square head screw pin.....	P-3764.....	66
Fishing Shackles – Dee shackle with square head screw pin.....	P-3754.....	66
G		
Green Pin BigMouth® Beam Lifting Clamp H-type.....	P-6686.....	207
Green Pin BigMouth® Bow Shackle BN.....	G-4263.....	48
Green Pin BigMouth® Bow Shackle FN.....	G-4243.....	49
Green Pin BigMouth® Dee Shackle BN.....	G-4553.....	50
Green Pin BigMouth® Lifting Clamp H-type.....	P-6636.....	206
Green Pin BigMouth® Lifting Clamp U-type.....	P-6626.....	205
Green Pin BigMouth® Lifting Clamp V-type.....	P-6616.....	204
Green Pin Polar® Bow Shackle BN.....	G-5163.....	44
Green Pin Polar® Bow Shackle FN.....	G-5143.....	45
Green Pin Polar® Heavy Duty Bow Shackle BN.....	P-6031.....	46
Green Pin Polar® Heavy Duty Bow Shackle FN.....	P-6011.....	47
Green Pin Polar® JJ Turnbuckle BN.....	G-6333.....	113
Green Pin Power Sling® Shackle BN.....	P-6043.....	40
Green Pin Super® Bow Shackle BN.....	G-5263.....	42
Green Pin Super® Bow Shackle FN.....	G-5243.....	43
Green Pin Super® Bow Shackle SC.....	G-5261.....	41
Green Pin Tycan® Clevis Fittings GR10 Spare Kit.....	UACT.....	237
Green Pin Tycan® Connecting Link GR10.....	UMJT.....	139
Green Pin Tycan® Grab Hook CL GR10.....	UCRCT.....	167
Green Pin Tycan® Lashing Chain.....	FCHLASH.....	196
Green Pin Tycan® Lifting Chain.....	FCHLIFT.....	196
Green Pin Tycan® Ratchet Loadbinder GR10.....	P-7180.....	193
Green Pin Tycan® Sling Hook CL GR10.....	UCSCT.....	168
Green Pin® Alloy Sliding Choker Hook.....	P-6706A.....	153
Green Pin® Beam Lifting Clamp H-type.....	P-6685.....	207
Green Pin® Bow Shackle BN.....	G-4163.....	29
Green Pin® Bow Shackle FN.....	G-4143.....	30
Green Pin® Bow Shackle SC.....	G-4161.....	28
Green Pin® Clevis Fittings GR10 Spare Kit.....	UAC.....	234
Green Pin® Clevis Fittings GR8 Spare Kit.....	AC.....	230
Green Pin® Clevis Fittings S/S-GR5 Spare Kit.....	ACI.....	249
Green Pin® Clevis For Web Sling Connector GR8 Spare Kit.....	RCOS.....	233
Green Pin® Closed Spelter Socket.....	G-6411.....	99
Green Pin® Closed Swage Socket.....	S-6415.....	106
Green Pin® Compression Tool.....	P-5368.....	54



Green Pin® Connecting Link EN 1677-1 GR8	MJ	131
Green Pin® Connecting Link GR10	UMJ	138
Green Pin® Connecting Link S/S-GR5	MJI	244
Green Pin® Connecting Link S/S-GR5 Spare Kit	RMJI	250
Green Pin® Connecting Link Spare Kit GR10	URMJ	235
Green Pin® Connecting Link Spare Kit GR8	RMJ	231
Green Pin® D-handle	P-5396D	59
Green Pin® Dee Shackle BN	G-4153	32
Green Pin® Dee Shackle FN	G-4133	33
Green Pin® Dee Shackle SC	G-4151	31
Green Pin® EE Swivel	G-7713	144
Green Pin® EE Turnbuckle	G-6311	114
Green Pin® EH Turnbuckle	G-6314	119
Green Pin® EJ Turnbuckle	G-6315	117
Green Pin® Excavator Hook GR8	GH	161
Green Pin® Eye Nut GR8	EL	178
Green Pin® Eye Nut S/S-GR5	ELI	248
Green Pin® Fishing Bow Shackle FP	G-4169	64
Green Pin® Fishing Bow Shackle SQ	G-4164	62
Green Pin® Fishing Dee Shackle FP	G-4159	65
Green Pin® Fishing Dee Shackle SQ	G-4154	63
Green Pin® Fishtail handle	P-5396F	59
Green Pin® Flat Web Sling Hook GR8	CST	162
Green Pin® Flat Web Sling Safety Hook GR8	XLS	162
Green Pin® Foundry Hook E GR10	UCFO	167
Green Pin® Foundry Hook E GR8	CFO	161
Green Pin® Grab Hook CL EN 1677-1 GR8	CRC	160
Green Pin® Grab Hook CL GR10	UCRC	166
Green Pin® Grab Hook E EN 1677-1 GR8	CRO	160
Green Pin® Grab Hook E GR10	UCRO	166
Green Pin® Grab Hook E S/S-GR5	CROI	246
Green Pin® Guided Pin ROV Shackle D	P-5362D	57
Green Pin® Guided Pin ROV Shackle F	P-5362F	58
Green Pin® Heavy Duty Bow Shackle BN	P-6036	34
Green Pin® Heavy Duty Bow Shackle FN	P-6016	35
Green Pin® Heavy Duty Dee Shackle BN	G-6038	36
Green Pin® Heavy Duty Dee Shackle FN	G-6018	37
Green Pin® HH Turnbuckle	G-6312	116
Green Pin® Hook E GR4	P-6714C	150
Green Pin® Hook E GR8	P-6714A	151
Green Pin® Hook SE GR8	P-6703A	152
Green Pin® ID Tag	TAG	218
Green Pin® ID Tag for Grade 10 Slings	UTAGF	219
Green Pin® ID Tag for Grade 8 Slings	TAGF	219
Green Pin® ID Tag S/S-GR5	TAGI	249
Green Pin® JE Swivel CP	G-7723	144
Green Pin® JJ Turnbuckle BN	G-6323	111
Green Pin® JJ Turnbuckle CP	G-6313	110
Green Pin® Latch GR10	ULF	236
Green Pin® Latch GR8	LF	232
Green Pin® Latch S/S-GR5	LFI	250
Green Pin® Lever Loadbinder HK	P-7110	192
Green Pin® Lifting Chain EN818-2 GR8	CHAIN	195
Green Pin® Lifting Chain GR10	UCHAIN	195
Green Pin® Lifting Chain S/S-GR5	CHAINI	251
Green Pin® Lifting Clamp H-Type	P-6635	206
Green Pin® Lifting Clamp U-type	P-6625	205
Green Pin® Lifting Clamp V-type	P-6615	204
Green Pin® Lifting Eye DIN580 length S/S-GR5	ALDINI	247
Green Pin® Lifting Eye GR8	AL	175
Green Pin® Lifting Eye Length as DIN580 GR8	ALDIN	176
Green Pin® Lifting Eye S/S-GR5	ALI	247
Green Pin® Lifting Eye UNC GR8	ALUNC	177
Green Pin® Locking Clamp ROV Shackle	P-5365	52
Green Pin® Long Rotating Hoist Ring GR8	ADAL	181
Green Pin® Master Link Assembly EN 1677-4 GR8	MTS	129
Green Pin® Master Link Assembly GR10	UMTS	135
Green Pin® Master Link Assembly S/S-GR5	MTSI	243
Green Pin® Master Link EN 1677-4 GR8	MS	128
Green Pin® Master Link GR10	UMS	134
Green Pin® Master Link S/S-GR5	MSI	242
Green Pin® Needle Bearing Swivel EE GR10	UELR	146
Green Pin® Needle Bearing Swivel EE GR8	ELR	146
Green Pin® Omega Link EN 1677-1 GR8	CO	130



Green Pin® Omega Link GR10.....	UCO.....	136
Green Pin® Omega Link S/S-GR5.....	COI.....	244
Green Pin® Open Spelter Socket BN.....	G-6422.....	101
Green Pin® Open Spelter Socket CP.....	G-6412.....	100
Green Pin® Open Swage Socket CP.....	S-6414.....	105
Green Pin® Open Wedge Socket BN.....	G-6423.....	103
Green Pin® Open Wedge Socket CP.....	G-6413.....	102
Green Pin® Pear Shaped Link GR10.....	UMP.....	137
Green Pin® Pear Shaped Link EN 1677-4 GR8.....	MP.....	130
Green Pin® Pipe Line Hook.....	P-6731.....	153
Green Pin® Ratchet Loadbinder.....	P-7150.....	191
Green Pin® Ratchet Loadbinder EN 12195-3.....	P-7190.....	189
Green Pin® Ratchet Loadbinder HK.....	P-7130.....	190
Green Pin® Ratchet Loadbinder HK EN 12195-3.....	P-7170.....	188
Green Pin® RFID Chip.....	CHIPRFID.....	217
Green Pin® RFID Tag.....	TAGRFID.....	217
Green Pin® Rotating Hoist Ring GR8.....	ADA.....	179
Green Pin® Rotating Hoist Ring UNC GR8.....	ADAUNC.....	180
Green Pin® Round Web Sling Connecting Link GR8.....	MJS.....	133
Green Pin® Round Web Sling Connector GR8.....	COS.....	132
Green Pin® Self Locking Hook CL GR10.....	UXLC.....	164
Green Pin® Self Locking Hook CL GR8.....	GKC.....	157
Green Pin® Self Locking Hook E EN 1677-3 GR8.....	XLO.....	156
Green Pin® Self Locking Hook E GR10.....	UXLO.....	164
Green Pin® Self Locking Hook E GR8.....	GKO.....	157
Green Pin® Self Locking Hook EN 1677-3 CL GR8.....	XLC.....	156
Green Pin® Self Locking Hook S EN 1677-3 GR8.....	XLE.....	158
Green Pin® Self Locking Hook S GR10.....	UXLE.....	165
Green Pin® Self Locking Hook S GR8.....	GKE.....	158
Green Pin® Self Locking Hook SCL EN 1677-3 GR8.....	XLBA.....	159
Green Pin® Self Locking Hooks GR8/GR10 Spare Kit.....	VR.....	229
Green Pin® Short Bow Socket.....	G-6416.....	104
Green Pin® Shortening Clutch EN 1677-1 GR8.....	GC.....	199
Green Pin® Shortening Clutch GR10.....	UGC.....	200
Green Pin® Shortening Clutch with Double Lock EN 1677-1 GR8.....	GDV.....	200
Green Pin® Shortening Clutch with Double Lock GR10.....	UGDC.....	201
Green Pin® Shortening Clutch with Lock EN 1677-1 GR8.....	GCV.....	199
Green Pin® Shortening Clutch with Lock GR10.....	UGCV.....	201
Green Pin® Sling Hook CL EN 1677-2 GR8.....	CSC.....	154
Green Pin® Sling Hook CL GR10.....	UCSC.....	163
Green Pin® Sling Hook CL S/S-GR5.....	CSCI.....	245
Green Pin® Sling Hook E EN 1677-2 GR8.....	CSO.....	154
Green Pin® Sling Hook E GR10.....	UCSO.....	163
Green Pin® Sling Hook E S/S-GR5.....	CSOI.....	245
Green Pin® Sling Hook S S/S-GR5.....	CSEI.....	246
Green Pin® Sling Hook SCL EN 1677-2 GR8.....	CSECA.....	155
Green Pin® Sling Hook SE EN 1677-2 GR8.....	CSE.....	155
Green Pin® Sling Shackle BN.....	P-6033.....	38
Green Pin® Sling Shackle FN.....	P-6013.....	39
Green Pin® Small Lifting Eye GR8.....	OL.....	182
Green Pin® Snatch Block.....	P-6953.....	214
Green Pin® Snatch Block HK.....	P-6952.....	212
Green Pin® Snatch Block S.....	P-6951.....	210
Green Pin® Spring Pin ROV Shackle.....	P-5363.....	51
Green Pin® Spring Release ROV Shackle.....	P-5367.....	53
Green Pin® Sunken Hole Key.....	E-4170.....	64
Green Pin® Sunken Hole Key.....	E-4170.....	65
Green Pin® Tapered Pin ROV Shackle D.....	P-5361D.....	55
Green Pin® Tapered Pin ROV Shackle F.....	P-5361F.....	56
Green Pin® Theatre Shackle SC.....	P-4161T.....	61
Green Pin® Thrust Bearing EE Swivel.....	P-7740.....	145
Green Pin® Web Sling Shackle SC.....	P-5461.....	60
Green Pin® Weld-On Transport Ring.....	PAS.....	183
Green Pin® Weld-On Transport Ring S/S-GR5.....	PASI.....	248
Green Pin® Wire Rope Clip.....	G-6240.....	89

L		
Linch pins.....	E-7940.....	224
Long link chain.....	E-7631.....	197
Long link chain.....	G-7632.....	197
Long link chain.....	R-7890.....	267

M		
Mooring Shackles – Bow shackle with screw pin.....	S-1165.....	67



O		
Open body rigging screws Eye-Eye	R-7839	257
Open body rigging screws Hook-Eye.....	R-7838	256
Open body rigging screws Hook-Hook.....	R-7837	256
P		
Prescon sleeves	S-6500	93
Q		
Quick links, standard type	E-7300	225
Quick links, standard type	R-7873	260
Quick links, with enlarged opening.....	E-7310	225
Quick links, with enlarged opening.....	R-7874	260
R		
Rigging screws Eye-Eye.....	E-6351	120
Rigging screws Eye-Hook	E-6354	121
Rigging screws Hook-Hook.....	E-6352	120
Rigging screws Jaw-Jaw	E-6353	121
Rigging screws with Welding Ends.....	E-6355	122
S		
S Eye Hook.....	SO	169
S-Hook	S	169
Safety Pin.....	R-7850	264
Shackles generally to B.S. 3032 table 2	S-2751	72
Shackles generally to B.S. 3032 table 2	G-2751	72
Shackles generally to DIN 82101 type A	S-3351	68
Shackles generally to DIN 82101 type A	G-3351	68
Shackles generally to DIN 82101 type B.....	S-3352	68
Shackles generally to DIN 82101 type B.....	G-3352	68
Shackles generally to DIN 82101 type C	S-3356	69
Shackles generally to DIN 82101 type C	G-3356	69
Shackles, bow shackles with safety bolt	R-7827	253
Shackles, bow shackles with screw pin	R-7825	253
Shackles, dee shackles with safety bolt.....	R-7823	254
Shackles, dee shackles with screw pin	R-7821	254
Short link chain	E-7661	197
Short link chain	G-7662	197
Short link chain	R-7880	267
Single Spring Pin.....	R-7852	265
Split pins	E-7950	220
Spring Pins	R-7854	266
Spring pins, double type	E-7931	223
Spring pins, single type	E-7930	222
Stainless steel bow shackle with screw pin	MLVI	252
Stainless steel dee shackle with screw pin	MDVI.....	252
Swivels	R-7877	258
T		
Thimbles – According to DIN 3091	S-6134	80
Thimbles – Generally to DIN 3090	E-6135	81
Thimbles – Generally to DIN 3090	G-6135	81
Thimbles – Generally to DIN 6899 (B)	E-6131	79
Thimbles – Generally to DIN 6899 (B)	G-6131	79
Thimbles – Generally to EN 13411-1	G-6170	82
Thimbles – Generally to US Fed. Spec. FF-T-276b type III	G-6142	83
Thimbles – Heavy duty stub-end	G-6120	77
Thimbles – Heavy duty stub-end reinforced with welded fillet plate	G-6128	78
Thimbles – Pennant line type.....	G-6151	84
Thimbles – Standard commercial	E-6110	77
Thimbles – Tubular type.....	P-6190	85
Thimbles – Tubular type with welded plate	P-6195	85
Thimbles, heavy type.....	R-7860	255
Turnbuckles (hamburgers).....	S-6330	123
W		
Wire Rope Clip – Generally to DIN 741.....	E-6220	91
Wire Rope Clip – Generally to EN 13411-5 Type A.....	E-6260	90
Wire rope clips	R-7863	255
Y		
Yellow Pin Shackles – Bow shackle with safety bolt	G-3163	70
Yellow Pin Shackles – Bow shackle with screw collar pin.....	G-3161	70
Yellow Pin Shackles – Dee shackle with safety bolt	G-3153	71
Yellow Pin Shackles – Dee shackle with screw collar pin	G-3151	71

A		
A-6550	Aluminium sleeves	94
AC	Green Pin® Clevis Fittings GR8 Spare Kit	230
ACI	Green Pin® Clevis Fittings S/S-GR5 Spare Kit	249
ADA	Green Pin® Rotating Hoist Ring GR8	179
ADAL	Green Pin® Long Rotating Hoist Ring GR8	181
ADAUNC	Green Pin® Rotating Hoist Ring UNC GR8	180
AL	Green Pin® Lifting Eye GR8	175
ALDIN	Green Pin® Lifting Eye Length as DIN580 GR8	176
ALDINI	Green Pin® Lifting Eye DIN580 length S/S-GR5	247
ALI	Green Pin® Lifting Eye S/S-GR5	247
ALUNC	Green Pin® Lifting Eye UNC GR8	177
C		
CAC	Clevis lashing hook	170
CFO	Green Pin® Foundry Hook E GR8	161
CHAIN	Green Pin® Lifting Chain EN818-2 GR8	195
CHAINI	Green Pin® Lifting Chain S/S-GR5	251
CHIPRFID	Green Pin® RFID Chip	217
CO	Green Pin® Omega Link EN 1677-1 GR8	130
COI	Green Pin® Omega Link S/S-GR5	244
COS	Green Pin® Round Web Sling Connector GR8	132
CRC	Green Pin® Grab Hook CL EN 1677-1 GR8	160
CRO	Green Pin® Grab Hook E EN 1677-1 GR8	160
CROI	Green Pin® Grab Hook E S/S-GR5	246
CSC	Green Pin® Sling Hook CL EN 1677-2 GR8	154
CSCI	Green Pin® Sling Hook CL S/S-GR5	245
CSE	Green Pin® Sling Hook SE EN 1677-2 GR8	155
CSECA	Green Pin® Sling Hook SCL EN 1677-2 GR8	155
CSEI	Green Pin® Sling Hook S S/S-GR5	246
CSO	Green Pin® Sling Hook E EN 1677-2 GR8	154
CSOI	Green Pin® Sling Hook E S/S-GR5	245
CST	Green Pin® Flat Web Sling Hook GR8	162
E		
E-1151	Commercial Shackles – Dee shackle with screw collar pin	74
E-1161	Commercial Shackles – Bow shackle with screw collar pin	73
E-1162	Commercial Shackles – Bow shackle with counter sunk screw pin	74
E-4170	Green Pin® Sunken Hole Key	64
E-4170	Green Pin® Sunken Hole Key	65
E-6110	Thimbles – Standard commercial	77
E-6131	Thimbles – Generally to DIN 6899 (B)	79
E-6135	Thimbles – Generally to DIN 3090	81
E-6220	Wire Rope Clip – Generally to DIN 741	91
E-6260	Wire Rope Clip – Generally to EN 13411-5 Type A	90
E-6351	Rigging screws Eye-Eye	120
E-6352	Rigging screws Hook-Hook	120
E-6353	Rigging screws Jaw-Jaw	121
E-6354	Rigging screws Eye-Hook	121
E-6355	Rigging screws with Welding Ends	122
E-7200	Carabine hooks, standard type	226
E-7210	Carabine hooks, with pressed thimble	226
E-7220	Carabine hooks, with screw nut	227
E-7300	Quick links, standard type	225
E-7310	Quick links, with enlarged opening	225
E-7631	Long link chain	197
E-7661	Short link chain	197
E-7910	Chain repair links	238
E-7930	Spring pins, single type	222
E-7931	Spring pins, double type	223
E-7940	Linch pins	224
E-7950	Split pins	220
E-8140	Eye bolts, generally to DIN 580	184
E-8142	Eye nuts, generally to DIN 582	185
EL	Green Pin® Eye Nut GR8	178
ELI	Green Pin® Eye Nut S/S-GR5	248
ELR	Green Pin® Needle Bearing Swivel EE GR8	146
F		
FCHLASH	Green Pin Tycan® Lashing Chain	196
FCHLIFT	Green Pin Tycan® Lifting Chain	196



G		
G-2751	Shackles generally to B.S. 3032 table 2	72
G-3151	Yellow Pin Shackles – Dee shackle with screw collar pin	71
G-3153	Yellow Pin Shackles – Dee shackle with safety bolt	71
G-3161	Yellow Pin Shackles – Bow shackle with screw collar pin	70
G-3163	Yellow Pin Shackles – Bow shackle with safety bolt	70
G-3351	Shackles generally to DIN 82101 type A	68
G-3352	Shackles generally to DIN 82101 type B	68
G-3356	Shackles generally to DIN 82101 type C	69
G-4133	Green Pin® Dee Shackle FN	33
G-4143	Green Pin® Bow Shackle FN	30
G-4151	Green Pin® Dee Shackle SC	31
G-4153	Green Pin® Dee Shackle BN	32
G-4154	Green Pin® Fishing Dee Shackle SQ	63
G-4159	Green Pin® Fishing Dee Shackle FP	65
G-4161	Green Pin® Bow Shackle SC	28
G-4163	Green Pin® Bow Shackle BN	29
G-4164	Green Pin® Fishing Bow Shackle SQ	62
G-4169	Green Pin® Fishing Bow Shackle FP	64
G-4243	Green Pin BigMouth® Bow Shackle FN	49
G-4263	Green Pin BigMouth® Bow Shackle BN	48
G-4553	Green Pin BigMouth® Dee Shackle BN	50
G-5143	Green Pin Polar® Bow Shackle FN	45
G-5163	Green Pin Polar® Bow Shackle BN	44
G-5243	Green Pin Super® Bow Shackle FN	43
G-5261	Green Pin Super® Bow Shackle SC	41
G-5263	Green Pin Super® Bow Shackle BN	42
G-6018	Green Pin® Heavy Duty Dee Shackle FN	37
G-6038	Green Pin® Heavy Duty Dee Shackle BN	36
G-6120	Thimbles – Heavy duty stub-end	77
G-6128	Thimbles – Heavy duty stub-end reinforced with welded fillet plate	78
G-6131	Thimbles – Generally to DIN 6899 (B)	79
G-6135	Thimbles – Generally to DIN 3090	81
G-6142	Thimbles – Generally to US Fed. Spec. FF-T-276b type III	83
G-6151	Thimbles – Pennant line type	84
G-6170	Thimbles – Generally to EN 13411-1	82
G-6240	Green Pin® Wire Rope Clip	89
G-6311	Green Pin® EE Turnbuckle	114
G-6312	Green Pin® HH Turnbuckle	116
G-6313	Green Pin® JJ Turnbuckle CP	110
G-6314	Green Pin® EH Turnbuckle	119
G-6315	Green Pin® EJ Turnbuckle	117
G-6323	Green Pin® JJ Turnbuckle BN	111
G-6333	Green Pin Polar® JJ Turnbuckle BN	113
G-6340	Closed body rigging screws Eye-Eye	124
G-6343	Closed body rigging screws Jaw-Jaw	124
G-6345	Closed body rigging screws Eye-Jaw	125
G-6411	Green Pin® Closed Spelter Socket	99
G-6412	Green Pin® Open Spelter Socket CP	100
G-6413	Green Pin® Open Wedge Socket CP	102
G-6416	Green Pin® Short Bow Socket	104
G-6422	Green Pin® Open Spelter Socket BN	101
G-6423	Green Pin® Open Wedge Socket BN	103
G-7632	Long link chain	197
G-7662	Short link chain	197
G-7713	Green Pin® EE Swivel	144
G-7723	Green Pin® JE Swivel CP	144
GC	Green Pin® Shortening Clutch EN 1677-1 GR8	199
GCV	Green Pin® Shortening Clutch with Lock EN 1677-1 GR8	199
GDV	Green Pin® Shortening Clutch with Double Lock EN 1677-1 GR8	200
GH	Green Pin® Excavator Hook GR8	161
GKC	Green Pin® Self Locking Hook CL GR8	157
GKE	Green Pin® Self Locking Hook S GR8	158
GKO	Green Pin® Self Locking Hook E GR8	157
L		
LF	Green Pin® Latch GR8	232
LFI	Green Pin® Latch S/S-GR5	250



M		
MDVI.....	Stainless steel dee shackle with screw pin.....	252
MJ.....	Green Pin® Connecting Link EN 1677-1 GR8.....	131
MJI.....	Green Pin® Connecting Link S/S-GR5.....	244
MJS.....	Green Pin® Round Web Sling Connecting Link GR8.....	133
MLVI.....	Stainless steel bow shackle with screw pin.....	252
MP.....	Green Pin® Pear Shaped Link EN 1677-4 GR8.....	130
MS.....	Green Pin® Master Link EN 1677-4 GR8.....	128
MSI.....	Green Pin® Master Link S/S-GR5.....	242
MTS.....	Green Pin® Master Link Assembly EN 1677-4 GR8.....	129
MTSI.....	Green Pin® Master Link Assembly S/S-GR5.....	243
O		
OL.....	Green Pin® Small Lifting Eye GR8.....	182
P		
P-3754.....	Fishing Shackles – Dee shackle with square head screw pin.....	66
P-3764.....	Fishing Shackles – Bow shackle with square head screw pin.....	66
P-4161T.....	Green Pin® Theatre Shackle SC.....	61
P-5361D.....	Green Pin® Tapered Pin ROV Shackle D.....	55
P-5361F.....	Green Pin® Tapered Pin ROV Shackle F.....	56
P-5362D.....	Green Pin® Guided Pin ROV Shackle D.....	57
P-5362F.....	Green Pin® Guided Pin ROV Shackle F.....	58
P-5363.....	Green Pin® Spring Pin ROV Shackle.....	51
P-5365.....	Green Pin® Locking Clamp ROV Shackle.....	52
P-5367.....	Green Pin® Spring Release ROV Shackle.....	53
P-5368.....	Green Pin® Compression Tool.....	54
P-5396D.....	Green Pin® D-handle.....	59
P-5396F.....	Green Pin® Fishtail handle.....	59
P-5461.....	Green Pin® Web Sling Shackle SC.....	60
P-6011.....	Green Pin Polar® Heavy Duty Bow Shackle FN.....	47
P-6013.....	Green Pin® Sling Shackle FN.....	39
P-6016.....	Green Pin® Heavy Duty Bow Shackle FN.....	35
P-6031.....	Green Pin Polar® Heavy Duty Bow Shackle BN.....	46
P-6033.....	Green Pin® Sling Shackle BN.....	38
P-6036.....	Green Pin® Heavy Duty Bow Shackle BN.....	34
P-6043.....	Green Pin Power Sling® Shackle BN.....	40
P-6190.....	Thimbles – Tubular type.....	85
P-6195.....	Thimbles – Tubular type with welded plate.....	85
P-6615.....	Green Pin® Lifting Clamp V-type.....	204
P-6616.....	Green Pin BigMouth® Lifting Clamp V-type.....	204
P-6625.....	Green Pin® Lifting Clamp U-type.....	205
P-6626.....	Green Pin BigMouth® Lifting Clamp U-type.....	205
P-6635.....	Green Pin® Lifting Clamp H-Type.....	206
P-6636.....	Green Pin BigMouth® Lifting Clamp H-type.....	206
P-6685.....	Green Pin® Beam Lifting Clamp H-type.....	207
P-6686.....	Green Pin BigMouth® Beam Lifting Clamp H-type.....	207
P-6703A.....	Green Pin® Hook SE GR8.....	152
P-6706A.....	Green Pin® Alloy Sliding Choker Hook.....	153
P-6714A.....	Green Pin® Hook E GR8.....	151
P-6714C.....	Green Pin® Hook E GR4.....	150
P-6720A.....	Clevis Hook for Green Pin Tycan®.....	168
P-6731.....	Green Pin® Pipe Line Hook.....	153
P-6810.....	DNV GL Master Link.....	140
P-6820.....	DNV GL Master Link Assembly.....	141
P-6951.....	Green Pin® Snatch Block S.....	210
P-6952.....	Green Pin® Snatch Block HK.....	212
P-6953.....	Green Pin® Snatch Block.....	214
P-7110.....	Green Pin® Lever Loadbinder HK.....	192
P-7130.....	Green Pin® Ratchet Loadbinder HK.....	190
P-7150.....	Green Pin® Ratchet Loadbinder.....	191
P-7170.....	Green Pin® Ratchet Loadbinder HK EN 12195-3.....	188
P-7180.....	Green Pin Tycan® Ratchet Loadbinder GR10.....	193
P-7190.....	Green Pin® Ratchet Loadbinder EN 12195-3.....	189
P-7740.....	Green Pin® Thrust Bearing EE Swivel.....	145
PAS.....	Green Pin® Weld-On Transport Ring.....	183
PASI.....	Green Pin® Weld-On Transport Ring S/S-GR5.....	248
R		
R-7821.....	Shackles, dee shackles with screw pin.....	254
R-7823.....	Shackles, dee shackles with safety bolt.....	254
R-7825.....	Shackles, bow shackles with screw pin.....	253
R-7827.....	Shackles, bow shackles with safety bolt.....	253
R-7830.....	Closed body rigging screws Jaw-Jaw.....	257



R-7837	Open body rigging screws Hook-Hook	256
R-7838	Open body rigging screws Hook-Eye	256
R-7839	Open body rigging screws Eye-Eye	257
R-7840	Eye bolts	259
R-7842	Eye nuts	259
R-7850	Safety Pin	264
R-7852	Single Spring Pin	265
R-7854	Spring Pins	266
R-7856	Cotter Pin	263
R-7860	Thimbles, heavy type	255
R-7863	Wire rope clips	255
R-7872	Carabine hooks, standard type	261
R-7873	Quick links, standard type	260
R-7874	Quick links, with enlarged opening	260
R-7875	Carabine hooks, with pressed thimble	261
R-7876	Carabine hooks, with screw nut	262
R-7877	Swivels	258
R-7880	Short link chain	267
R-7890	Long link chain	267
RCOS	Green Pin® Clevis For Web Sling Connector GR8 Spare Kit	233
RMJ	Green Pin® Connecting Link Spare Kit GR8	231
RMJI	Green Pin® Connecting Link S/S-GR5 Spare Kit	250

S

S	S-Hook	169
S-1154	Commercial Shackles – Dee shackle with square head screw pin	75
S-1164	Commercial Shackles – Bow shackle with square head screw pin	73
S-1165	Mooring Shackles – Bow shackle with screw pin	67
S-2751	Shackles generally to B.S. 3032 table 2	72
S-3351	Shackles generally to DIN 82101 type A	68
S-3352	Shackles generally to DIN 82101 type B	68
S-3356	Shackles generally to DIN 82101 type C	69
S-6134	Thimbles – According to DIN 3091	80
S-6330	Turnbuckles (hamburgers)	123
S-6414	Green Pin® Open Swage Socket CP	105
S-6415	Green Pin® Closed Swage Socket	106
S-6500	Prescon sleeves	93
SO	S Eye Hook	169

T

TAG	Green Pin® ID Tag	218
TAGF	Green Pin® ID Tag for Grade 8 Slings	219
TAGI	Green Pin® ID Tag S/S-GR5	249
TAGRFID	Green Pin® RFID Tag	217

U

UAC	Green Pin® Clevis Fittings GR10 Spare Kit	234
UACT	Green Pin Tycan® Clevis Fittings GR10 Spare Kit	237
UCFO	Green Pin® Foundry Hook E GR10	167
UCHAIN	Green Pin® Lifting Chain GR10	195
UCO	Green Pin® Omega Link GR10	136
UCRC	Green Pin® Grab Hook CL GR10	166
UCRCT	Green Pin Tycan® Grab Hook CL GR10	167
UCRO	Green Pin® Grab Hook E GR10	166
UCSC	Green Pin® Sling Hook CL GR10	163
UCSCT	Green Pin Tycan® Sling Hook CL GR10	168
UCSO	Green Pin® Sling Hook E GR10	163
UCLR	Green Pin® Needle Bearing Swivel EE GR10	146
UGC	Green Pin® Shortening Clutch GR10	200
UGCV	Green Pin® Shortening Clutch with Lock GR10	201
UGDC	Green Pin® Shortening Clutch with Double Lock GR10	201
ULF	Green Pin® Latch GR10	236
UMJ	Green Pin® Connecting Link GR10	138
UMJT	Green Pin Tycan® Connecting Link GR10	139
UMP	Green Pin® Pear Shaped Link GR10	137
UMS	Green Pin® Master Link GR10	134
UMTS	Green Pin® Master Link Assembly GR10	135
URMJ	Green Pin® Connecting Link Spare Kit GR10	235
UTAGF	Green Pin® ID Tag for Grade 10 Slings	219
UXLC	Green Pin® Self Locking Hook CL GR10	164
UXLE	Green Pin® Self Locking Hook S GR10	165
UXLO	Green Pin® Self Locking Hook E GR10	164



V		
VR.....	Green Pin® Self Locking Hooks GR8/GR10 Spare Kit	229
X		
XLBA.....	Green Pin® Self Locking Hook SCL EN 1677-3 GR8	159
XLC.....	Green Pin® Self Locking Hook EN 1677-3 CL GR8	156
XLE.....	Green Pin® Self Locking Hook S EN 1677-3 GR8	158
XLO.....	Green Pin® Self Locking Hook E EN 1677-3 GR8	156
XLS.....	Green Pin® Flat Web Sling Safety Hook GR8	162

TABLE OF CONTENTS

- 1 Shackles
- 2 Thimbles
- 3 Wire Rope Clips
- 4 Sleeves
- 5 Sockets
- 6 Turnbuckles
- 7 Links
- 8 Swivels
- 9 Hooks
- 10 Lifting Eyes
- 11 Loadbinders
- 12 Chain
- 13 Shortening Clutches
- 14 Lifting Clamps
- 15 Blocks
- 16 General Hardware
- 17 Spare Parts
- 18 Stainless Steel Products

Go to <http://www.vanbeest.nl/general-terms-and-conditions> to read our general terms and conditions per sales office.

Green Pin®: the leading brand for premium quality chain and wire rope fittings in the world

- ✓ Premium quality lifting and lashing equipment
- ✓ Supplied with a range of certifications (e.g. DNV GL, Lloyd's)
- ✓ Unrivalled stock availability of 99%
- ✓ Comprehensive, worldwide support
- ✓ Available in over 90 countries worldwide

greenpin.com



Member of



Associated
Wire Rope
Fabricators



Member of Van Beest International

VAN BEEST B.V.

Head Office
Industrieweg 6
3361 HJ Sliedrecht
The Netherlands
Telephone +31 184 41 33 00
E-mail sales@vanbeest.nl

VAN BEEST GmbH

Märkische Straße 115/117
44141 Dortmund
Germany
Telephone +49 231 58 44 230
E-mail sales@vanbeest.de

VAN BEEST FRANCE S.A.S.

Route de Chanier
63250 Celles sur Durolle
France
Telephone +33 (0)4 73 51 89 51
E-mail sales@vanbeest.fr

VAN BEEST USA, L.L.C.

US main office
5615 W. Fuqua, Building B
Houston, TX 77085
United States

Chicago office
158 South Pinnacle Drive
Romeoville, IL 60446
United States

Telephone +1 713 674 57 53
E-mail sales.us@vanbeest.com